

RADIO'S LIVEST MAGAZINE



December
25 Cents
Canada 30c

Bosch Spantor
Radio-Craft
72 Chart Crowley 35

HUGO GERNSBACK Editor



**How to Make a
Battery-Operated,
Portable P. A. System**

See Page 330

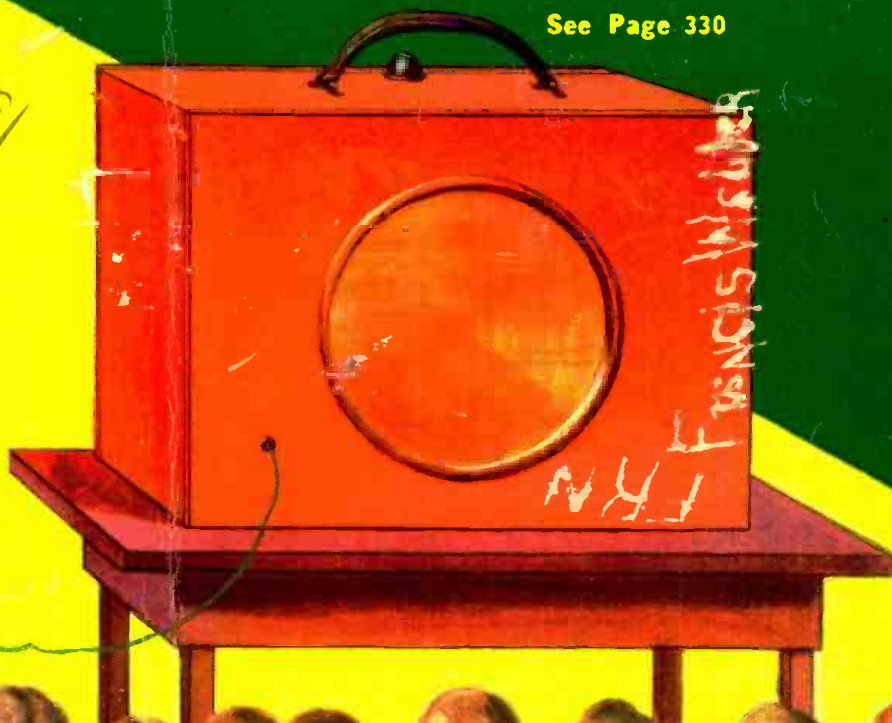

A Direct-Reading Mutual Conductance Meter—A 2-Volt Super-Remote-Control Tuning System—Noise Meters—I. F. Chart

SPEED

SPEED

SPEED



WHEN EFFICIENCY IS DEFINITELY LINKED WITH SKILL OF THE HIGHEST ORDER **AND**

WHEN HONOR IN MANUFACTURING IS A CORNERSTONE IN AN INSTITUTION **AND**

WHEN DETERMINATION TO PRODUCE MERCHANDISE OF MERIT IS AN UNSWERVING POLICY **AND**

JOINED WITH PROGRESSIVE RESEARCH

THEN ONLY IS THE RADIO PUBLIC EQUITABLY SERVED. **!!**



SPEED

POLICIES ASSURE THIS ALWAYS

TRIPLE-TWIN-TELEVISION-FOTO-LECTRIC TUBES

**WRITE FOR LATEST FREE BULLETIN—TURN TO PAGE 384A
FOR OUR CARD—KEEP UP WITH PROGRESS BY CONTACT WITH**

SPEED!

**CABLE RADIO TUBE CORP.
230-240 NO. NINTH ST. BROOKLYN, N.Y.**



**ARE YOU
"SET"
TO START
THE RACE TO
BETTER
TIMES
?**

The TRAINED MAN *always Wins!*

It's just as true—or even truer—in business as in sport. The man with real, practical TRAINING is the one to win. Now that business is returning to normal there's going to be a harder race to win the prizes of big-pay jobs, independence and a future, than ever before. Are you "all set" to race? Have you the necessary TRAINING to bring you in among the winners! If not, DON'T WAIT! Get the training NOW while there's still time!

Get Your Training for Work in Profitable **RADIO-TELEVISION** *in the Great Coyne School in Only 10 Weeks*

Here's the most fascinating, fastest-growing field in the world today. In Radio there are thousands of jobs paying BIG MONEY—up to \$50 a week and more. COYNE TRAINING fits you to hold better jobs—prepare to be a Designer, Inspector or Tester . . . a Radio Salesman, Service or Installation Man . . . Operator or Manager of a Broadcasting Station . . . a Wireless Operator on a Ship or Airplane . . . Coyne trains you, too, for Talk-

ing Picture and Television and Sound Work! In just a few short weeks, by exclusive Coyne methods, you are trained for a future that holds marvelous opportunities for top-notch salaries, or for a business of your own and real independence. Find out about this great game—get all particulars—see how simple it is for any ambitious man to get into it with the help of this great, nationally-recognized school.

LEARN BY DOING—NO BOOK STUDY

When you come to COYNE for training you start right in doing practical, interesting work on the greatest layout of Radio, Television and Sound Equipment you ever dreamed of seeing. Scores of the most up-to-minute Radio Receivers, real Broadcasting Equipment, latest Television Apparatus, Talking Picture and Sound Reproduction Equipment, Code Practice Equipment, etc., are here for you to use and learn by actual operation, servicing and repair. Previous experience or advanced education isn't needed. The useless theory—the tedious book study—is cut out by COYNE methods. We replace it with actual practice and experience in modern, completely equipped shops in our own huge building. The result is that you get more training in 10 weeks at COYNE than you ordinarily could in long months of tiresome book study.

Earn as You Learn — We'll Help You

Don't let lack of ready cash hold you back in getting the TRAINING you must have to be a winner. Many COYNE students make all or a good share of their living expenses while going to school. If you need that kind of help just let me know. We run an efficient Employment Service to help you get spare-time employment while you are here—and that aids you in finding full-time jobs whenever you need them during your whole life. COYNE has been training men for nearly a THIRD OF A CENTURY—its value has been tested and proven by thousands of men who are now successful and happy. YOU can have a future like that—YOU can be one of the winners in the race of life. Why not learn how easy it is?

SEND NOW FOR BIG FREE BOOK

Just mail the Coupon! It will bring you a thrilling big book, illustrated with actual photographs taken in COYNE SHOPS and showing how our methods TRAIN you so practically that employers are glad to have you if you have a background of COYNE TRAINING. This book tells you everything you want to know about the tremendous RADIO FIELD—describes the vast opportunities that exist in it—tells about the future in it for men who know. It's a book of FACTS that is more fascinating than fiction. You'll enjoy every word of it—and it may be the means of starting you on a real, successful, prosperous career. GET IT AT ONCE. Just mail the coupon!

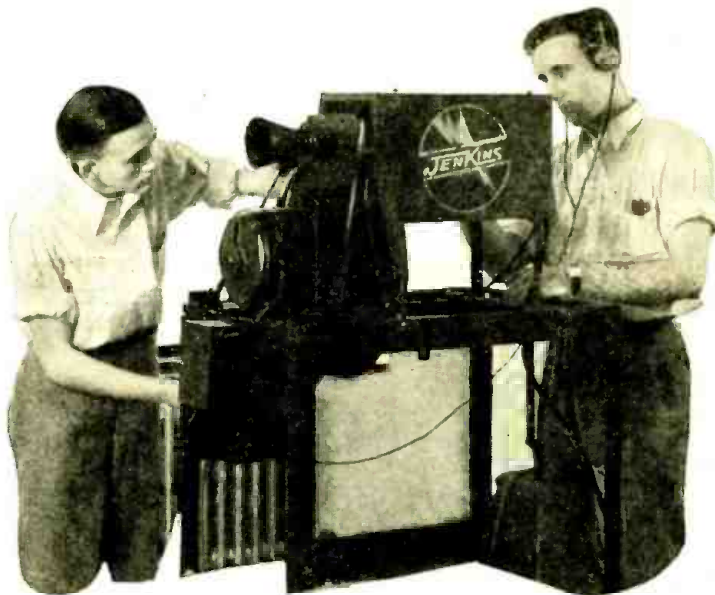

COYNE ELECTRICAL SCHOOL

H. C. LEWIS, President

Founded 1899

500 S. Paulina St.,

Dept. 92-8H

CHICAGO, ILL.

H. C. Lewis, President,

Radio Division, Coyne Electrical School,
500 S. Paulina St., Dept. 92-8H Chicago, Ill.

Dear Mr. Lewis: Send me your Big, FREE Radio Book, and tell me how I can get the TRAINING that will make me a WINNER.

NAME.....
ADDRESS.....
CITY.....STATE.....



HUGO GERNSBACK, Editor-in-Chief

LOUIS MARTIN
Associate Editor

R. D. WASHBURNE
Technical Editor

CONTENTS OF THE DECEMBER, 1932, ISSUE

VOLUME IV

NUMBER 6

EDITORIAL:

What Broadcasting Needs.....Hugo Gernsback 329

NEW DEVELOPMENTS IN RADIO:

How to Make a Battery-Operated, Portable P. A. System
Clifford E. Denton 330

The Latest Radio Equipment..... 332

New Tube Announcements..... Louis Martin 334

SERVICE MEN'S DEPARTMENT:

Building A Direct-Reading Mutual Conductance Meter
J. H. Potts 341

The Causes and Cures of Audio OscillationL. van der Mel 343

RADIO-CRAFT'S Chart of Intermediate Frequencies..... 344

Constructing Adapters for Test Equipment...F. L. Sprayberry 346

The Service Man's Forum..... 348

Operating Notes..... 349

RADIO SERVICE DATA SHEETS:

Bosch "Vibro-Power" Triple Action Model 312.....Vibro 350

Sparton "Triolian" 13-Tube Model 28..... 351

Short-Cuts in Radio Service..... 352

A Service Man's Proportional-Type Ohmmeter
Frank Zoltowski 384A

TECHNICAL RADIO TOPICS:

Building A Remote Control Tuning System.....C. H. West 336

How to Build the Savil Type 748 D. C. Kit Set
B. S. Vilkomerson 338

Constructing A 2-Volt Superheterodyne.....H. G. Cisin 340

Some Interesting Loudspeaker Facts.....Eli M. Lurie 342

"Ferrocart" R. F. Coils.....Albert Neuberger 345

How to Make Money With P. A. Systems.....Hubert L. Short 353

RADIO-CRAFT Kinks..... 354

The Radio Craftman's Page..... 355

Constructing the Triple-Twin S-W. Receiver.....H. Harrison 356

Information Bureau..... 358

Quasi-Optical Home Experiments.....John B. Brennan, Jr. 360

Book Review..... 361

How to Get "Java" on a P. A. System.....Paul Richards 384B

IN OUR NEXT FEW ISSUES:

A METERLESS TUBE TESTER. Since time immemorial it has been considered essential that one or more meters be included in the construction of a tube checker. In the "meterless" tube checker the author presents an instrument capable of testing practically all tubes—without recourse to any type of meter.

SET TESTING BY RESISTANCE MEASUREMENT. In this article the Service Man will find a practical discussion of the procedure to be followed in "resistance servicing." After a short discussion of the principles involved, the author conducts his readers through a series of tests on a standard, commercial, receiver chassis.

NEW TUBES—AND CIRCUITS. Interesting as have been previous articles in RADIO-CRAFT, on the design and use of new types of tubes, still newer designs present additional features to whet the interest of technicians. Not to know the features of these new electronic devices is to be "out in the cold" as regards progress of radio equipment development.

RADIO-CRAFT is published monthly, on the fifth of the month preceding that of date; its subscription price is \$2.50 per year. (In Canada and foreign countries, \$3.00 a year to cover additional postage.) Entered at the post office at Mt. Morris, Ill., as second-class matter under the act of March 3, 1879. Trademark and copyright by permission of Gernsback Publications, Inc., 98 Park Place, N. Y. C.

Text and illustrations of this magazine are copyright and must not be reproduced without permission of the copyright owners. We are also agents for WONDER STORIES and WONDER STORIES QUARTERLY. Subscription to these magazines may be taken in combination with RADIO-CRAFT at reduced Club rates. Write for information.

Copyright 1932. GERNSBACK PUBLICATIONS, INC.

HUGO GERNSBACK, President
S. GERNSBACK, Treasurer

J. M. HERZBERG, Vice-President
I. S. MANHEIMER, Secretary

Published by **TECHNI-CRAFT PUBLISHING CORPORATION.** Publication office: 404 N. Wesley Ave., Mount Morris, Illinois. Editorial and Advertising Office: 96-98 Park Place, New York City. Chicago Advertising Office: 737 North Michigan Avenue, Chicago, Ill. Western Advertising Office: 220 No. Catalina St., Los Angeles, Calif. L. F. McClure, Chicago Advertising Representative. Loyd B. Chappell, Western Advertising Representative.

London Agent: Hachette & Cie., 3 La Belle Sauvage, Ludgate Hill, E.C. 4
Paris Agent: Hachette & Cie.,
111 Rue Reaumur
Australian Agent: McGill's Agency
179 Elizabeth St., Melbourne

AROUND THE WORLD RECEPTION A CERTAINTY



GERMANY
ENGLAND
FRANCE
SPAIN
RUSSIA
CHINA
SOUTH AMERICA
AUSTRALIA

Every Day
in the Year

with the New
15-550 METER

SCOTT
ALL-WAVE
Deluxe

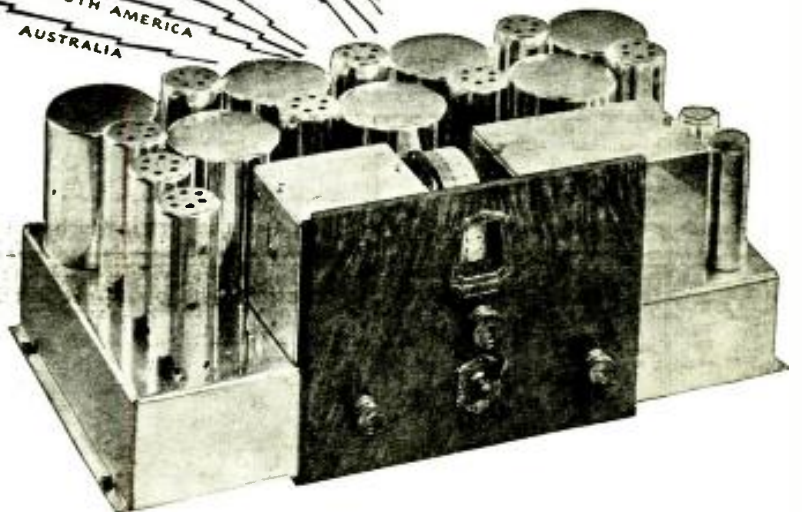

SCOTT-TRAVEL to the ends of the earth! Spin the whole globe's wealth of entertainment into your own home with the twirl of a dial. True single dial control does it — no trimmers or auxiliary dials, no fussing with plug-in or tapped coils. Here is performance so perfected that this receiver is **GUARANTEED** to bring in foreign stations, 10,000 miles or more away, with full loud speaker volume in all seasons, every week throughout the year.

Guarantee Based on History's Most Impressive Radio Performance Record

Verified Chicago reception, by a SCOTT ALL-WAVE operating under ordinary home conditions, of every scheduled program broadcast over a whole year's time from VK2ME, Sydney, Australia—more than 9,500 miles away . . . more than 19,000 logs of foreign stations submitted by SCOTT ALL-WAVE owners this year . . . are but two of many accomplishments.

It takes advanced, precision engineering—laboratory technique in custom construction—a background of nearly a decade of experience in building superfine receivers—to make such records possible, and to permit such a guarantee.

Yet here it is! Try it yourself. Thrill to the reception of stations in England—France—Germany—Spain—Italy—South America—far-off Australia. Listen in on gabbing telephony amateurs—hear land-to-plane messages—foreign news flashes on the short waves—a dozen and one new radio thrills await you. Get American, Canadian and Mexican stations you've never dreamed were on the air. Get them *all*—even those thousands of miles away—with full loud speaker volume and lifelike fidelity of tone. Tone so perfect

that, in studio tests, music critics fail to distinguish between the actual playing of a hidden pianist, and the SCOTT ALL-WAVE DELUXE reproduction of a pianist's broadcast program.

Such performance results from micrometer-measured accuracy in custom building. It testifies to the incorporation of every worthwhile development in radio, plus many exclusive innovations made by Scott engineers. These betterments include full automatic volume control; visual tuning; the ultimate in selectivity; highest degree of sensitivity ever developed in a radio receiver; lowest known noise level of reception; new Class "A" linear amplification giving tremendous volume without distortion; new-type tubes; many other absorbingly interesting technical achievements.

Still, with all these superiorities, a SCOTT ALL-WAVE DELUXE costs no more than many models of ordinary receivers. And it is the *only* receiver with an iron-clad warranty. Every part (except tubes) is guaranteed for five years against breakage or service failure, instead of the ordinary 90-day period.

Learn about this new wonder of the radio world! The set that not only gets 'round-the-globe reception, but that is used around the world—Scott owners in 75 different foreign countries enjoy this remarkable performance. The whole story of the SCOTT ALL-WAVE DELUXE is the most vitally interesting news of radio quality, performance and value ever published. Get it today! Mail the coupon below for complete information, including technical data, performance proofs, and everything you want to know.

SEND COUPON NOW FOR PROOF

E. H. SCOTT RADIO
LABORATORIES, INC.
4450 Ravenswood Ave.,
Dept. C-122 Chicago, Illinois

Send me complete information about the New Scott All-Wave Deluxe Receiver, including technical details, performance proofs, prices, etc. This request is not to obligate me in any way.

Name.....
Address.....
City.....
State.....

E. H. SCOTT RADIO LABORATORIES, INC.
4450 Ravenswood Avenue Dept. C-122 CHICAGO, ILL.

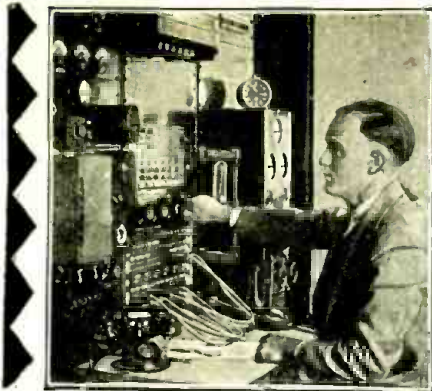

Broadcasting Stations employ trained men continually for jobs paying up to \$5,000 a year.



Police Departments are finding Radio a great aid in their work. Many good jobs have been made in this new field.



Spare time set servicing pays many N.R.I. men \$200 to \$1,000 a year. Full time men make as much as \$65, \$75, \$100 a week.

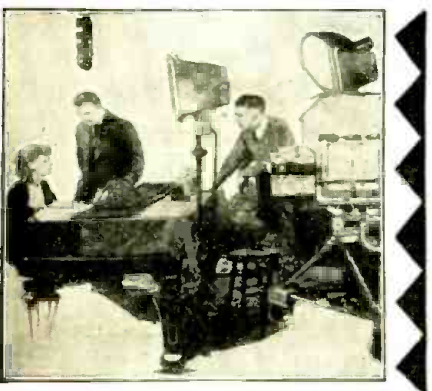

Talking Movies—an invention made possible by Radio—employs many well trained radio men for jobs paying \$75 to \$200 a week.



Television—the coming field of many great opportunities—is covered by my course.

I WILL TRAIN YOU AT HOME

Many Make \$50 to \$100 a Week in Radio -- *the Field With a Future*

My book, "Rich Rewards in Radio," gives you full information on the opportunities in Radio and explains how I can train you quickly to become a Radio Expert through my practical Home Study training. It is free. Clip and mail the coupon NOW. Radio's amazing growth has made hundreds of fine jobs which pay \$50, \$60, \$75, and \$100 a week. Many of these jobs may quickly lead to salaries as high as \$125, \$150, and \$200 a week.

Radio—the Field With a Future

Ever so often a new business is started in this country. You have seen how the men and young men who got into the automobile, motion picture, and other industries when they were started had the first chance at the big jobs—the \$5,000, \$10,000, and \$15,000 a year jobs. Radio offers the same chance that made men rich in those businesses. It has already made many men independent and will make many more wealthy in the future. You will be kicking yourself if you pass up this once-in-a-lifetime opportunity for financial independence.

Many Radio Experts Make \$50 to \$100 a Week

In the short space of a few years 300,000 Radio jobs have been created, and thousands more will be made by its future development. Men with the right training—the kind of training I will give you in the N.R.I. Course—have stepped into Radio at 2 and 3 times their former salaries. Experienced service men as well as beginners praise N.R.I. training for what it has done for them.

Many Make \$5, \$10, \$15 a Week Extra In Spare Time Almost At Once

My Course is world-famous as the one "that pays for itself." The day you enroll I send you material, which you should master quickly for doing 28 Radio jobs common in most every neighborhood. Throughout your Course I will show you how to do other repair and service jobs on the side for extra money. I will not only show you how to do the jobs but how to get them. I'll give you the plans and ideas that have made \$200 to \$1,000 a year for N.R.I. men in their spare time. G. W. Page, 110 Raleigh Apts., Nashville, Tenn., writes: "I made \$935 in my spare time while taking your Course." My book, "Rich Rewards in Radio," gives many letters from students who earned four, five, and six times their tuition fees before they graduated.

Get Ready Now for Jobs Like These

Broadcasting stations use engineers, operators, station managers and pay up to \$5,000 a year. Radio manufacturers employ testers, inspectors, foremen, engineers, service men, buyers, and managers for jobs paying up to \$6,000 a year. Radio dealers and jobbers (there are over 35,000) employ service men, salesmen, buyers, managers and pay up to \$100 a week. Talking pictures pay as much as \$75 to \$200 a week to men with Radio training. There are hundreds of opportunities for you to have a spare time or full time Radio business of your own—to be your own boss. I'll show you how to start your own business with practically no capital—how to do it on money made in spare time while learning. My book tells you of other opportunities. Be sure to get it at once. Just clip and mail the coupon.

I HAVE STARTED MANY IN RADIO AT 2 AND 3 TIMES



**\$400.00
Each
Month**

"I spent fifteen years as traveling salesman and was making good money but could see the opportunities in Radio. Believe me I am not sorry, for I have made more money than ever before. I have made more than \$100 each month and it really was your course that brought me to this. I can't say too much for N.R.I."—J. G. Dahlstead, Radio Sta. KYA, San Francisco, Cal.



**\$800.00
In Spare
Time**

"Money could not pay for what I got out of your course. I did not know a single thing about Radio before I enrolled, but I have made \$800 in my spare time although my work keeps me away from home from 6:00 A.M. to 7:00 P.M. Every word I ever read about your course I have found true."—Milton I. Leiby, Jr., Tipton, Pennsylvania.



**Chief
Engineer
Station WOS**

"I have a nice position and am getting a good salary as Chief Engineer of Radio Station WOS. Before entering Radio, my salary was barely \$1,000.00 a year. It is now \$2,400.00 a year. Before entering Radio, my work was, more or less, a drudgery—it is now a pleasure. All of this is the result of the N.R.I. training and study. You got me my first important position."—H. H. Lance, Radio Station WOS, Jefferson City, Missouri.

TO BE A RADIO EXPERT

Act Now --- Mail Coupon Below for Free Book of Facts and Proof

You Learn at Home in Your Spare Time to be a Radio Expert

Hold your job. There is no need for you to leave home. I will train you quickly and inexpensively during your spare time. You don't have to be a high school or college graduate. My Course is written in a clear, interesting style that most anyone can grasp. I give you practical experience under my 50-50 method of training—one-half from lesson books and one-half from practical experiments with equipment given without extra charge. This unique and unequalled method has been called one of the greatest developments in correspondence Radio training. N.R.I. pioneered and developed it. It makes learning at home easy, fascinating, practical.

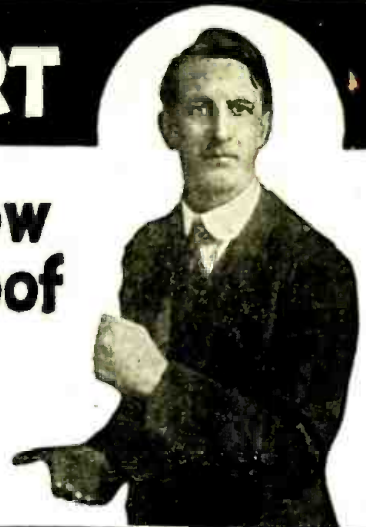

Special FREE Offer



Act now and receive in addition to my big free book "Rich Rewards in Radio," this Service Manual on D. C., A. C. and Battery Operated sets. Only my students could have this book in the past. Now readers of this magazine will receive it free. Overcoming hum, noises of all kinds, fading signals, broad tuning, howls and oscillations, poor distance reception, distorted or muffled signals, poor Audio and Radio Frequency amplification and other vital service information is contained in it. Get a free copy by mailing the coupon below. ACT NOW.

Learn the Secrets of Short Wave, Television, Talking Pictures, Set Servicing, Broadcasting, etc.

I'll give you more training than you need to get a job—I'll give you your choice, and not charge you extra either, of my Advanced Courses on these subjects—(1) Television, (2) Set Servicing and Merchandising, (3) Sound Pictures and Public Address Systems, (4) Broadcasting, Commercial and Ship Radio Stations, (5) Aircraft Radio. Advanced specialized training like this gives you a decided advantage.

Your Money Back if You are Not Satisfied

I will give you an agreement in writing, legal and binding upon this Institute, to refund every penny of your money upon completing my Course if you are not satisfied with my Lessons and Instruction Service. The resources of the National Radio Institute, Pioneer and World's Largest Home-Study Radio School stands behind this agreement.

Find Out What Radio Offers. Get My Book

One copy of my valuable 64-page book, "Rich Rewards in Radio," is free to any resident of the U. S. and Canada over 15 years old. It has started hundreds of men and young men on the road to better jobs and a bright future. It has shown hundreds of men who were in blind alley jobs, how to get into easier, more fascinating, better paying work. It tells you where the good Radio jobs are, what they pay, how you can quickly and easily fit yourself to be a Radio Expert. The Coupon will bring you a copy free. Send it at once. Your request does not obligate you in any way. ACT NOW.

J. E. SMITH, President
Dept. 2NX, National Radio Institute
Washington, D. C.

FORMER PAY



Experienced Radio Man Praises N. R. I. Course

"Before taking your course, I had worked at Radio for over seven years, doing quite a bit of servicing, but I realized that I was in need of better training. From the first lesson on I began to understand points that had me wondering. The course has taught me what I could not have learned otherwise and I would not take many times the price it has cost me, for the knowledge I have gained. In a period of nine months I have made at least \$3,500."—C. J. Stegner, 23 So. Sandusky St., Delaware, Ohio.



SPECIAL Radio Equipment for Broad Practical Experience Given Without Extra Charge

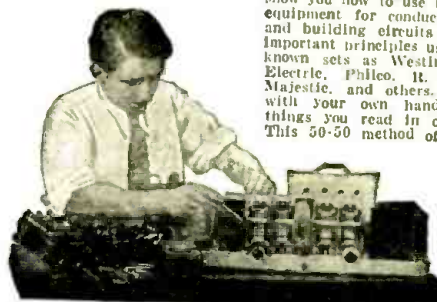

My Course is not all theory. I'll show you how to use my special Radio equipment for conducting experiments and building circuits which illustrate important principles used in such well-known sets as Westinghouse, General Electric, Philco, It. C. A., Victor, Majestic, and others. You work out with your own hands many of the things you read in our lesson books. This 50-50 method of training makes learning at home easy, interesting, fascinating, intensely practical.

Clip and mail NOW for FREE INFORMATION

J. E. SMITH, President
National Radio Institute, Dept. 2NX
Washington, D. C.

Dear Mr. Smith: I want to take advantage of your Special Offer. Send me your manual "Short Wave Receivers and Transmitters" and your book "Rich Rewards in Radio," which explains Radio's Opportunities for bigger pay and your method of training men at home in spare time. I understand this request does not obligate me.

Name

Address

City..... State.....

"M"

New! Last Minute Adapter and Analyzer Equipment

← Here's what you have been looking for!



Forty in One Adapter Change

950XYL

Here's what you have been looking for—nothing like it—highgrade tube checking adapter—tests over 40 tubes. No leads—no jacks or plug—no complicated directions. Resistances and toggle switch for instant reading of both plates of dual plate tubes—beautifully and ruggedly made—a typical Na-ald product. List \$6.00. Servicemen's postpaid price \$3.75. Orders filled in sequence received. Do not delay—send order today. Tubes it will check in practically any checker are 19, 29, 33, 36, 37, 38, 39, 41, 42, 44, 46, 47, 49, 52, 55, 57, 58, 59, 64, 65, 67, 68, 69, 70, 80, 82, 83, 85, 88, 89, 93, 95, 985, 986, G-2, G-4, LA, PA, PZ, PZH, Wunderlich A and B. No. 950XYL, Servicemen's price \$3.75 postpaid.

For Those Who Want Individual Tube Checking Adapters Here Are Some of the Newest



975KP tests the seven prong tubes in the 27 checker socket. **975KP** List Price \$1.00



965KS tests the 57 and 58 in the 24 checker socket and the 89 in the 36 checker socket. **965KS** List Price \$1.00



982 tests the 82, 83, 88, 985 and 986 m.v. rectifiers—has protective resistance and toggle switch for testing both plates. **982** List Price \$3.00



955G-2 tests the C2, C4, G2 and G4 duodiode tubes—has protective resistance network and toggle switch for testing each plate. **955G-2** List Price \$3.00



965-55 tests the 55 in 24 and the 85 in 36 checker socket. Both triode and diodes are tested. Has protective resistance network. **965-55** List Price \$3.00



965CG tests 57, 58 and PZH in 24 checker socket and 41, 42, 89, and PA in 36 checker socket. **965CG** List Price \$1.25



954KPC tests 33, 49; 46, 47, PZ; 52, LA in 30; 45; 71A checker sockets. **954KPC** List Price \$1.00

Send stamp for chart showing adapters best suited for the instruments you have. Chart includes adapters for all makes of instruments and all types of tubes.

INSIDE FACTS Testing Seven Prong Tubes

Upon the advent of six-prong tubes, instrument manufacturers shifted almost immediately to six prong analyzer plugs. Now that a seven-prong tube has been announced, there is the question whether there is going to be a seven-prong analyzer plug available. We have designed such a plug to have ready at such time as seven-prong sockets become the dominant socket, or when a seven-prong tube is produced with a control grid cap on the top.

In the meantime, there are some very definite disadvantages in having a seven-prong analyzer plug. It would mean that almost invariably the analyzer plug would have to be used with an adapter. This added length would in instances be a disadvantage in closely shielded sets and others built in limited space.

In addition to this, new sets are appearing in accordance with the rules of the Board of Fire Underwriters in which there is a shield having only a 1-32 in. clearance between it and the tube base. To meet these conditions analyzer plugs made in cooperation with the engineers of the test equipment companies have been designed so that the analyzer plugs and the associated adapters in every instance will not have a greater diameter than the smallest tube base of a given number of prongs.

The same engineering and care has been given to the design of Na-ald Adapters. The combined knowledge of the leading instrument manufacturers and our own. Tube manufacturers contribute and both present and future possibilities are taken into consideration. Thus Na-ald Adapters are correct, give dependable tests, avoiding damage to tubes and delicate equipment.

Various adapters are built with current limiting resistors. Where tubes have more than one element requiring checking they are provided with toggle switches that both plates or sections of such tubes may be tested. These points are important to you as the first cost of an adapter is lost forgotten in the continued service that it must give without injury to tubes and expensive instruments.

M. ALDEN.

Here Are the New Analyzer Plugs and Adapters for the New 6 and 7 Prong Tubes



The 906WL is the last word in an analyzer plug. Its diameter and height are proportioned so that there will be no difficulty in using it in the small base tube sockets or those equipped with the new close-fitting shields. The plug has a latch actuated by a spring which locks the associated adapters to the plug so that the adapter cannot stick in an inaccessible socket.



906WL List Price... \$3.50



906WLC Above with five feet of seven wire cable with the seventh wire connected to both control-grid studs and the latch \$5.50



964DS 6 hole to 4 prong adapter with locking stud \$1.25



965DS 6 hole to 5 prong adapter with locking stud \$1.25



967SS 6 hole to 7 prong adapter with locking stud connected to control-grid prong \$1.25



967SGL 6 hole to 7 prong adapter with locking stud. Control-grid prong connected to lead with clip for attaching to control-grid stud on analyzer plug. \$1.50

Readrite Owners

If you have endeavored to analyze the new sets just out you have found the need of small diameter analyzer plugs and adapters. Also if you are going to use adapters with your present equipment they will need to be small space.

Change your equipment over to the Alden Analyzer Plug and Na-ald Adapters and avoid being disappointed.

Servicemen's discount 35%—if order amounts to \$6.00, discount is 40%—Send for catalog.

Revamp the Old Set Analyzer and Tube Checker or Build a New One Using the New Na-ald Latch-Lock Analyzer Plug and Universal Sockets

Revamp the old set analyzer and tube checker or build a new one with the new Na-ald Latch Lock Analyzer Plugs and Universal Sockets. See articles on new analyzers by Denton and Sprayberry in Radio Craft, Clin, Gerber, Shalleross and Van Leuven in Radio News and Bernard in Radio World. Watch for coming articles using Na-ald Plugs and Universal Sockets.

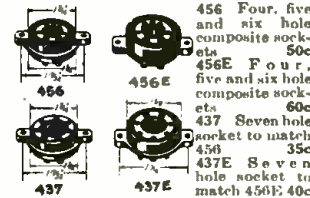

456 Four, five and six hole composite sockets 50c
456E Four, five and six hole composite sockets 60c
437 Seven hole socket to match 456 35c
437E Seven hole socket to match 456E 40c
456 and **437** are used in new equipment or to provide six and seven prong sockets without adding additional socket holes to present equipment. **456E** and **437E** are a size of socket found in some of the older test equipment.



These are the fine brilliantly colored latching sockets appearing in some of the newest and most advanced checkers and analyzers, 4, 5, 6, and 7 contacts.



Small Space Sockets. Holes for mounting can all be drilled with hand drill. Also used in making adapters 4-5-6-7 contacts.



Here are real labor try sockets—yet inexpensive—4-5-6-7 contacts.



Here are plugs of all styles and types, male or female, 4, 5, 6 or 7 contacts for speaker extensions or microphone, battery, analyzer and testing cables.

Adapters for Using the New Tubes in Your Present Set

954-47 replaces 45 tubes with 46 or 47 pentodes 50c
965-58 replaces 24 tubes with 57 or places the 58 in a 35 or 51 socket 50c
927 replaces Kellogg overhead heater type tubes with the 27 \$1.25
419X places the 2 volt tubes in old UV sockets .35c
999 places any UX-base tube in a UV199 socket 75c

Here Are Adapters That Make it Possible to Use the UY Plug of Your Analyzer for 6 and 7 Prong Tubes



Here are twin adapters which make it possible to use older analyzers for pentodes, 6 and 7 pin tubes.



974 Analyzes pentode circuits with screen grid analyzers. **974** List price \$2.50
965DW analyzes 6 prong tube circuit with screen grid analyzers. **965DW** List price \$2.50



975DW analyzes 7 prong tube circuits with screen grid analyzers. **975DW** List price \$2.50

If central locking stud to fit Na-ald Latch Lock plug is desired add "S" to any above numbers.



The genuine Makalot Coil Forms with color-code ring. Red-yellow-blue-green. List price 4 and 5 prongs 25c each 6 prongs 30c each

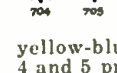

Precision wound shortwave coils—20 to 200 meters with .00014 mfd. condenser. **704SWS** Set of four coils \$2.00

Precision wound broadcast coils 100-540 meters with .00014 mfd. condenser **704SWW 704SWO** Set of two coils \$1.50



Practice Code Set. Adjustable pitch buzzer. Makalot base with code molded in. Alden Code Set. List price 75c

Send 10c for 26 page data sheets—300 diagrams of adapters for every purpose—description, use and directions are given. Tube terminals of the new tubes are shown, adapters for pickups, microphones, output meters, tone control, shortwave converters, etc.



Alden Mfg. Co., Dept. R, 715 Center St., Brockton, Mass.



The Season's Big Radio Sensation!

16-TUBE ALL-WAVE ^{only} 39.95

Completely Assembled with Large DUAL SPEAKERS

All the New 1933 FEATURES

WHAT a radio! One complete 16-tube chassis with one dual-ratio dial—new Super-Heterodyne circuit with a range of 15 to 550 meters STAT-OMIT Tuning Silencer New Class "B" Push-Push Power Amplifier Color-Lite Tuning Full band automatic Volume Control Duplex Duo-Diode Detection Dual-Ratio Single Dial No Trimmers. No Plug-in Coils, No Tuning meter or Neon light required Fractional Microvolt Sensitivity Dual Powered (2 separate power Transformers) Absolute Tone Fidelity 18 Tuned Circuits New Mercury Rectifier Full-Floating Variable Condenser Low Operating Cost and many other sensational new features. The new Midwest 16-tube set actually uses less current than previous sets of 8 and 10 tubes. A bigger, better, more powerful, more selective, finer toned radio than you've ever seen before offered at an amazingly low price direct from the big Midwest factory. Mail the coupon or send name and address on a postal for catalog and complete details.

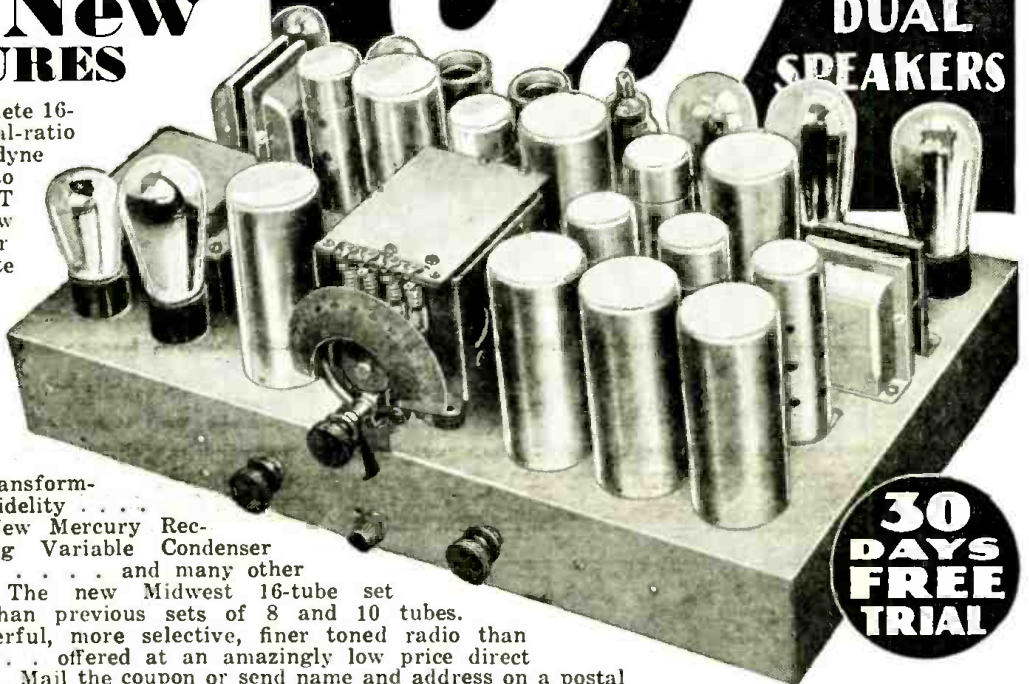

30 DAYS FREE TRIAL

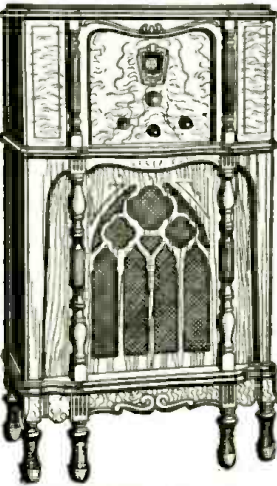

Complete Line of New Consoles

The big new Midwest catalog shows gorgeous line of artistic consoles in the new six-leg designs. Mail the coupon now. Get all the facts. Learn how you can save 30% to 50% on a big powerful radio by ordering direct from the factory.

DEAL DIRECT WITH FACTORY!

Don't be satisfied with less than a Midwest 16-tube A. C. radio. A receiver covering only the regular broadcast waves is *only half a set*. Improvements in short-wave programs have made ordinary broadcast sets obsolete. The Midwest gives you regular, foreign, police and amateur broadcasts in one single dial set. No converter or any extra units required. Remember, you buy DIRECT FROM THE MAKERS. No middlemen's profits to pay. You get an absolute guarantee of satisfaction or money back. You try any Midwest 30 DAYS before you decide to keep it. Then, if you wish, you can pay in small monthly amounts that you'll scarcely miss. Mail coupon for full details or write us a postal.

Read These Letters From Midwest Owners

Just two of the *thousands* of letters praising Midwest Radios.
 Gets France, Spain, Italy, Japan
 "Have received foreign short-wave stations such as FYA, France; EAQ, Madrid, Spain; 12 IG, Rome, Italy; and last but not least JIAA, Tokyo, Japan. I really think the Midwest set is a miracle."
 A. F. GRIDLEY, Sarasota, Fla.

W8XK—W3XAL—W1XAZ—W2XAF
 "I am very much satisfied in every way with my Midwest radio. I heard Sydney, Sunday 3:00 A. M. Also W8XK, W3XAL, W1XAZ, W2XAF in the evening. On the regular band have some 55 stations so far."
 Aug. Balbi, 1427 Myra Ave., Los Angeles, Calif.

Investigate! Mail Coupon NOW!

Get the Midwest catalog. Learn the facts about Midwest 9, 12 and 16-tube ALL-WAVE sets. Learn about our sensationally low factory prices, easy payment plan and positive guarantee of satisfaction or money back. Don't buy any radio until you get the big new Midwest catalog. Just sign and mail the coupon or send name and address on a postal.

MIDWEST RADIO CORPORATION
DEPT. 157 (Est. 1920) CINCINNATI, OHIO

Remember!

Every Midwest set is backed by a positive guarantee of satisfaction or your money back. 30 DAYS FREE TRIAL in your own home makes you the sole judge. Midwest, now in its twelfth successful year, offers bigger, better, more powerful, more sensitive radios at lower prices than ever before. The coupon or a postal brings you big new catalog and complete information. Mail it NOW!

SAVE UP TO 50%

TERMS as Low as \$5.00 DOWN

RUSH THIS COUPON FOR AMAZING FREE TRIAL OFFER AND BIG BEAUTIFUL CATALOG

Midwest Radio Corp.
 Dept. 157
 Cincinnati, Ohio

Without obligation on my part send me your new 1933 catalog, and complete details of your liberal 30-day free trial offer. This is NOT an order.

Name _____ Address _____ Town _____ State _____

USER AGENTS Easy EXTRA MONEY!
 Check here for details

The first of a series of advertisements devoted to companies outstanding for their engineering efforts and recognized as leaders in their respective field—Number One—TOBE—Radio Noise Suppression.



FILTERIZERS

lick your worst enemy

MAN-MADE S·T·A·T·I·C



The TOBE FILTERIZER KIT, as shown above, and easily installed
STOPS ALL RADIO NOISES

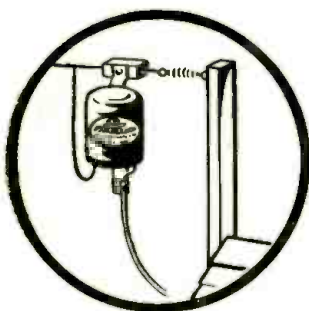

ON THE AERIAL

Filterette RF-1 connects antenna with shielded lead-in wire.

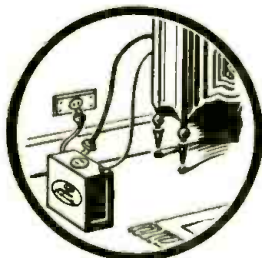

ON THE SET

Line Filterette RF-2 prevents noises from entering set by way of the power line.

TOBE FILTERIZER enables the listener to enjoy noise free radio reception. It keeps out of the set "man-made" static, resulting from motors, flashing signs, and other electrical apparatus. It has been tested by us on all makes of radio and under all conditions and has demonstrated its value.

You can easily install the TOBE FILTERIZER kit which includes:

- 1 Antenna Unit—RF-1
 - 1 Line Filterette—RF-2
 - 75 Ft. of Filterized Shielded Lead-in
- Complete, Ready to Install, \$9.75

When you buy a TOBE product to stop radio noise you obtain equipment which is the result of years of concentrated engineering effort. Everyone in the radio industry is familiar with what the TOBE people have done—to make radio reception better. The position of FIRST is conceded by all, and no finer tribute has ever been paid any company—than to have its work and products endorsed and recommended by the most prominent radio and electrical manufacturers. Such companies as Atwater Kent, Audiola, Clarion, Crosley, Philco, RCA Victor, General Electric, Sparks-Withington, Wright DeCosta, Zenith, and others, are included in this list.

We are proud to be one of the distributors for the FILTERIZER. It is soundly engineered, and the issue of the bulletins on filterizing principles which are made available to all dealers by the Tobe Deutschmann Corporation is just one of the many reasons why we consider this product so excellent. The FILTERIZER is not a "gadget." You must know how to use it and if anyone can tell us HOW and if anyone KNOWS HOW, it is TOBE DEUTSCHMANN.



DISTRIBUTORS IN
RADIO PARTS ONLY

NEWARK ELECTRIC Co.
"Nothing But Radio"
226 WEST MADISON STREET
CHICAGO,
ILLINOIS

Your Discount is 40%
Deposit Required with All Orders



"Takes the Resistance Out of Radio"

WHAT BROADCASTING NEEDS

An Editorial by HUGO GERNSBACK

THE thoughtful observer of radio broadcasting in the United States must have long since come to the conclusion that our manner of broadcasting leaves much to be desired. In the first place, there is entirely too much duplication of features between stations. At the present time of writing, there are actually some 650 odd radio broadcast stations in the United States alone, aside from Canada and Mexico, where there are still more stations.

Large as the United States are, there is not room to operate all these stations at the present time and give the service they should give, for obvious reasons. All you have to do is tune in a dozen different stations during any given evening, and it will become apparent that there is a fearful amount of duplication. You will find the same song being plugged by dozens of different stations. You will find the same sort of features duplicated countless times. For instance, you will get jazz in different forms from stations too numerous to mention. You will get crooners from a like amount. You will get instrumental music, organ music, symphonic and other music in vast profusion, all emanating from different stations.

If you are the average listener, you may, for example, be interested in classical music. At the present time, in order to get it, you must twist the knob of your set until such time when you find such music. Often, during a given period, there may not be any classical music, and if you have no printed program before you, which often happens, you are at a loss to know whether there will be any such music on the air that evening or not. Perhaps in a half hour you try again, and likely as not you butt into the midst of a classical program and you are annoyed because you did not know when it started.

If you have a printed program, it is somewhat simpler, but very often the printed program does not give you all the information you want. Then, too, to the great annoyance of listeners, American stations have a fond habit of switching programs around. They cancel one program and put on another. If an important political speaker is on the air, as for instance the President or presidential candidates, as we have at this time of the year, then all other programs go by the wayside and so the printed program is not of much use.

A visitor from Mars on an excursion to the United States, after having investigated radio broadcasting for a few evenings, would perhaps scratch his head thoughtfully and ask himself if the inhabitants of the earth had all gone out of their minds. Perhaps he could not understand the haphazard working of our stations, and he might ask questions about it, but no sane reply would be forthcoming.

After all, the problem is a simple one if the Radio Commission could be prevailed upon to do something about it, and it would not be so very difficult to solve it, either. Disregarding the key stations of the national broadcasting nets, as well as the stations connected with the networks, we still have left a fearful amount of stations which duplicate many features that are on the networks. Suppose the Radio Commission were to license independent stations, not affiliated with networks, for *only one type of program*? Suppose,

in a given city, there are six stations of which two are network stations? This would leave four other stations. The Radio Commission would say to these four stations that thereafter station A would be permitted *only* to broadcast jazz and light music; station B would *only* broadcast classical music, heavy music, etc.; station C would *only* have educational talks or educational features, of which there are a great variety; station D would be used for vocal music *only*. In localities where there are more than six stations, excellent uses could be found for the others.

This would be the ideal arrangement; to give the broadcast listener a service which he does not get now. He would then know in advance, when tuning-in any station, what sort of entertainment or service he could expect from it. If he wanted jazz, he would tune-in a "jazz station"; if he wanted dance music, he would tune-in a station that would give him nothing but dance music. If he wanted educational talks, he would know where to get them, without twiddling the knobs of his set futilely. In other words, we would have a situation where the listener could, at any time, get what he wanted without having to jump over to the set every fifteen minutes and switch to another station.

Of course, I can see where most broadcasters would throw up their hands in horror at such a suggestion because they cannot conceive of one station giving one sort of entertainment to the exclusion of all others. Yet, the plan has its great advantage in that such a station would become expert in its line, and could give *real* service which it does not and cannot give today. If you listen in to any of the smaller, independent stations today, nine out of ten programs are distinctly mediocre, to put it mildly. We have poor music, poor talks, and poor singers as a rule, and only the chain-affiliated stations, with the exception of a few of the larger independents, give good features. The smaller stations have no chance at all to give a real service to the listener. They have the poorest bands and the poorest singers and entertainers. All this could be changed if each station were only to broadcast one type of program. They would soon learn to do this one thing well.

Nor would their commercial interests fare worse than now. The advertising talks interspersed between the features would remain just the same. The advertiser is interested in *coverage*; he can get it just as well from an audience listening to an educational talk as from an audience listening to a crooner.

The trouble with the independent and smaller broadcasters today is that they are ill-fitted for the job simply because they do not specialize. If they specialized in one field they would do a lot better, and what is more, they would really serve the public.

If this recommendation were followed, the constant talk about too many stations would not be so serious; and if a station performs a real service, which many do not do today, the Radio Commission would think twice before depriving such stations of their licenses.

I predict that if some such plan is not adopted, the Radio Commission will find it necessary during the next ten years to reduce drastically the number of stations that are on the air.

HOW TO MAKE A BATTERY-OPERATED, PORTABLE P. A. SYSTEM

Complete constructional details of a battery-operated, portable P. A. system that is simple, economical and entirely self-contained

CLIFFORD E. DENTON

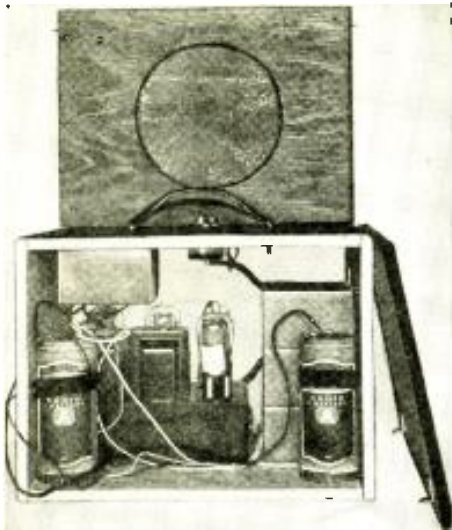

Fig. A
Internal view of the system with the front cover, which holds the speaker, removed and placed on top.



Fig. B
Photograph of the amplifier itself. The cable connects to the batteries housed in the case.

PUBLIC address equipment finds its way into many fields as the stage, pulpit, auditorium; even the front steps of the village post office (around election time) offer distinct possibilities.

Most systems offered are dependent for their power supply upon electric-light sockets. This is a condition which limits the field of use for such equipment and enables RADIO-CRAFT to present the first constructional article

on a system which may be set up anywhere, entirely independent of local power-supply conditions.

This outfit is ideal for the speaker or lecturer who makes short visits to small towns; speaking under conditions that would tax his voice, this amplifier can be used as a voice booster and permit voice conservation. If a phonograph is handy, then the pickup can be used to supply music for intermissions or for dancing.

As a calling system for use in offices, this system offers excellent possibilities. Quick-heating tubes and a simple switching combination for turning on the "mike" current at the same time the filament current for the tubes is applied, provides instantaneous service, and current is consumed from the batteries only when in use.

Design Factors

The amplifier proper consists of three stages of amplification, and has many interesting features. For example, the input transformer has windings for high impedance phonograph pickup, single or double-button microphone, and a high impedance winding used to feed the grid of the first tube which is a '32 tube of the screen-grid type.

A high audio gain in the first stage is necessary to raise the volume level

to a value sufficient to swing the grid of the second stage which works as a voltage amplifier and semi-power stage. The tube used in this second stage is a '33 power pentode. A tube of this type was selected for use because a certain amount of power is needed to drive the output stage and any other tube which could be used would not have the voltage gain required. A high gain is necessary in this stage for several reasons, the most important being that the input, push-pull transformer has a step down ratio and some of the available signal voltage will be lost in the transfer to the grids of the output stage. The output power of the '33 is about 700 milliwatts, and the voltage gain in this circuit is almost 14. In most cases, the type of tube used as a driver for a class B connection must determine the design of the interstage coupling transformer, and because of the high power output of the '33, a transformer was selected with a low turns ratio. This permits less voltage loss in the coupling transformer with sufficient power to drive the output tubes to near their maximum power output.

The output stage has two of the new class B tubes known as the ER-49. Ratings and characteristics are as follows: Filament voltage, 2.0; filament current, .12-amp.

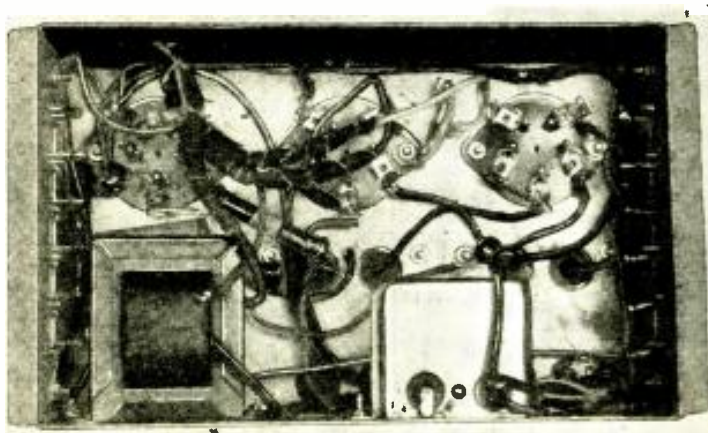

Fig. C
Under chassis view. The diagram of Fig. 2 shows exactly where the individual parts are placed.

YOU SHOULD BUILD THIS P. A. SYSTEM BECAUSE

- It may easily be constructed at home by anyone;
- It is entirely self-contained—no external apparatus;
- Public Address systems are in demand everywhere;
- No large outlay of cash is necessary, the total cost of the device is about twenty-five dollars, complete (without microphone);
- You want to make more money in the radio game;
- You WILL make more money in radio by building THIS BATTERY-OPERATED, PORTABLE P. A. SYSTEM

As a class B amplifier: Plate voltage, 180; grid bias (both grids), 0; plate current (zero signal), 4 ma.; plate current (peak per tube), 50 ma.; optimum load resistance (per tube), 3,000 ohms; optimum load resistance (plate to plate), 12,000 ohms; power output (two tubes), 3.5 watts.

As a class A amplifier: Plate and outer-grid voltage, 135; grid bias (inner grid), .20 volts; plate current, 5.7 ma.; amplification factor, 4.5; plate resistance, 4,000 ohms; mutual conductance, 1,125 micromhos; power output, 170 milliwatts.

Note that the filament consumption of these tubes is low. Two of them consume less current than one of the '33 type output tubes. Power from the "B" supply is drawn in proportion to the signal supplied to the grid of the output stage. Thus, with no signal, the plate current drain of the output stage is 4 ma.; with a signal applied, the plate current will rise, at times, to 20 ma. But because this drain is not constant, small size "B" batteries can be used and still give satisfactory life.

The output transformer has a center-tapped primary and offers four values of output impedances suitable for matching most any type of speaker. A connection strip on the side of the chassis permits the selection of either 9-, 15-, 500- or 4,000-ohm windings for proper output matching.

Current for the microphone is supplied by tapping off 1.5 volts of the filament supply battery. If a single-button microphone is used, connect leads from the "mike" to input terminals 4 and 5. Double button "mikes" are connected in the conventional manner to terminals 3 and 5 (from the button terminals) and from terminal 4 to the common connection of both buttons.

Volume control is obtained by varying the position of the slider arm of potentiometer 8 of Fig. 1. This is a simple, low-cost method to use, and does not affect the frequency characteristic of the input audio transformer except at very low volume levels. Practical experience indicates the average setting of this control will be about half-way on.

Terminals 1 and 2 of the input strip are connected to the high impedance winding of the input transformer. This winding is suitable for matching a high impedance phonograph pickup to the grid of the tube. This gives better frequency response and greater gain whenever it is desired to use the amplifier in conjunction with a phonograph.

The construction of the completed system must be divided into two sections: The wooden carrying case; and the chassis of the amplifier, which is made of iron and painted black with a quick-drying enamel.

A detailed drawing covering the construction of the case is shown in Fig. 3 and in Fig. A. If the builder cannot make the box, it is wise to turn the job over to a carpenter so as to

(Continued on page 364)

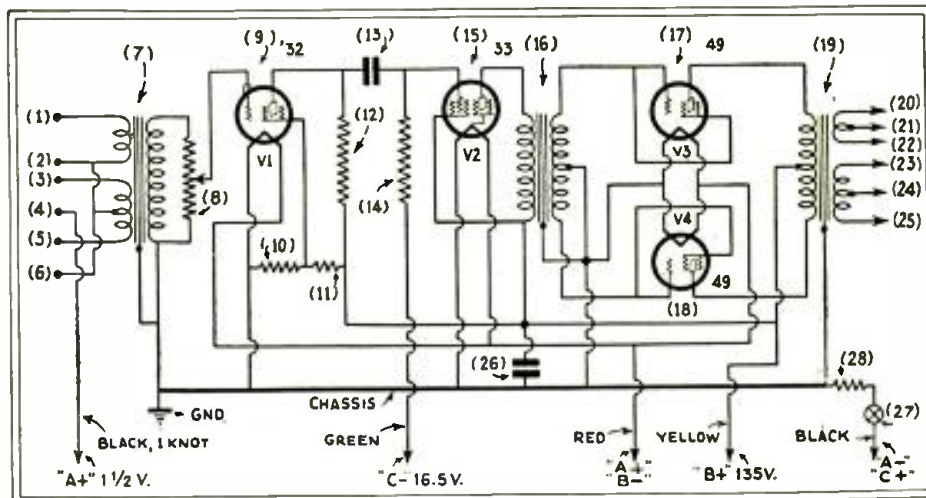

Fig. 1
Complete schematic of the amplifier. The reference numbers are used in the List of Parts and in the sketch of Fig. 2.

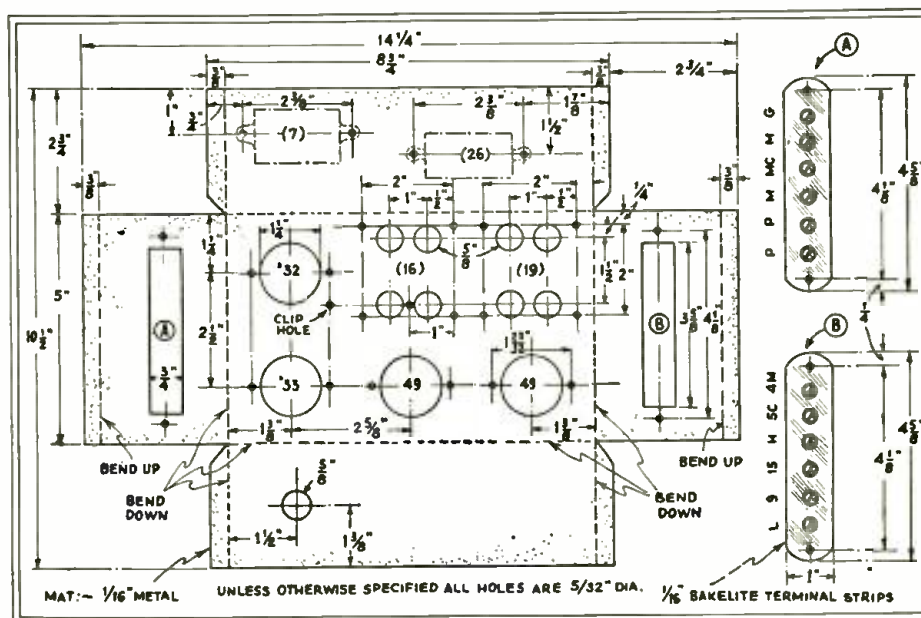

Fig. 2
Complete chassis layout of the amplifier. The two terminals labeled P,P connect to phonograph pickup; M and MC to a single-button microphone; M, MC, and M to a double-button microphone; and G to ground. Terminals L and 9 connect to a 9-ohm load; terminals L and 15 to a 15-ohm load; H and 5C to a 500-ohm load; and H and 4M to a 4,000-ohm load.

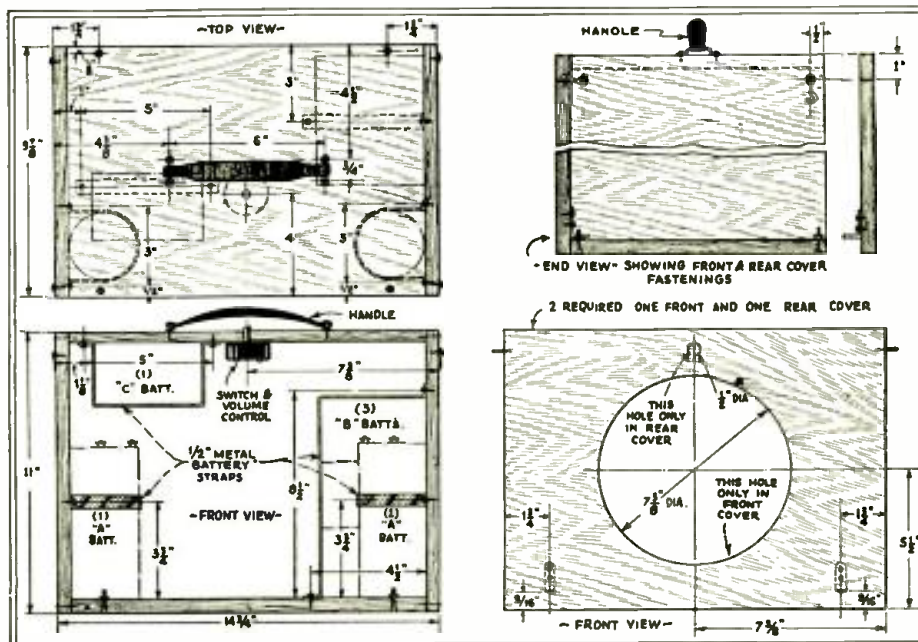

Fig. 3
Details of construction of the box for the system.

THE LATEST RADIO EQUIPMENT

NEW NA-ALD ADAPTER

THE adapter shown in Fig. 1 is a product of the Alden Manufacturing Co., and is designed to test the latest tubes in conjunction with tube testers and analyzers. As may be seen, the adapter has a five-prong base which connects through a suitable switching arrangement to the four sockets on top. The type 82 and 83 tubes are tested in

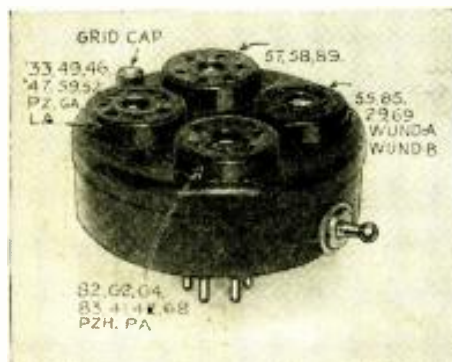

Fig. 1
The new Na-Ald adapter used for testing all new tubes.

the four-prong socket (each plate tested in turn by means of the toggle switch); Grigsby-Grunow type G-2 and G-3 tubes in the UY socket; and 41 and 42 tubes in the six-prong socket. One of the sockets is a combination 6- and 5-prong; in the five-prong socket, all pentode, 46, 49, and 52 class B tubes are tested. The type 59 tube is tested in the seven-prong socket. Facilities are also included for testing the 29, 55, 57, 58, 69, 85, and 89 tubes.

NOISE ELIMINATOR

STATISTICS, obtained by leading radio engineers, show that most of the noise picked up by the average broadcast receiver is due to the lead-in. In order to minimize this noise pickup, Ames, Aceves and King have developed a matching transformer, shown in Fig. 2, which is inserted between the antenna and the shielded lead-in, as pictured. The lower lead-in impedance reduces noise.

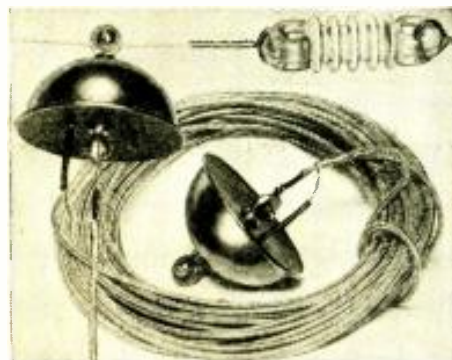

Fig. 2
The noise-free antenna equipment by Ames, Aceves and King. A shielded lead-in is used.

READRITE PLUG

IN line with the campaign for modernizing old set and tube testers, the Readrite Meter Works announces a new line of adapters suitable for such work. Fig. 3 illustrates a new plug to be used at the end of tester cables for testing all new tubes.

Of particular significance is the latch which is especially useful. The plug shown is known as the type 66 and may be used with Readrite or any other type set tester.

TESTER PLUG

THIS, and the past two issues of RADIO-CRAFT have contained descriptions of adapters suitable for modernizing almost any type of tester. The device shown in (1) of Fig. 4 is a photograph of one of the units. It has a five-prong base and a six-hole top; a 6-inch lead projecting from the socket facilitates connection to the tube cap.

NATIONAL S.W. COILS

ITEM (2) of Fig. 4 is one of a new series of S. W. coils produced by the National Company. Since the advent of the new 57 and 58 type tubes, there has been very little data available on coil construction suitable for these tubes. The coil shown has a primary, secondary and tickler winding, and connections are made to a six-prong base. Thus the coil may be used as either an antenna coil, or R.F. transformer with or without regeneration. The same coil is suitable for both the 57 and 58 type tubes. A National socket must be used, since the pin spacings are not standard.

AN S.W., R.F. CHOKE

SHORT-WAVE chokes have always been a problem. The National Co. has solved this problem by designing the unique choke shown in (3) of Fig. 4. It consists of four narrow sections, each universal wound, spaced on an Isolantite form. Although the chokes are supplied with stiff leads for mounting, they may be placed in standard grid-leak clips.

LAPEL MICROPHONE

ITEM (4) of Fig. 4 is a photograph of a new lapel microphone manufactured by the Miles Reproducer Co. They are made in 100- and 200-ohm sizes to suit individual conditions; a two-button type is also made. It is finished in high chromium; weighs approximately two ounces; and the stretched diaphragm is of a special alloy which is finished with a 22½-karat gold plating. It is sensitive; works with 2 to 8 ma.; and has a flat frequency-response curve.

UNIVERSAL SOCKET

A UNIVERSAL socket, taking four-, five-, and six-prong tubes is one of the latest items by Na-Ald. This universal socket is shown in Fig. 4, item (5). While most set testers are equipped to handle four- and five-prong tubes, they sometimes require so many adapters that the adapters weigh more than the tester itself!

The socket illustrated, then, is suitable for installation in all types of equipment that continually use multi-prong tubes. The fact that it saves space is obvious.

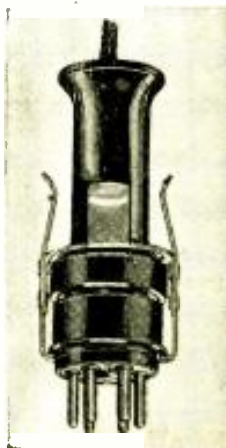

Fig. 3, above
The new Readrite plug with special latch.

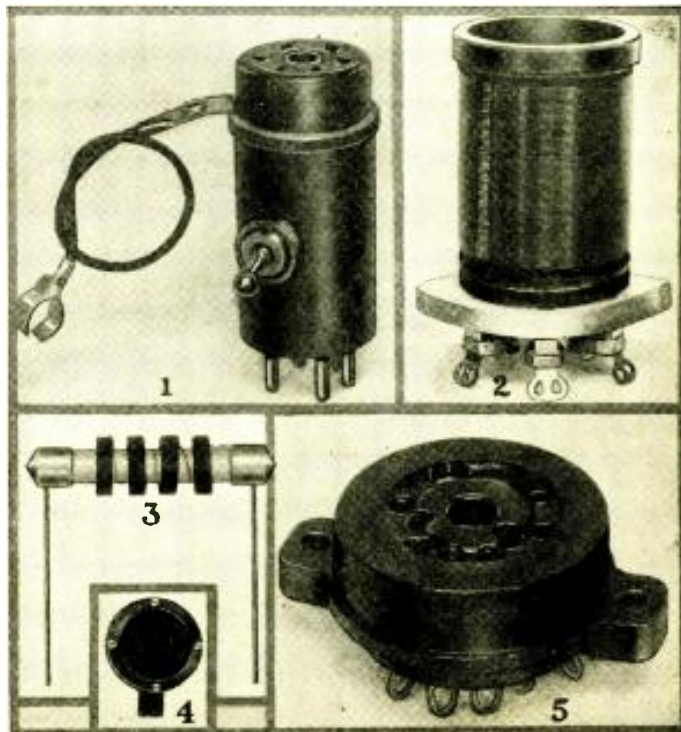

Fig. 4, right
An entire line of brand new items for the Service Man or experimenter. Plugs, coils, special S. W. chokes and microphones are offered.

NOISELESS ANTENNA SYSTEM

FIGURE 5 is a device that Service Men have waited for with some impatience. It is a device that, when connected to a shielded lead-in, reduces the noise picked up by the antenna system. How?



Fig. 5. Photograph of the Pacent Radioformer.

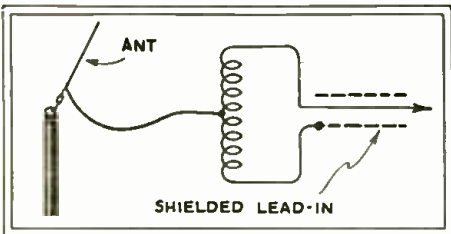

Fig. 6. Suggested schematic circuit of the Radioformer.

Well, it is a known fact that the lead-in picks up the greater part of the energy called noise. This may be obviated by shielding the lead-in. To reduce capacity effects, the Radioformer, a product of the Pacent Electric Co., is interposed as shown in Fig. 6.

A CODE TEACHER

THE device illustrated in Fig. 7 was designed for the man who wants to be "tailor made." It is a self-teaching code practice set. An audio oscillator has its output varied by the practice key, which results in a record being made on a tape which may be played back in the same machine, and heard. A product of Teleplex.

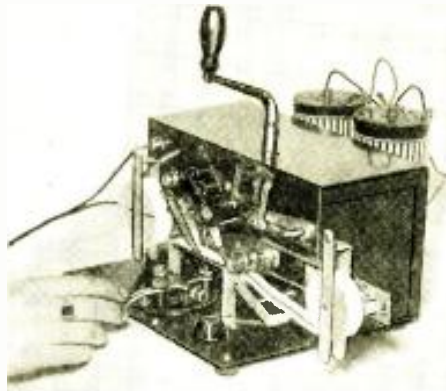

Fig. 7. The Teleplex code practice set.

THE SYNCROFILM PROJECTOR

A PORTABLE sound projector, weighing but 60 pounds, has recently been developed by the engineering staff of the Weber Machine Co., and is pictured in Fig. 8. It is complete in every detail, and is equipped with amplifier, speaker, sound head, etc. The beauty of the device is that it may be set up in almost any location demanded by circumstances.

THE WONDER "BAR" RECEIVER

THE very unique radio set pictured in Fig. 9 was designed to serve a double purpose—a radio set and dispensing bar. When closed, it appears as shown to the left, and when opened, it appears as shown to the right. When in this latter position, the "dispensing" part is ready for action.

The receiver is made in several types: The first, known as the 51, is a combination bar and radio operating from 110 volts A.C., and covers the range from 150 to 550 meters; the model 46 operates from D.C., covers the same range, and uses the type 14 tubes in the R.F. end of the set. They are products of the Wonder Bar Radio Corp.

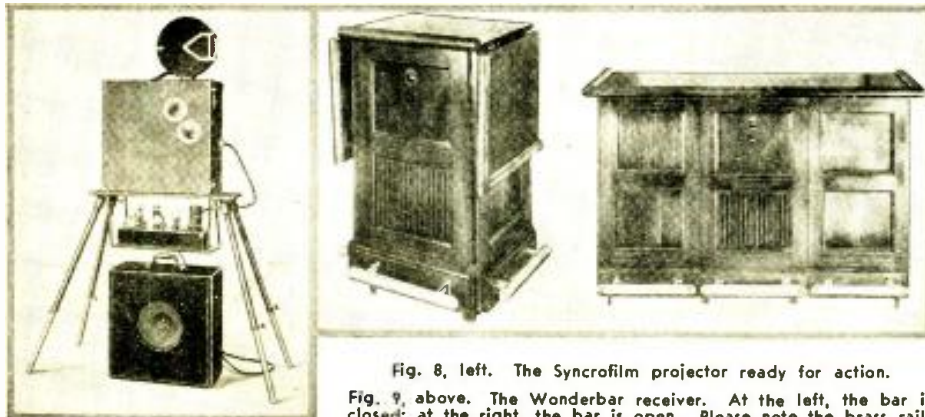

Fig. 8, left. The Syncrofilm projector ready for action. Fig. 9, above. The Wonderbar receiver. At the left, the bar is closed; at the right, the bar is open. Please note the brass rail!

A REMOTE-CONTROL TUNING UNIT

REMOTE-CONTROL tuning has long since passed the luxury stage. In fact, in many installations, Service Men have found them absolutely necessary in order to effect a good installation. Fig. 10 is an example of such a unit, designed for installation by Service Men, which may well be incorporated in the kit of tools. It is a product of the Federal Telegraph Co.

Appended here are some of the features of the control device: Operates through one standard cable length, 25 feet long; operates independently of the set; turns the set on and off; controls volume; easy to install; has no electrical contacts; has no motor; and no complications at all.

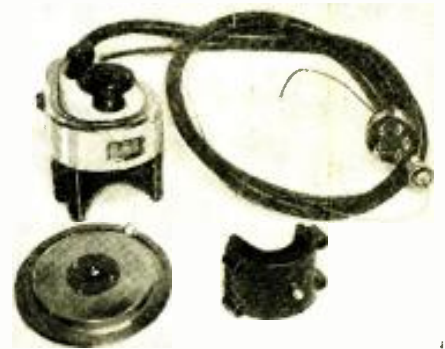

Fig. 10. The Federal, remote-control tuning unit.

A DIRECT-READING OHMMETER

THE new point-to-point method of measuring resistance has created quite a demand for portable ohmmeters. The instrument illustrated in Fig. 11, manufactured by the Westinghouse Electric and Manufacturing Co., has just been announced. It is equipped with resistance ranges of 5,000 and 50,000 ohms, and operates directly from a single dry cell. The current consumption is so small that the life of the battery is said to equal its "shelf life."



Fig. 11. The Westinghouse ohmmeter. The toggle switch selects the proper range.

NEW TUBE ANNOUNCEMENTS

This month's allotment of tubes is varied. First, we have a power-output pentode for D.C. operated receivers; then a W.E. tube for amplifier work; a new power amplifier and modulator; and finally, an output pentode for standard, 2.5-volt use.

LOUIS MARTIN

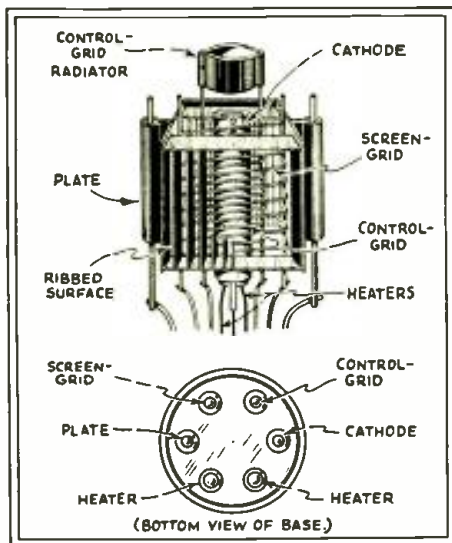

Fig. 1, above
Details of the internal construction of the 48.
Fig. 2, lower
Tube pin connections of the 48—a bottom view.

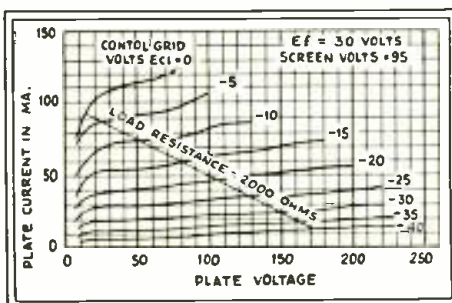

Fig. 3
Plate-voltage—plate-current curves of the 48 with various grid biases. Note the load line of 2,000 ohms.

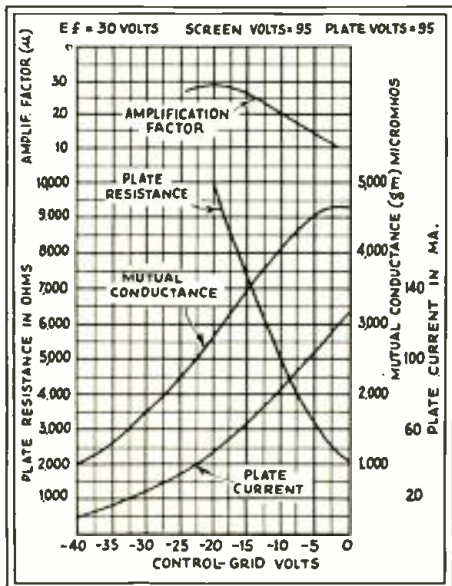

Fig. 4
Dynamic characteristics of the 48.

IT HAS been the general contention of engineers and Service Men for many years past that D.C. power-operated receivers could never produce the same undistorted output as the standard A.C. operated receiver. This has been true for many years, but since the recent numerous additions to the tube line include tubes especially designed for D.C. operation, the above statement no longer holds.

The 48, Power Output Tube

The most recent tube announced at this writing is the 48, pictorially shown in Fig. A. The dome-shaped envelope is more or less familiar to us since the arrival of the 58, but, in this instance, it serves another function. As illustrated in the photograph, at the top of the tube a large star-shaped mica disc separates a cylindrical plate at the extreme top from the remainder of the

surface. The ribbed structure serves to suppress the secondary emission which limits the power output of the usual four-element tubes. It might be well to add that the large amount of heat dissipated in the cathode also, of course, heats the control grid and means must be taken to cool this grid. Hence the aforementioned structure in the dome of the tube which is nothing but a heat radiator for the grid.

The heater of the 48 is designed for series operation at 30 volts, therefore permitting the design of a circuit using two of these tubes in series which will require a minimum of auxiliary resistance in the heater circuit with a consequent reduction of heat energy to be dissipated in the receiver.

The base pins of the 48 fit the standard six-contact socket which may be installed in either a vertical or horizontal position. A schematic circuit

48

A power-output pentode. Filament voltage, 30; filament current, .3-amp.; power output, 2.5 watts; plate voltage, 100; screen voltage, 95; plate current, 50 ma.; screen current, 10 ma.; grid bias, 21 volts.

262A

An amplifier triode. Filament voltage, 10; plate voltage, 180; grid bias, 7.5 volts; filament current, .3-amp.; plate current, 3 ma.; plate resistance, 16,000 ohms.

elements. The edges of this disc are tightly pressed against the dome shaped top for support. A diagram illustrating the internal construction of the tube is shown in Fig. 1.

This 48 may be described as a power amplifier tetrode having pentode characteristics at the recommended screen and plate voltages, for use in supplying exceedingly large power outputs from receivers designed for operation on a 115-volt, D.C. power line. The main feature of this type of tube is its ability to deliver power at the low plate and screen voltages obtainable from such service. In fact, two type 48 tubes in a push-pull circuit are capable of delivering an output equivalent to 16 type '38 tubes!

The large power-delivering ability of the 48 is made practical by the unique features of its electrical and constructional design. Among these are the big cathode with its large emitting surface; the control grid structure with its heating radiator (which is the small cylindrical plate at the very top of the tube); and the plate, which has a ribbed structure fastened to its inner

showing the design of the base of the tube is illustrated in Fig. 2. This view shows the base of the tube looking up. It might be well to mention at this point that although the heater of this tube is designed for 30-volt operation, it is possible to operate a receiver using these tubes in a location where the line voltage fluctuates so that the voltage at each 48 may vary from 26 to 34 volts.

In a series heater circuit employing several 6.3-volt tubes and one or more 48's, the heaters of the 48's should be placed on the *positive* side of the line potential.

As a class A amplifier, the 48 is recommended for use either singularly or in push-pull in the power-output stage of D.C. receivers. If a single 48 is operated self-biased, the self-biasing resistor should be 360 ohms. This resistor should be shunted by a suitable filter network to avoid degeneration effects at low, audio frequencies. The use of two 48's in push-pull, of course, eliminates the use of shunting the resistor. The self-biasing resistor required for the push-pull stage is ap-

WHERE TO USE THE NEW TUBES

The 48 is a power-output pentode for use in D.C. operated receivers. It has a 30-volt filament and is designed to operate in series with the usual 6.3-volt automobile tubes. It has an output equal to 8 type '38 tubes.

The 262A is a Western Electric three-element amplifier tube designed for use in audio amplifier circuits. It is rugged and non-microphonic.

The 842 is an amplifier-modulator tube suitable for transmitting purposes, or in high-powered audio amplifier systems.

The 59 is a 2.5-volt power-output pentode for A.C. operated receivers. Three separate grid connections are brought out to facilitate its use as a class A triode, a class A pentode, or as a class B triode.



The figure numbers from left to right are A, B, C, and D. Fig. A is the 48, D.C. operated output pentode; Fig. B is the new W.E. amplifier tube; Fig. C, the amplifier-modulator tube; and Fig. D, the 59, A.C. operated output pentode.

(Photographs courtesy R.C.A. Radiotron, Western Electric, and National Union.)

proximately 180 ohms.

Any conventional type of input coupling may be used provided the resistance added to the grid circuit by this device is not too high. This is in direct contrast to the usual arrangement where high input impedances are demanded, except in class B tubes. In any case, the sum of the resistance of the coupling device in the grid circuit and the resistance of the filter network (if used) should not exceed 10,000 ohms.

Figure 3 shows the relation between plate current and plate voltage at various grid potentials. Note particularly the absence of the "hump" at low plate voltages which is so predominant in the ordinary four-element tubes. Figure 4 shows a set of curves of the variation of its dynamic characteristics. A receiver using this tube is described elsewhere in this issue and the writer

manufactured either by the Western Electric Company or by the American Telephone and Telegraph Company, but may be secured by any person licensed by the Federal Government to operate an amateur radio telephone station.

The following ratings and characteristics of this tube, illustrated in Fig. B, obtain: Heater voltage, 10 volts A.C. or D.C.; heater current, .29- to .35-amp.; maximum plate voltage, 180 volts; grid bias, -7.5 volts; average plate current, 3 ma.; amplification factor, 15; plate resistance, 16,000 ohms. The low interelectrode capacitances listed below should make this tube suitable for short-wave work: Plate to grid, 1.9 mmf.; plate to cathode, 4.0 mmf.; grid to cathode, 1.8 mmf.

The 842 Power Amplifier and Modulator

The 842 is a three electrode, low-mu,

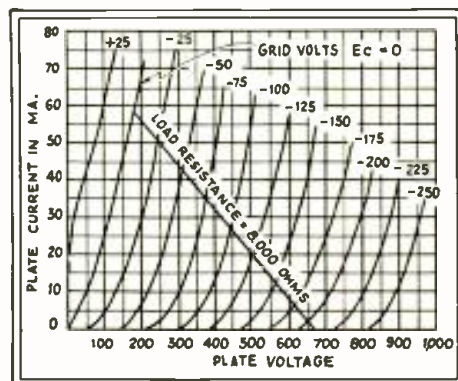

Fig. 5

Plate-voltage-plate-current curves of the 842, amplifier or modulator tube.

842

Amplifier-modulator. Filament voltage, 7.5; plate voltage, 400; grid bias, 80 volts; plate current, 30 ma.; undistorted power output, 3 watts; permissible grid swing, 80 volts.

59

A power-output tube. Has individual grid connections. Filament voltage, 2.5; filament current, 2 amp. The ratings of this tube vary, depending upon the mode of connection; see text for detail ratings.

wishes to state that it is only by hearing a receiver using 48's that one may appreciate the tremendous gain over its predecessors.

The following ratings and characteristics obtain: Heater voltage (D.C.), 30 volts; heater current, 0.4-amp.; plate voltage, 95 to 125 volts; screen voltage, 95 to 100 volts; grid bias, -20 to -22.5 volts; plate current, 47 to 50 ma.; screen current, 9 ma.; plate resistance, 10,000 ohms; amplification factor, 28; mutual conductance, 2,800 micromhos; load resistance, 2,000 ohms; power output (9% total harmonic distortion), 1.6 to 2.5 watts.

The Western Electric 262A

Of special importance at this time is the announcement of the characteristics of the Western Electric 262A vacuum tube—a three-element tube having an indirectly heated cathode which permits operation of the heater element directly on A.C.

It might be well to state that this tube cannot be purchased by the ordinary broadcast listener or Service Man. It is designed for use in equipment

high vacuum tube designed primarily for use as a class A power amplifier, and as such is particularly useful as a modulator tube in amateur transmitting equipment. In general appearance and filament characteristics this tube resembles the '10, as shown photographically in Fig. C. There are very few unusual features about this tube, but there are several points which should be given detailed consideration.

The grid return as well as the plate return circuits should be connected to the mid-point of a resistor placed across the filament winding of a transformer. If operated from D.C., these returns should be connected to the negative filament terminal. In cases where the 842 is employed in resistance-coupled circuits, the recommended safe maximum value of grid leak is 1. megohm if the self-bias method of obtaining grid voltage is used. Values higher than this may so aggravate any slight trace of gas or electrical leakage existing in the grid filament circuit as to start a small grid current with the result that a voltage drop opposed to

(Continued on page 367)

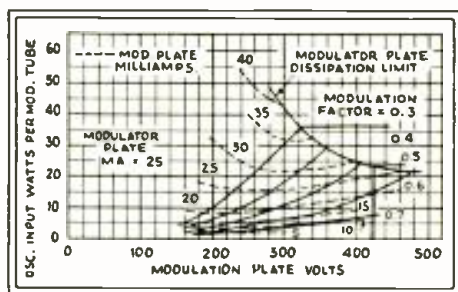

Fig. 6

Curve showing the relation between required oscillator input watts and required modulator plate voltage for the modulation percentages (indicated by the solid lines) and plate currents (indicated by the dotted lines) shown.

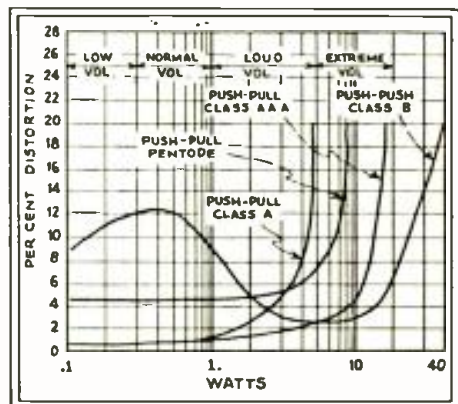
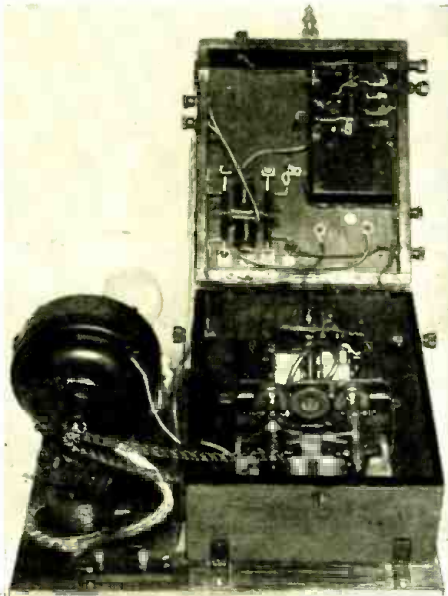

Fig. 7

Three excellent curves showing the relation between distortion and output power for the 59 connected either as a push-pull pentode, a push-pull class A stage, or as a push-pull class B stage.

BUILDING A REMOTE-CONTROL TUNING SYSTEM

C. H. WEST



View of the completed apparatus showing the layout of all parts.

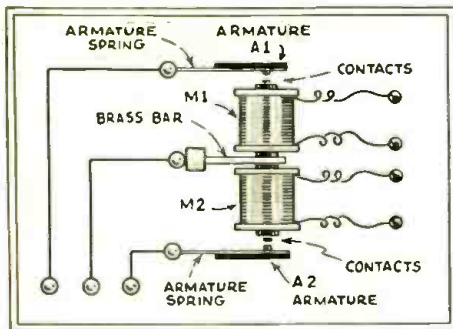

Fig. 1 Schematic of the circuit breaker.

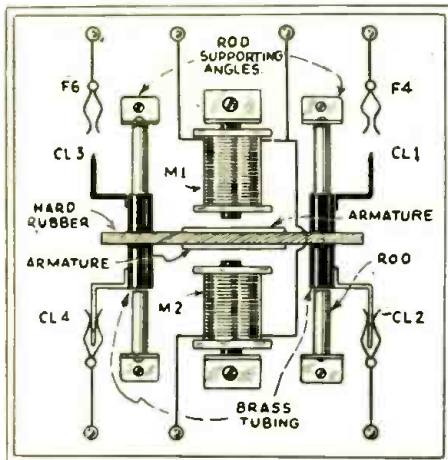

Fig. 2 Diagram showing the connection of the motor and filament-cut-off relay.

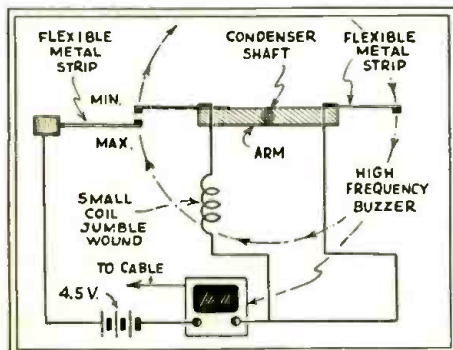

Fig. 5 The method of connecting the buzzers to indicate when the tuning condenser has reached the extremities of its range.

A CASUAL glance at the accompanying photographs and schematic diagrams will impress the layman and reader that what follows represents a highly complicated system, and involves too much work. This is not the case. Most of the equipment may be found around any amateur workshop, and consists of a few old buzzer magnets, worm and worm wheels, and a driving motor.

Remote control transmitters are considered the *desideratum* of a good station; but our opinion is that the operator should be where the transmitter is; while the receiver should be located at almost

any distance ranging from feet to miles. With this idea in view, this remote control unit was conceived, put into practice, and found ideal for either amateur or professional use. With a few slight modifications, it is adaptable to the broadcast receiver.

Suppose we examine the fine points of this apparatus without going into the details of construction. We find—that by pressing buttons No. 1 and No. 2 together, the filaments of the receiver are active, and the driving motor becomes activated while idling. We press on button No. 1 and the variable tuning condenser starts to rotate slowly from the minimum towards the maximum capacity.

We hear a station and let up on the button. The station stays there. Again we press on the same button and tune in another station—and so on.

Now, we press on button No. 2. The tuning condenser reverses

its action from maximum to minimum, and we are able to come back to any previous station just heard. However, the volume or regeneration does not seem to be quite right or of sufficient strength. We press on button No. 3 in form of a "dot." This steps up a very small degree of regeneration, and if it is not sufficient, we follow up with as many "dots" as necessary (which are not many).

We wish to discontinue operation of the receiver. Simply press on buttons Nos. 2 and 3. The filaments are extinguished, and the motor stops. We now examine our operating table and simply find three small push buttons. Even the telephone receivers are with us. There is a small remote control indicator in front showing the degree or any caption representing volume or regeneration. There is still another indicator, which tells us when we are at the minimum or maximum range of the tuning condenser; and all remote control.

Then we examine the cable which leads from the receiver to our table. Our surprise is still greater. We find just four wires. How can a receiver operate at a great distance with so few, when indicators, tuning, volume, phones, "B" power, cut-offs and ons—are all located somewhere within the tangled mess. We are very much interested and grab the main diagram of the "works"; and after tracing out a few leads, exclaim: "How simple!"

FEATURES OF THIS REMOTE TUNING DEVICE

Electrically operated; uses dry cells; employs ordinary household bells and buzzers for the relays; may easily be constructed at home without any intricate machine-shop equipment.

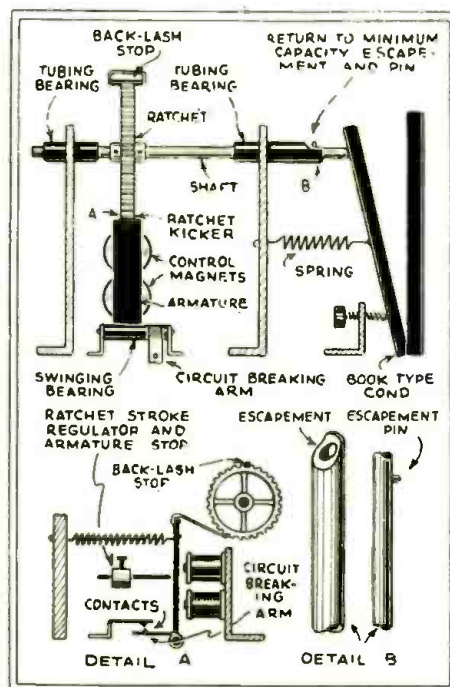
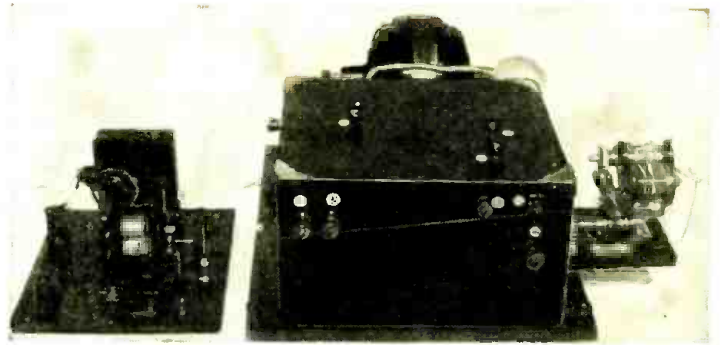

Fig. 4 Diagram of the arrangement of the regeneration or volume-control unit.

Complete constructional data of a new remote-control tuning system that may easily be built at home by any amateur. It tunes, controls volume, and shuts the set "on" and "off."



View of the completed equipment with the cover closed.

Therefore, leaving out the fine points and reserving same to illustrate the text and constructional data, we will take up the first step in construction, which deals with the "Circuit Breakers" and "Relay"—although the simplest are most important.

Circuit Breaker Unit No. 1

This circuit breaker consists of two electromagnets of the bell or buzzer type. They are rewound with the same number of turns of No. 20 D.C.C. wire. The metallic core should be well insulated to prevent a short circuit between the windings and the core. In the center of each core a small hole is drilled and a contact point of silver or iridium installed. The two magnets should not be fastened together by their riveted ends, but to a strip of heavy brass. The charging of one magnet should not affect the other. The armatures should be of flimsy material; the soft iron cores of old audio-frequency

WHAT THIS DEVICE DOES

From any remote point which is connected to the radio set by a 4-wire cable, this tuning device does the following: (1) Turns the radio set "on" or shuts it "off"; (2) Raises or lowers the volume at will; (3) Tunes the radio set to any desired point.

transformers are very suitable. Each armature should have fastened to it a thin strip of spring brass. The object of this is to operate the armature with the least amount of pull; as each one of these electromagnets are in series with the main tuning-control magnet.

A contact point is located in the end of each armature, and adjusted just close enough so that exterior vibrations will not close the contact.

From an examination of Fig. 1, it can be seen that any power applied to "M1" will actuate armature A1, and the same applies to M2 and A2; and if power is applied to both magnets, both

A1 and A2 will close. The reason for the use of larger wire in these magnets is to reduce its resistance and not cut down the flow of current through them. This unit may be mounted on the same base with all other apparatus.

Motor and Filament Cut-off Relay
This relay, Fig. 2, consists of two
(Continued on page 362)

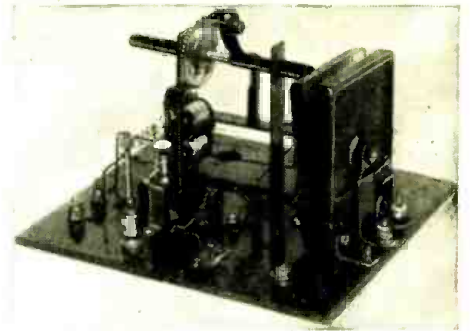

The volume-control unit. Detail drawings are given in Fig. 4.

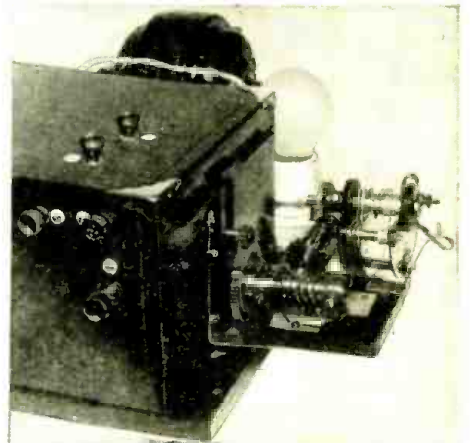

Close-up view of the volume-control condenser shown schematically in Fig. 4.

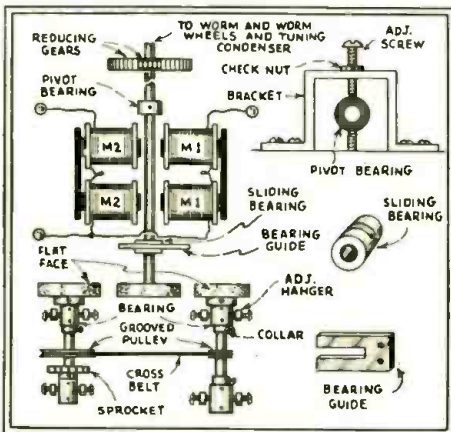

Fig. 3, above
Diagram showing the connections and mechanical arrangement of the tuning-control relays. When magnets M1 are excited, the shaft is pulled to the right, revolving the right-hand, flat-faced pulley.

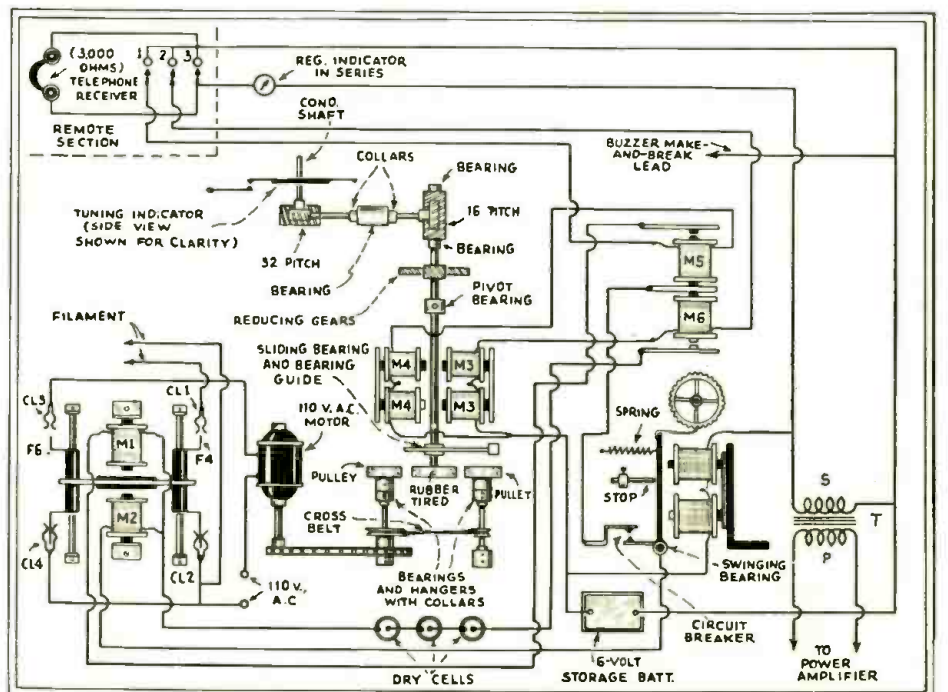

Fig. 6, right
Complete schematic circuit of the remote-control tuning unit. The three remote-control buttons are shown at the upper left; the four-wire cable to the unit itself connects to these buttons. The meter shown is not essential.

HOW TO BUILD THE SAVIL TYPE 748 D.C. KIT-SET

B. S. VILKOMERSON*

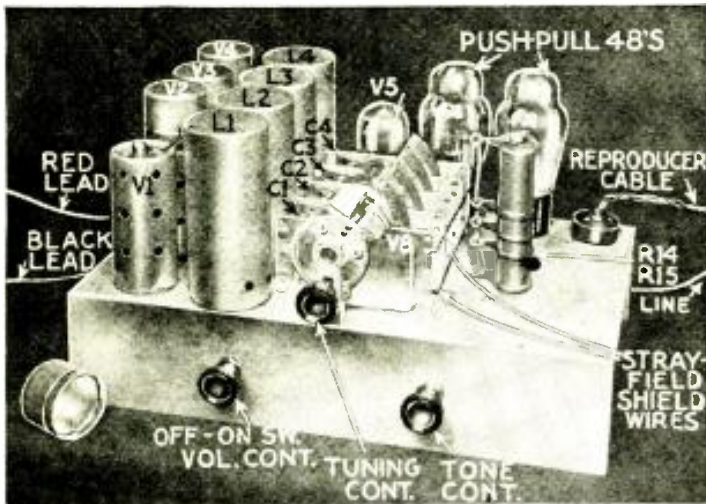

Fig. A
External view indicating the layout and stressing the important points of construction.

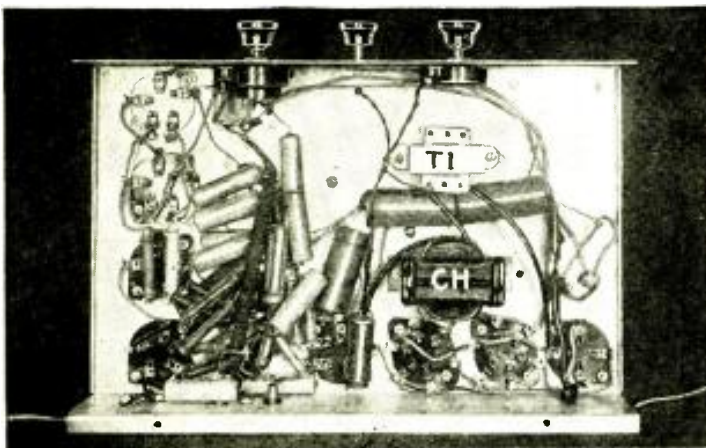

Fig. B
Under-chassis view. All small condensers and resistors are placed as close to their terminating points as possible.

WHY YOU SHOULD BUILD THIS RECEIVER

...Tests in our own laboratories convinced us that this set has as good quality as any A.C. operated receiver costing three times as much as the Savil receiver described here.

The parts for this receiver may be purchased, complete, for about \$20.00. All parts are standard, and may easily be obtained on the open market. With an antenna consisting only of the human body, local stations were brought in with tremendous volume; in fact they could be heard, easily, a block away! Although distant stations were brought in without any trouble at all, there was absolutely no interference from the locals mentioned above—and in the daytime, too!

Without any hesitation, we say this is one of the best D.C. operated receivers that has come to our attention.

TWO type "48" tubes equal 16 of the older, type '38 tubes! In this single sentence is contained the outstanding feature incorporated in the distinctly new receiver design illustrated in Fig. A; an underside view is Fig. B; in Fig. 1 is shown the schematic circuit.

The writer presents to the (hitherto unfortunate) residents of D. C. districts a direct-current set which gives results in all respects as good as those obtainable from an A.C. receiver. The "brand new" type 48 tube has now made it possible for the radio receiver manufacturer to make a moderately-priced set operating from the D.C. line which compares very favorably in A.F. output with the standard A.C. sets. The power output of two or three tubes in push-pull is 5 watts!

Some idea of the power output at 100 V., plate, may be secured by considering that it would require more than 16 of the older, type '38 pentodes to equal the performance obtainable from two, type 48's, as illustrated pictorially in Fig. C.

The Savil Type 748 D.C. Kit-Set was

*In charge of engineering, Savil Radio Engineering Corp.

designed to secure the advantages of the type 48 tube, by arranging the circuits to fit its special characteristics.

Perhaps the best way to describe the 48 tube is to compare its characteristics with those of the better known '47. Both are A.F. power tubes of equal output; but whereas a single '47 gives 2.5 watts output with 250 V. on the screen-grid and plate, a single 48 gives 2.5 watts with 100 V. on the screen-grid and only 125 V. on the plate. The '47 is a pentode, the five elements being the filament-type cathode, control-grid, screen-grid, suppressor-grid, and plate; these connect to a 5-prong base. The 48 is a tetrode, with heater-type cathode, control-grid, screen-grid, and plate; these terminate at a 6-prong base. The function of the suppressor-grid in the '47 is performed in the 48 by a special rib structure welded to the inner surface of the plate. The cathode has an unusually large emitting surface, the heater taking .4-amp. at 30 V.; (12 watts power consumption for the heater of the 48 as compared to 4.5 watts for the filament of the '47).

This high heater voltage is helpful on D.C. sets, as it makes a minimum of additional resistance necessary in the

series filament circuit. This advantage is clearly indicated in Fig. 2, which shows the voltage drop across each filament in the series; the "bleed" current is put to use in the field coil. Resistor R15 and pilot light V8 pass the added current required by the push-pull 48's.

Other characteristics of the 48 which influence set design are its lower amplification factor ($\mu 28$) as compared to that of the '47 ($\mu 150$), and the makers' specification of a maximum of 10,000 ohms resistance in the external part of the control-grid circuit. This limits the types of input devices which may be used to either transformer or impedance coupled units. These factors, in turn, make it preferable to use a triode as the tube preceding the 48.

A description of the audio end alone would suffice to give the necessary information regarding the use of the 48, and it actually is only the correct use of the 48 which gives this receiver its exceptionally good volume and tonal quality. When the writer found how well the output from the audio system compared with that obtainable from good A.C. sets, he decided to go the rest of the way and use an R.F.

end which would give the additional selectivity and sensitivity warranted by the greatly improved audio system.

As can be seen from the diagram, a four-gang condenser is used, the first three tuned circuits being the inputs of three type '39 multi-mu R.F. pentodes, while the fourth is coupled to the control-grid of a type '36 screen-grid detector. With properly designed coils, this R.F. arrangement will give adequate selectivity and far more than enough sensitivity to go right down to the noise level in even the best locations.

It need hardly be mentioned that D.C. locations are usually much worse than A.C. for noise (due to the sparking of commutator equipment), so that the maximum useful sensitivity is usually quite limited. Some radio men still have the notion that "a sensitive set brings in too much noise" in a noisy location. This is true only to the extent that a more sensitive set can bring in more noise in a noisy location; but in comparing a set having a high maximum degree of sensitivity with a less sensitive set, at any location, it will always be found that any station that can be tuned in on the less sensitive set can be brought in on the more sensitive set at exactly the same volume with neither more nor less noise, the audio frequency response range of the two sets being equal. (Of course, a set that "loses" low notes and high notes also "loses" some static.) On the other hand, wherever and whenever noise conditions are not particularly bad, the more sensitive set will bring in more stations.

Again, in many D.C. locations the installation of an adequate antenna system is impossible, in addition to the field strength of the broadcasting stations being low on account of the shielding effect of intervening steel structures. In such cases, a very sensitive set used with a short piece of wire hung outside the steel building will often give surprisingly good results, since the steel structure of the building acts as a grounded shield to keep the electrical noises generated by de-



Fig. C

2 TUBES REPLACE 16!

The enormous power output of this receiver is due, in part, to the use of the new type 48 tubes, described elsewhere in this issue. This is illustrated above; the two 48's are shown above the 16 type '38 tubes—the undistorted output of both groups being the same!

Those in D.C. districts have no need to anathematize the scratchy output of D.C. receivers—not with these tubes. In fact, the amplification is so great in the audio amplifier that a phonograph may easily be connected to the terminals provided to secure clear, undistorted reproduction.

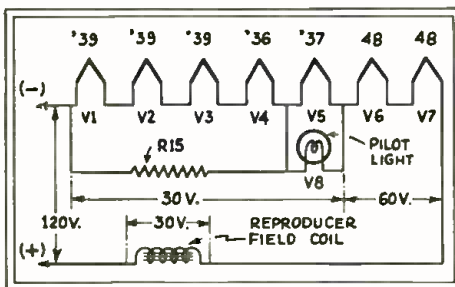

Fig. 2
Circuit illustrating the wiring of the filaments.

vices inside the building from affecting the aerial wire outside! Of course, any lead-in wiring inside the building picks up noise, and therefore should be kept down to a minimum length. However, the real job will incorporate one of the modern R.F. coupling systems.

It will be noticed from the diagram that some manufacturing economies in R.F. bypassing are affected by using cathode, screen-grid and plate voltage supplies common to two adjacent R.F. stages. Since any R.F. voltages across these bypass condensers are of opposite phase, any common coupling is of a degenerative nature, thereby giving added stability. The third R.F. stage, whose R.F. currents would be in phase with those of the first stage, has decoupling resistors in the voltage supply lines, and separate bypass condensers to the ground point.

Another innovation is the use of a dry, non-polarized electrolytic condenser in the D.C. filter system! (both electrodes are formed). The usual polarized electrolytic condenser would be destroyed if the line plug were inserted the wrong way. A paper condenser of equal capacity would be much bulkier and cost several times as much as the non-polarized electrolytic unit, which gives equally good results.

An idea of what degree of selectivity may be expected from this set may be had from the fact that in down-town Manhattan it was found possible to bring in WJR (Detroit) operating on 750 kc. and WBBM (Chicago) operating on 770 kc. with little or no interference from the local station WJZ operating on 760 kc.

This degree of selectivity is due in no small measure to the design of the R.F. transformers. The primary of L1 has 8 1/2 T. of No. 26 S.C.C. wire, spaced two turns, and wound over the filament end of the secondary; the primaries of L2, L3, L4 consist of 50 T. No. 32 S.S.C., solid wound over the filament end of the respective secondaries. Each primary is spaced from its secondary by three layers of Empire cloth. Each secondary consists of 127 T. No. 32

(Continued on page 366)

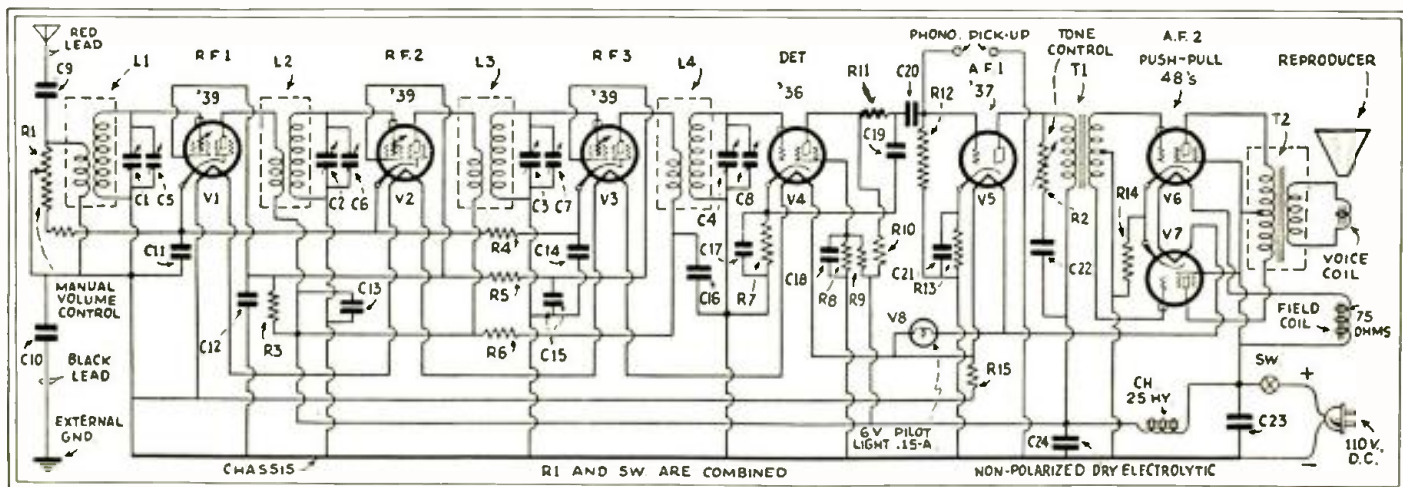

Fig. 1

Schematic circuit of the receiver. Variable-mu tubes, push-pull 48's, tone control, terminals for phonograph pickup, and non polarized electrolytic condensers are some of the features of the receiver.

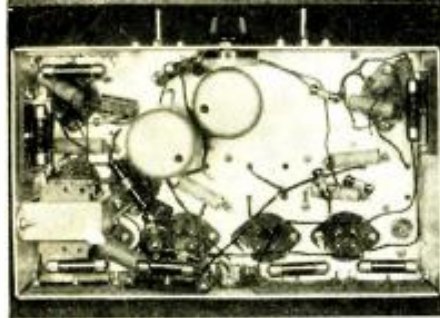

Fig. A above
An external view of the 2-volt receiver described by the author.

Fig. B below
An under-chassis view showing the layout of the parts.

CONSTRUCTING A 2-VOLT SUPERHETERODYNE

A description of a 2-volt receiver of the superheterodyne type capable of excellent quality, volume, and distance.

H. G. CISIN, M. E.

FEATURES OF THIS RECEIVER

Uses push-pull output; hence has excellent quality and volume.

Variable- μ tubes minimize interference.

Being a superheterodyne, it is extremely sensitive.

Operates entirely from batteries, and therefore may be made portable.

Economical in operation.

Low cost of construction.

Ease of operation.

bias of the two I. F. tubes, as shown.

The second detector V5 is of the power type. Its D.C. grid bias is obtained from the same source as the I. F. amplifier. However, its R. F. path is carefully isolated from the I. F. stages. The two-stage audio amplifier is of standard design. With the two type '33 pentode tubes in push-pull, the power output is slightly more than 1.2 watts. A magnetic speaker designed for use with these pentodes will give best results.

Individual amperites are used to reduce the voltage of a standard storage battery to the correct value for the 2-volt tubes. These resistors also improve operation by preventing voltage fluctuation, and furthermore, they act as fuses, thus preventing injury to the tubes through over-voltage. For complete protection to the tubes, Instrument Littel fuses should be incorporated in the "B" supply line.

The chassis material is drilled for all socket holes, including the one at the rear for the cable connection. It is then bent to the size specified at A in the schematic circuit, Fig. 1, and the sockets mounted. The two variable condensers are mounted as indicated in Fig. A. Next, the three I. F. transformers are fastened in place and finally the two binding posts.

The chassis is then turned upside down and the volume control 26 is (Continued on page 367)

THE 2-volt superheterodyne illustrated in Figs. A and B is an up-to-date battery receiver incorporating 2-V-filament tubes in a carefully designed, modern circuit, Fig. 1. This receiver is highly suitable for use in the home, especially where house-lighting current is not available. In such cases, the filament current may be supplied by dry cells or a storage battery.

The 2-Volt Superheterodyne also makes an excellent portable, since it is light, compact, and powerful and has a high degree of sensitivity; install the batteries and speaker in a separate carrying case. The total filament drain is 880 ma.

The first detector, V1, uses grid-circuit rectification thus insuring maximum sensitivity. The oscillator, V2,

is coupled to the detector stage capacitatively by means of condenser 7. Great care has been used in the design of the I. F. stages which are to be peaked at 465 kc. The selection of this high I. F. is desirable since this means a high oscillator frequency and hence fewer harmonics within the receiving range. This in turn results in a closer approach to the desired "one-spot" tuning. The type '34 variable- μ tubes used as V3 and V4 help to improve the characteristics of the I. F. amplifier. Since there are two I. F. stages with tuned grid and plate circuits, adjacent channel selectivity is sharp and clean-cut. The grid-return circuits of the two I. F. stages are carefully isolated thus preventing any tendency towards instability. Volume control is attained by varying the grid

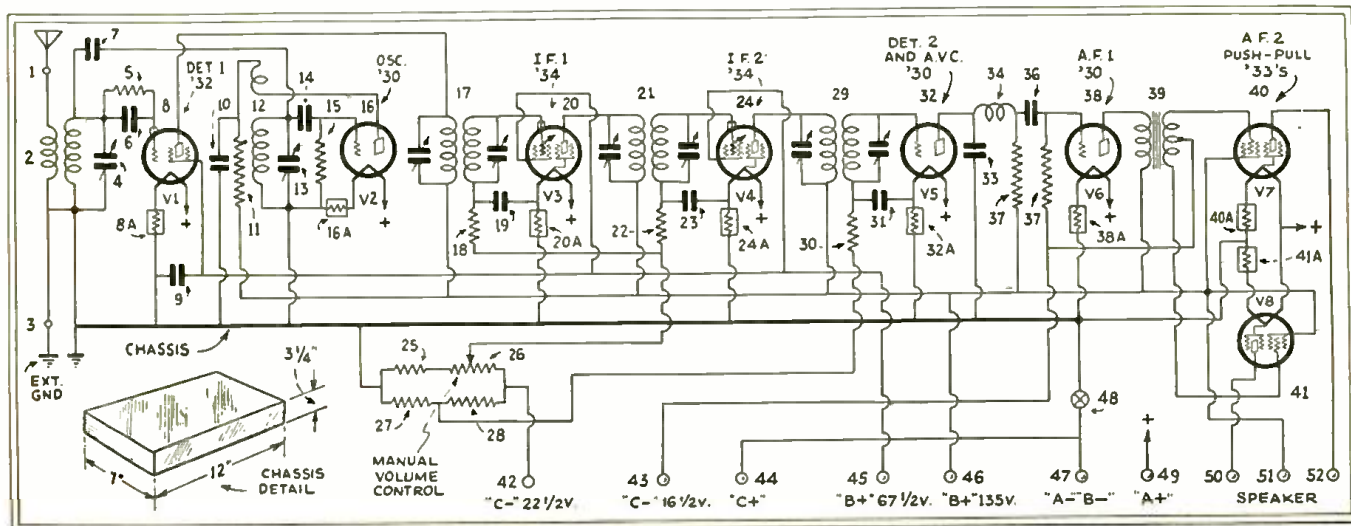

Fig. 1

Complete schematic of the receiver. Complete isolation of the grid circuits is afforded by the resistors in the grid-return circuits.

BUILDING A DIRECT-READING MUTUAL CONDUCTANCE METER

J. H. POTTS

An article describing the method of constructing a tube tester that reads the actual mutual conductance directly



Fig. A
Panel view of the versatile, direct-reading, mutual conductance meter designed by Mr. Potts

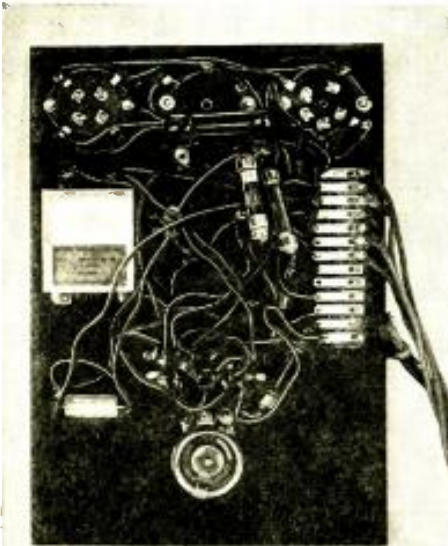

Fig. B
Under-Chassis view. The layout is self-evident

IT IS the purpose of this article to describe the design and construction of a small, inexpensive tube tester which will read directly the mutual conductance, in micromhos, of amplifying tubes of all types. It employs a new principle which makes its operations simple, yet precise. No mental arithmetic or "balancing out" operations are required. The apparatus is easy to make, and is adaptable to laboratory, shop or field service work.

It is possible to measure the mutual conductance of a tube in a particular set and under the operating voltages with which it will be used. Dealers and jobbers will find it indispensable for checking the uniformity of new tubes as its accuracy is such that it will discriminate between good and better tubes. Since the apparatus cannot be damaged by defective tubes, a separate set for shorted elements is unnecessary. In the field, the Service Man can make rapid tests of tubes in an operating set with a precision heretofore impossible with the usual type of analyzer, eliminating a large element of guess-work.

Analyzers are usually fitted with a 4½-volt battery for tube testing. The

plate current is read first with normal grid bias, then a second reading is taken with the grid voltage shifted 4½ volts positive from the initial bias. The difference in the two readings is an indication of the tube's mutual conductance. However, tubes of widely differing plate currents may have the same mutual conductance; and with power tubes, with the meter shunted for the heavy plate current, it is difficult to determine how much change in reading takes place from the 4½-volt grid shift. Also, when there is a high resistance in the plate circuit the increased voltage drops due to the increase in plate current resulting from the grid shift voltage, makes any intelligent estimate of the tube's condition almost impossible. Since even under the best circumstances the grid shift system involves mental arithmetic, the testing is slowed up considerably.

Fundamental Circuit

The fundamental circuit used in this mutual conductance meter illustrated in Figs. A and B, is shown in Fig. 1. Normal D. C. voltages are applied to all tube elements, but instead of using D. C. to shift the grid voltage, a small

(Continued on page 369)

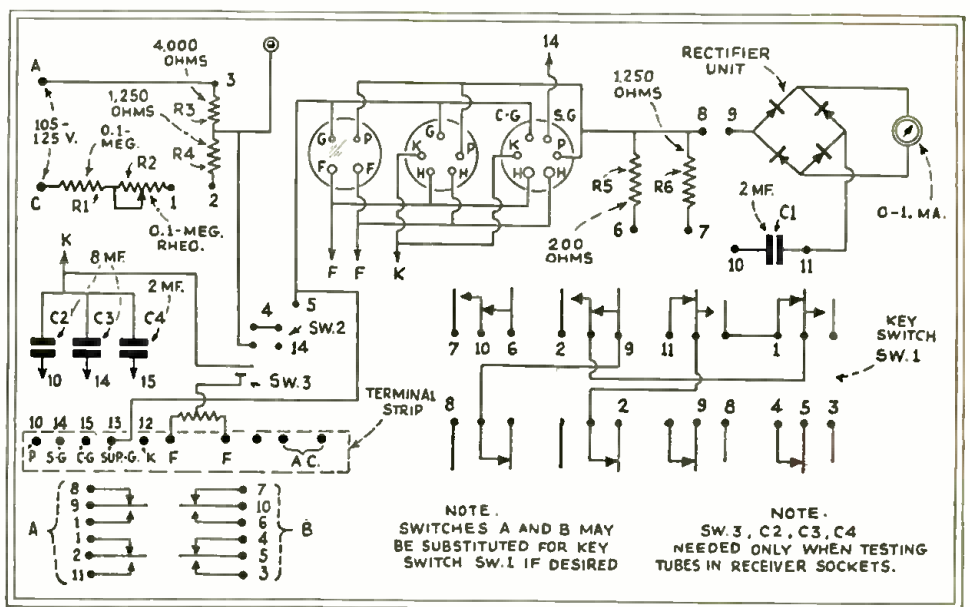
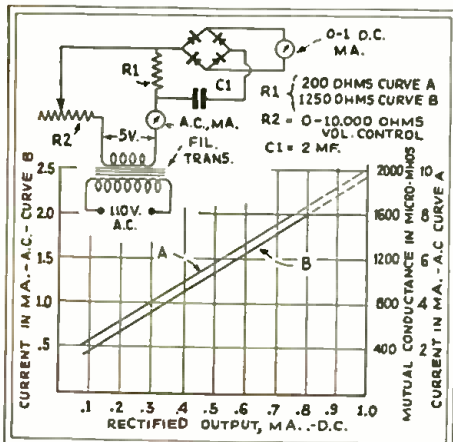
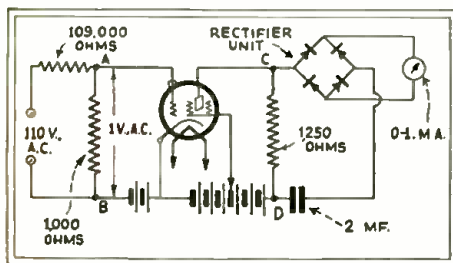

Fig. 1, upper left. Fundamental circuit of the tester.

Fig. 2, above. Circuit diagram of the tester. Note that the terminals of the switches are numbered. Connect all points having the same number together. The terminal strip connects to a cable plug.

Fig. 3, left... Calibration curves of the tester for two values of load resistance.

SOME INTERESTING LOUDSPEAKER FACTS

This second of a series of articles tells exactly what the baffle situation is regarding loudspeakers

PART II

ELI M. LURIE, B. E. E.

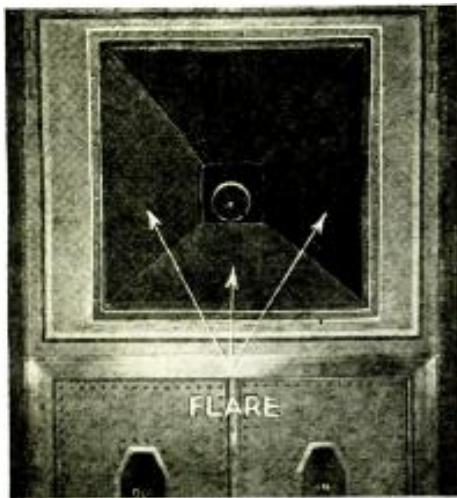

An example of the manner in which a flare is used on a loudspeaker. Note the depth of the horn. (Courtesy, Hotel New Yorker)

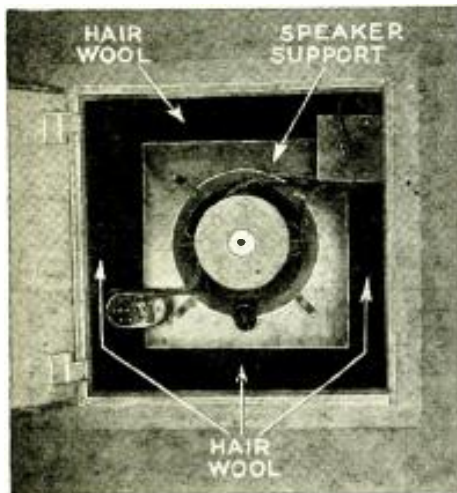

This speaker is set in a box lined with hair wool to prevent sound from coming from the rear of the speaker. (Courtesy, Hotel New Yorker)

CORRECT methods of baffling are undoubtedly the greatest hindrance to the majority of radio Service Men who would endeavor to produce an excellent sounding, public address system. It was shown in the preceding article that the formula for an effective baffle is

$$\text{Eff. Baffle} = \frac{\text{Wavelength of sound in inches}}{4}$$

In the past, this formula has been used as an absolute criterion for every kind and shape of baffle. It was the last word so far as most loudspeaker installations were concerned. However, the truth of the matter is that the formula is only applicable for *flat baffling* and should not be taken as final where used with any other type of baffling arrangement.

In the July, 1931, issue of the PROCEEDINGS of the INSTITUTE of RADIO ENGINEERS, Benjamin Olney, well known loudspeaker authority, definitely showed that, as the size of the front of a radio cabinet was decreased, the low-frequency response also decreased.

This immediately would indicate that if a flat baffle of any size is broken up and distributed so that it takes the form of a box, or cabinet, then the low frequencies will depend almost directly on the size of the front panel; and, as this last item is decreased in size, with a corresponding increase in the length of the cabinet sides, then the cavity resonance will increase and will almost be proportional to added increase of the sides. This condition can be illustrated by referring to Fig. 1A, which was taken from Mr. Olney's aforementioned paper.

However, this does not mean that the formula is worthless and is not one to

be used, for it can be applied with excellent results in places where flat baffling is used, and can be used for a rough check in almost all cases.

Suppose, for example, it is desired, in a certain building, to install a speaker such that with the given loudspeaker location to be somewhere on one of the end walls, and the height of these walls to be 20 feet, that all musical frequencies shall be reproduced, in their true fundamental tones, down to and including 50 cycles. Will the 20-foot wall be sufficient to reproduce down to 50 cycles? The room is 75 feet in length and 30-feet wide. Where on the 20-foot wall should the sound projector be located? Should it be nearer the top of the room, or should it be in the middle or near the bottom of the wall? What power level will be required to give good sound coverage and what kind and size of a power amplifier would you build to produce this level with a possible added safety factor of 50%? Why is it necessary to have an amplifier capable of delivering 50% more than the required room level? Also, what kind of a projector would you install?

Since the wall is flat, it would most certainly lend itself to baffle solution by means of the regular baffle formula. However, first it is necessary to change the frequency of the lowest desired fundamental to its wavelength in inches.

$$\text{Wavelength in inches} = \frac{1,100 \times 12}{50}$$

$$\text{Freq. in cycles per sec.} = \frac{1,100 \times 12}{264}$$

$$\text{and wavelength in inches} = \frac{1,100 \times 12}{50} = 264 \text{ inches}$$

Substituting this value in our regular baffle formula. . . .

$$\text{Eff. Baffle} = \frac{264}{4} = 66 \text{ in. or } 5' 6''.$$

This means that in order to reproduce 50 cycles, our baffle would have to measure 66 inches from the center of the cone, around the baffle to the center of the cone in the rear, or 33 inches on a radius around the center of the cone. Therefore our 20-foot wall would easily give us a fundamental of 50 cycles; in fact we could reproduce down to 13.6 cycles with such a baffle. In the case of a room wherein the speaker is mounted so that the front of the cone is completely isolated from the back,

(Continued on page 370)

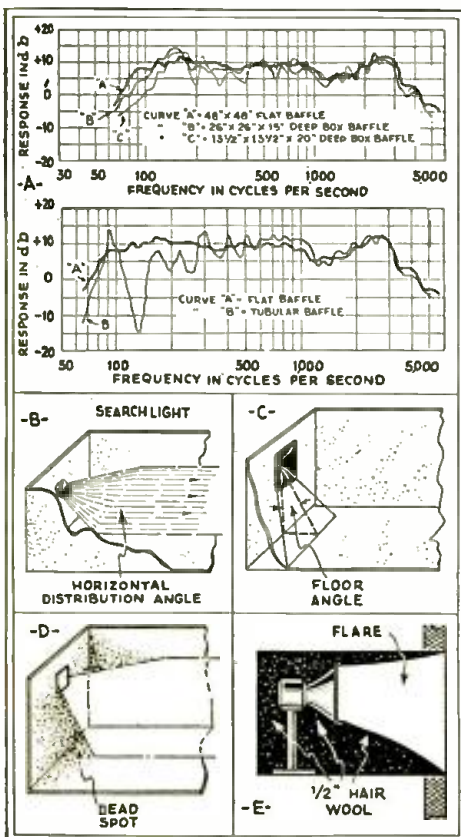

Fig. 1

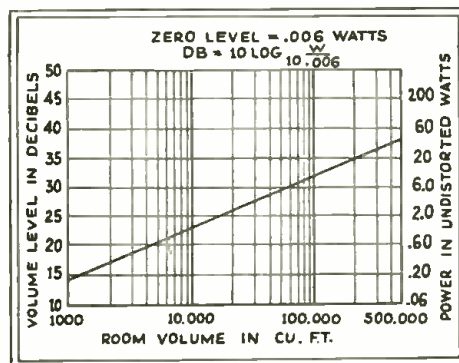
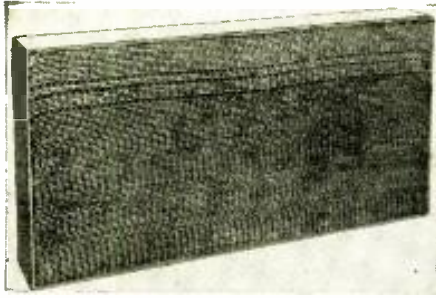

Fig. 2
Curve showing the relation between room volume and required sound level.



A photograph of material having sound-absorbing qualities. In appearance it resembles ordinary corrugated board. (Courtesy Amy Aceves & King)

THE CAUSES AND CURES OF AUDIO OSCILLATION

A complete discussion of the causes and cures of audio oscillation with special reference to public address systems

L. VAN DER MEL

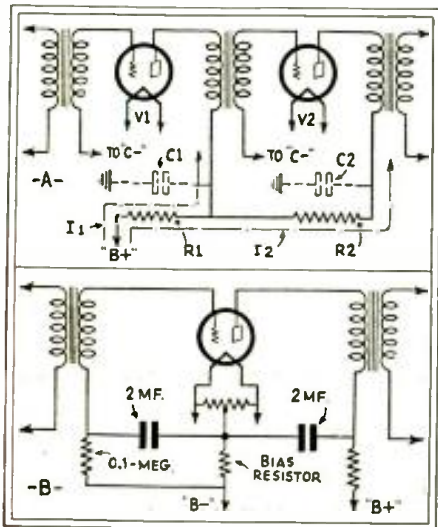

Fig. 1

Circuit illustrating the manner in which oscillations may be generated by a common impedance. Although oscillations will be small when V1 and V2 are successive stages, they will be great if V1 is a first and V2 a third stage.

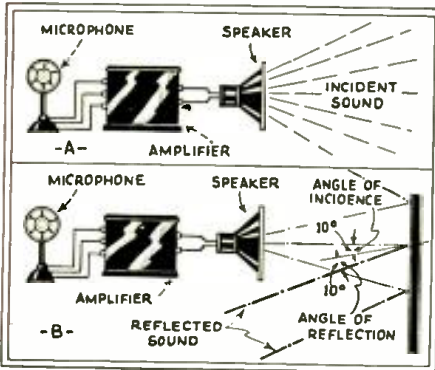

Fig. 2

At A, incident and at B incident and reflected sound waves.

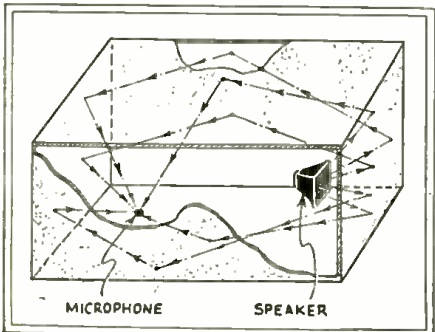

Fig. 3

Illustrating the manner in which a sound wave may be reflected by the walls, ceiling, and floor of a room. Follow the arrows.

MOST really good contributions to knowledge cannot be carried to extremes, and oscillation, in one form or another, is no exception to this commonly accepted axiom. Intentional regeneration in R.F. and, very often, in A.F. amplifiers has been one of the major steps in the development of radio; but, as stated above, becomes the most destructive of forces when used in excess or when not wanted.

The subject of oscillation control in R.F. circuits has been treated so often and to such an extent that repetition would be boring; oscillation control in A.F. circuits has not been discussed to any appreciable length lately, so an attempt is made here to lay before the reader the causes, and what is far more important, the cures of audio oscillation.

Oscillation in the Amplifier

There are two possible causes of audio oscillation; (1) that due to improper design of the amplifier itself; and (2) that due to feedback from a loudspeaker to a microphone, both of which are connected to the audio amplifier in the conventional manner.

The first cause of oscillation may be cured only by electrical means, but the second cause may only be eliminated by mechanical methods, since the source of the trouble is due to the kinetic energy (energy due to motion) of the sound wave issuing from the speaker and entering the microphone. Each of these methods will be treated in detail, in turn.

In order for oscillation to take place, energy must be transferred from one portion of a circuit to another, without the aid of an external source of energy. In a vacuum tube, energy may be fed from the plate to the grid circuit either through the internal capacity of the tube itself or by means of external coils and condensers, and if the energy fed back is sufficient to overcome the losses in the grid circuit, the tube will generate self-sustained oscillations. The one requisite, however, is that the resistance of the circuit, R , must be less than $4LC$, where L is the inductance and C is the capacity of the circuit. If R is greater than $4LC$, there will be no self-sustained oscillations.

In an audio circuit, it is very unlikely that energy will be fed from the plate to the grid circuit via the tube capacity because of the relatively small internal capacity of the tube compared with the frequencies used; but it is possible that energy from one circuit (either the plate circuit of a tube, or the grid or plate circuit of another tube) may induce a voltage in a grid circuit, which will be amplified by the tube, fed back to the grid circuit again, etc., generating oscillations of a troublesome nature. Oscillations arising from such causes are due to *interstage coupling*.

The obvious remedy, of course, is to so place the individual units such as transformers, chokes, etc., so that the coefficient of coupling (degree of coupling) between any two coils is a minimum. The best position may easily be determined by connecting up the amplifier and adjusting the position of the various units until the oscillation ceases.

Another cause of oscillation is improper grounding of the amplifier and its associated units. If the potential of the grid-return is not held fixed but assumes any value determined by local conditions, the potential of the grid with respect to the cathode will fluctuate, resulting in oscillation. If the source of "B" potential is a power unit, then the variation in grid potential will take place at double the frequency of the power supply, i.e., 120 cycles, giving a decided hum.

"Motorboating" in resistance-coupled amplifiers is not an uncommon occurrence, and is, in reality, a low-frequency oscillation. It is caused, in most cases, by the variation in voltage on the grid of a tube due to coupling through a common impedance. This point will be further discussed.

In transformer-coupled amplifier circuits, oscillation, if not due to improper placement of the components parts, is present because of coupling through a common impedance. The idea may be represented by Fig. 1A. The plate current of tube V2 must flow through R1 and R2, through the tube, to the B—. The plate current of tube V1 must flow through R1, through the tube to the B—. The result is that, if

(Continued on page 373)

RADIO-CRAFT'S CHART OF INTERMEDIATE FREQUENCIES

● MANY SERVICE MEN are laboring under the erroneous impression that 175 kc. is the "standard" intermediate frequency used in present-day broadcast superheterodynes. So much publicity was given this particular frequency when the "super" returned to popular favor two seasons ago that they overlooked completely the great amount of development work done since that time. More than one repair man has vainly tried to line up supers at 175 kc. when the actual working frequency was either higher or lower!

For the benefit of Service Men, we circularized all domestic radio manufacturers known to be in business, asking them simply for the I. F. used in all supers that they now make or ever made. This list which follows represents the total response to date. If further "dope" is received, we will publish a similar list in the near future.

ALL-AMERICAN MOHAWK CORP.
Lyric models S-6, S-7, S-8, S-10, S-63, S-65, DC-65, B-80, S-80, SA-90, SA-130175 kc.
Lyric models SW-8, SW-80484 kc.

ATWATER KENT MFG. CO.
Model 91 Auto Radio..260 kc.
All other models.....130 kc.

AUDIOLA RADIO CO.
All models.....177.5 kc.

BALKEIT RADIO CO.
Models L7, 55, 85.....175 kc.

BELMONT RADIO CORP.
5 tube models 51B, 51C and 55B; 7 tube models 71 and 71A; 8 tube model 81; 11 tube models 110 and 110A175 kc.

BROWNING DRAKE RADIO CORP.
Models 40 and 80.....175 kc.

CANADIAN WESTINGHOUSE CO., LTD.
Models 89, 90, 99, 99A, 110, 120.....171 kc.
Columaires 8 and 10, and models 101, 801, 802.....178 kc.

COLONIAL RADIO CORP.
All models175 kc.

COLUMBIA PHONOGRAPH CO., INC.
C-25B chassis in C-256 receiver, C-55 chassis in C-53, C-54, C-59 receivers, C-80A chassis in C-81, C-83 receivers, C-80B chassis in C-84 receiver, C-90A chassis in C-93 receiver, C-90B chassis in C-94 receiver, C-120B chassis in C-123 receiver (battery), C-220 chassis in C-223 receiver, C-550 chassis in C-559 receiver, C-800A chassis in C-85 receiver; all.....175 kc.

CROSLEY RADIO CORP.
Models 95, 96, 129, 130, 132-1, 133, 134, 135, 137, 141181.5 kc.
Models 120, 121, 122, 123, 124, 125, 126, 127, 128, 131 175 kc.
Model 136-1 456 kc.

DE FOREST CROSLEY RADIO (A Division of Consolidated Industries, Ltd.)
1931 Models: all Challenger models; Encore (500), Ballad (501), Carol (705A), Musicale (707A), Little Symphony (840), Rhapsody (850), Carillon (853), Clifton (405C), Canterbury (405A), Chesterfield

(405B), Westminster (405D-E-F), Westminster Universal (607), Prelude (905), Belcanto (907), DX-Plus (855B), Herald (855); 1932 Models: Windsor (608A), Renwick (608C), York (851A), Mayfair (851C), Embassy (801), Battery Montrose (902), Balmoral (140); All175 kc.

DELCO APPLIANCE CORP.
32 volt D. C. Superheterodyne 110 volt A. C. Superheterodyne175 kc.

ECHOPHONE RADIO MFG. CO. LTD.
Models 62, 72, 92...115 kc.
S-5, S-5 Special, 5, 10, 15, 20, 35, 50, 55, 60, 65, 70, 75, 80, 90175 kc.

EMERSON RADIO & PHONOGRAPH CORP.
Model AW-55 Six tube Superheterodyne445 kc.
Models CS-52, JS-53, KS-70, KS-80175 kc.

FADA RADIO & ELECTRIC CORP.
KU 45, KW 48 and 49, KO 51, KOC 53 and 57, KX 61 and 63, KY 66, RE 73 and 85, RC 78 and 79, RA 74, 76, 83, 87, 88 and 89,

RF 732 and 852; All175 kc.
(Note that besides the model number there are letter designations. These appear after the serial number of the receiver and they help designate the type chassis. For instance, a receiver bearing serial number 0000-RE will indicate that the chassis could be one from either a model 73 or a model 85.)

GENERAL ELECTRIC COMPANY
All models175 kc.

GRIGSBY-GRUNOW CO.
All models175 kc.

GULBRANSEN COMPANY
Models 130, 135, 235, 236, 237, 530, 535, 925, 3225, 3226, 3925, 8726..175 kc.
Models 3521, 3525, 3622262 kc.

HAMMARLUND MFG. CO.
Comet All Wave Superheterodyne, Comet Pro, Models A and B.....468 kc.

CHARLES HOODWIN CO.
6 tube Midget, 6 tube Auto set.....175 kc.
All-Wave Chassis.....456 kc.

HOWARD RADIO CO.
Letters indicate chassis model, numbers the corresponding cabinet

models. H (35, 40),
A V H (45, 60),
O (20, 25, 30),
A V O (35A), DL
(500, 501), K
(400), L (420),
M, EX175 kc.
Automobile receivers260 kc.

KELLER-FULLER MFG. CO. LTD.

Los Angeles, Cal.
Radiette Models
70, 80, 90, 120,
and 50S175 kc.

COLIN B. KENNEDY CORP.

Models 52, 56, 62,
62A, 62B, 63, 64,
64B, 66, 66A, 66B
72175 kc.
Model 52 (export).....135 kc.
Model 67 (export).....110 kc.

KOLSTER RADIO, INC.

Models K-55, 60, 62,
63, 65, 66, 70, 72,
73, 75, 76, 80,
82, 83, 85, 86, 90,
92, 93, 95, 96,
100, 102, 103,
105, 106, 110, 112,
113, 114, 115, 120,
122, 123, 125, 130,
132, 133, 135, 140,
142, 143, 145, 165,
195all 175 kc.

LANG RADIO CORP.

Models MA7, MD7,
SA7, SD7, MA8,
MD8, SA8, SD8,
SA9175 kc.

C. R. LEUTZ, INC.

Special short-wave
receiver450 kc.

LINCOLN RADIO CORP.

Deluxe SW-33, DC-
SW10480 kc.

**PHILCO RADIO & TELEVISION
CORP.**

7 Philco Transitone..175 kc.
15 Series175 kc.
22, 23 Series.....260 kc.
35260 kc.
36 Series260 kc.
47 DC Series.....260 kc.
51, 52 Series.....175 kc.
70 and 70 with auto-
matic volume con-
trol260 kc.
71 Series260 kc.
90 with 45's in out-
put, and 90 with
one '47 in out-
put175 kc.
90 with two '47's in
output260 kc.
91 Series.....260 kc.
111, 112175 kc.
4 and 4C Series.....3600 kc.
adjusting frequency

PILOT RADIO & TUBE CORP.

Dragon, models 10
and 11115 kc.
Models 39, 41.....115 kc.
Models 148, 149.....175 kc.

RCA-VICTOR CO., INC.

Radiolas 60, 62, 64,
66, and 67.....180 kc.
All other RCA, RCA-
Victor and Victor

Talking Machine
receivers175 kc.

REMLER CO., LTD.

Model 10260 kc.
Model 15180 kc.

SILVER-MARSHALL, INC.

Models 36A, 41, 714,
716, 724, 724B,
726SW, 782-1040,
A, B, C, D-E, F,
G, J175 kc.
Models Q, QD, R-RT,
V, X, Y.....465 kc.

SIMPLEX RADIO CO.

Models P, P-DC, P-
Battery, T (auto-
mobile)175 kc.

SPARKS-WITHINGTON CO.

Models 10, 12, 14,
15, 16, 16AW, 18,
25, 26, 26AW, 27,
28, 30, 30A, 34,
35, 45172.5 kc.

**STROMBERG-CARLSON TELE-
PHONE MFG. CO.**

Models 19, 20, 22, 24,
25, 26, 27, 29, 38,
39, 40, 41175 kc.

**TRANSFORMER COMPANY
OF AMERICA**

Models 80, 81, 83,
84, 85, 86, 90, 91,

94, 95, 96, 100,
101, 110, 111, 120,
121, 130, 131, 160,
170, 220, 230, 260,
270, 280, 290.....175 kc.

Models 140, 150
(short wave com-
bination): on short
waves receiver is
tuned to.....600 kc.
Model 125100 kc.
Model 240490 kc.

**TRAV-LER RADIO & TELEVISION
CORP.**

Models S-9 and S-10..175 kc.

**UNITED AMERICAN BOSCH
CORP.**

Model 260517.5 kc.
All other models to
date175 kc.

WELLS GARDNER, INC.

Series O52, O62,
O72262 kc.
Series 50, 022, 572,
092175 kc.

ZENITH RADIO CORP.

Models AH, CH, RH,
LH, WH, MH, BH..175 kc.
Models 090, 90, 91,
92, 103, 210, 220,
230, 240, 245, 410,
411, 420, 430,
440175 kc.
Models 210-5, 211-5,
270-5125 kc.
Models 250, 260,
272175 and 1000 kc.

"FERROCART" R. F. COILS

DR. ALBERT NEUBURGER, Berlin

EUROPE, via the efforts of Hans Vogt, has recently become aware of the possibilities of the use of finely-divided iron as R.F. coil core material, à la the general idea disclosed in complete detail in the November, 1931, issue of RADIO-CRAFT, in the article, "Permeability Tuning."

The main advantages of this material, when used as the core of an R.F. transformer, are low resistance losses and high permeability. This latter factor manifests itself as a coil of much smaller dimensions than that ordinarily used, as pictorially represented in the photograph attached. The larger unit to the left is a coil having identical electrical characteristics—but note the difference in size!

Another distinct advantage is the fact that the material may be compressed by the application of heat and pressure; and it may be stamped, cut and sawed to almost any desired shape.

Selectivity curves of Ferrocart, in comparison with other coils having the same inductance, are distinctly steeper, indicating a lower R.F. resistance. At resonance, the response of a Ferrocart coil reaches 10 (arbitrary units). Under the same conditions, the usually efficient R.F. coil reaches 5.7, a ratio of 5.7/10 or .57. At 5 kc. off the measuring frequency, the Ferrocart coil as a response of 4.5 and the usual R.F. coil

a response of 3.5. The ratio at this point is 3.5/4.5 or .77.

The above ratios mean that at resonance the usual R.F. coil is but 57% as sensitive as a Ferrocart coil, and at 5 kc. off resonance, the usual R.F. coil is but 77% as efficient. With these figures, a figure of merit of the coil may be obtained. The above data were taken from measurements made at 300 meters, or 1,500 kc.

The decrement of the coil at 200 meters is about .04 and drops to about .01 at 600 meters, which is to be expected. In comparison with another coil which had a decrement of .06 at 200 meters and a decrement of .035 at 600 meters, the Ferrocart coil is good.

In the article "Permeability Tuning" referred to above, tuning of the coil was accomplished by varying the amount of iron in the coil; in this coil, tuning is accomplished by a standard tuning condenser.

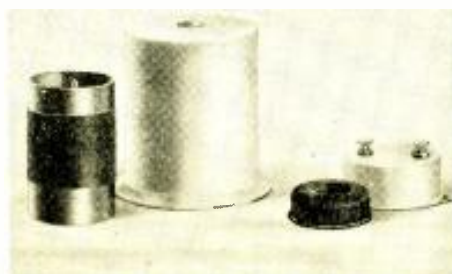

CONSTRUCTING ADAPTERS FOR

F. L. SPRAYBERRY*

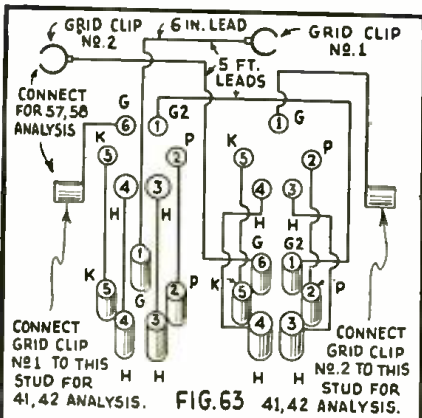

FIG. 63 41,42 ANALYSIS.

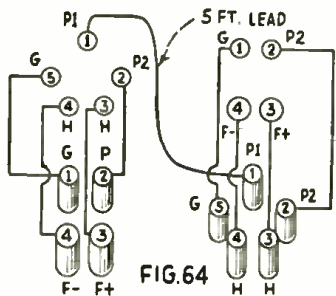

FIG. 64

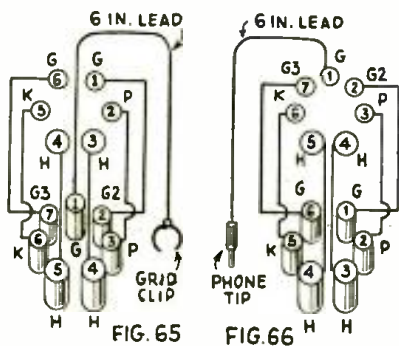

FIG. 65

FIG. 66

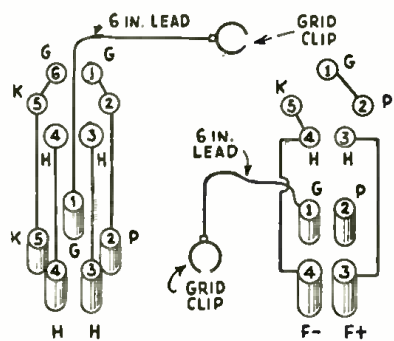

FIG. 67

FIG. 68

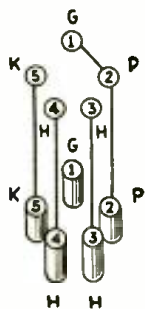

FIG. 69

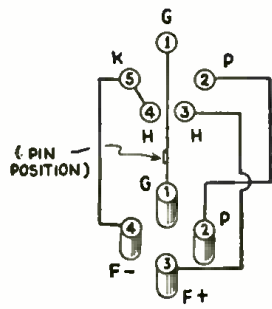

FIG. 70

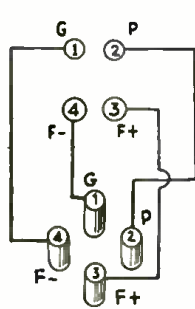

FIG. 71

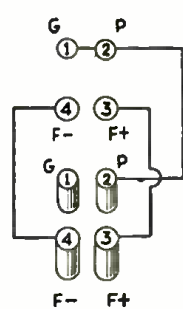

FIG. 72

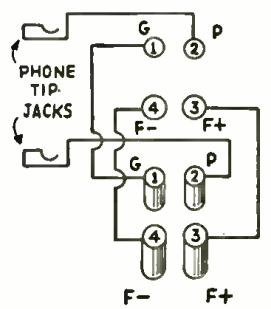

FIG. 73

WHY YOU SHOULD USE ADAPTERS

● THOUSANDS upon thousands of tube testers and set analyzers have been sold to Service Men prior to the announcement of the six- and seven-prong tubes. To discard such instruments, merely because they do not test some of the latest tubes, is unwise from both an economical and technical standpoint. For this reason, RADIO-CRAFT has printed in the October and November issues diagrams and descriptions of adapters suitable for testing all the latest tubes. When the series is completed, adapters designed for all of the well-known makes of testers will be described.

THIS is the third of a series of articles by Mr. Sprayberry dealing with the use of Na-Ald adapters for modernizing old test equipment. In the October and November issues of this magazine adapters suitable for use with Jewell analyzers were discussed; in this issue, we proceed with a discussion of adapters for use with Weston and Supreme apparatus.

Adapters for Weston Testers

No. 932, Fig. 5, is used with the model 537 tester to analyze the '22, '32 and '34 tube circuits.

No. 992, Fig. 6, is used with the model 537 tester to analyze the '24, '35, '36, '38, '39, 44 and '51 tube circuits.

No. 965DD, Fig. 63, is used with the model 537 tester to analyze the circuits of the 29, 41, 42, 55, 57, 58, 69, 85, 89, PA, PZH and 6-prong Wunderlich tubes making possible the measurement of plate current, plate voltage and control-grid bias.

*Service Consultant, National Radio Institute.

No. 955DGLC, Fig. 45, makes possible the direct analysis of the 1st section of the triple-twin tubes with the model 537 analyzer.

No. 955DPP, Fig. 46, is used with models 547, 565, 566, 589, 593, and 660 testers for direct analysis of the 1st section of the triple-twin tubes.

No. 954DP, Fig. 64, is used with models 537, 547, 565, 566, 589, 593 and 660 testers for direct analysis of the 2nd section of the triple-twin tubes.

No. 955GGKC, Fig. 47, is used with all models of Weston analyzers to secure direct analysis of the 5-prong Wunderlich tube circuits. This adapter is used on the 5-prong analyzer plug or the 5-prong adapter of a 4-prong analyzer plug.

No. 955GGKL, Fig. 48, is used in the 5-prong analyzer socket in conjunction with the No. 955GGKC adapter for 5-prong Wunderlich tube analysis.

No. 975DD, Fig. 49, is a twin adapter to be used with the model 537 tester for analysis of 7-prong tube circuits enabling plate current and voltage, filament voltage and grid-bias readings to be taken.

No. 975DW, Fig. 50, is a twin adapter for use with models 547, 565, 566, 589 and 593 testers to analyze the circuits of the 7-prong tube. This adapter enables plate voltage, screen-grid voltage, control-grid voltage, filament voltage, cathode voltage, plate current and screen current readings to be taken.

No. 975DSW, Fig. 51, is like the No. 975DW excepting that it has a center stud for locking into the latch of the analyzer plug of the model 565 tester, Type 5.

No. 967SGL, Fig. 65, is used on the

This third article by Mr. Sprayberry describes in detail adapters for use with Weston and Supreme apparatus.

TEST EQUIPMENT

6-prong analyzer plug of the model 660 tester, and the No. 976GL, Fig. 66, is used in the 6-prong socket of the tester for analyzing 7-prong tube circuits.

No. 968R, Fig. 54, is used with Weston models 533, 555, 565, 593 and 597 testers to check the WD11 tube in the '26 socket.

No. 944R1, Fig. 55, is used with the above Weston models for checking the 864 tube in the '26 socket.

No. 972R1, Fig. 56, is used with the above Weston models for checking the 215A tube in the '26 socket.

No. 944GL, Fig. 62, is used with the Weston model 565 tester for analyzing '32 and '34 tubes.

No. 954KPC, Fig. 15, is used with Weston models 533, 555, 565 and 593 testers for checking '33, '46, '47, GA, LA and PZ tubes.

No. 955GGKL, Fig. 48, is used in any Weston tube checker to test the Wunderlich 5-prong tube. Place in '27 socket.

No. 965GG, Fig. 28, checks the 29 and Wunderlich 6-prong "A" tube in the '27 socket; and the 69 and Wunderlich "B" tube in the '27 socket with 6.3 V. heater voltage of any Weston tube checker.

No. 965-55, Fig. 26, is used with all models of Weston testers for checking the 55 tube in the '27 socket. This adapter also checks the 85 tube when placed in the '37 socket or when 6.3 volts is applied to the heater terminals of the '27 socket.

No. 965KPGL, Fig. 67, is used with Weston models 533 and 565 testers for checking the 57 and 58 tubes in the '27 socket.

No. 944LS, Fig. 44, is used with the Weston model 597 testers for checking the overhead heater tubes.

No. 429, Fig. 40, is used with all models of Weston testers for checking UV199 tubes.

No. 944GL, Fig. 62, is used with models 533, 555, 565 and 593 testers for checking the '22 tubes. This adapter also checks the 865 tube in the model 597 tester.

No. 979WE, Fig. 57, is used with models 533, 555, 565 and 593 testers for checking the Western Electric 205D tube. This adapter may be used with a No. 954 adapter to check the 205I tube with the Weston Model 597 checker.

No. 954KPC, Fig. 15, is used with the model 597 tester to check the GA tube.

No. 954SGL, Fig. 68, is used with the Weston model 565 tester to check the '36, '38, '39, '44, '64, '65 and 68 tubes.

No. 965PG, Fig. 25, is used with models 533 and 565 testers for checking the 41, 42, PZ and PZH tubes.

No. 965KS, Fig. 16, also checks the 89 tube in models 555, 593 and 597.

No. 965KPGL, Fig. 67, checks the 89 tube in models 533 and 565 testers.

No. 975KP, Fig. 35, checks the new 7-prong power amplifier with any Weston tube tester.

No. 954GL, Fig. 53, is for testing the circuits of pentode tubes with models 547, 565 and 566 testers. It is to be placed in socket of tester.

No. 945GL, Fig. 52, same as for the No. 954GL with the exception that it is attached to the test plug.

No. 954DS, Fig. 20, is used with models 565-5 and 566-3 testers.

No. 965DW, Fig. 8, is used with the model 565-5 tester for test on 57 and 58 tube circuits.

(Continued on page 365)

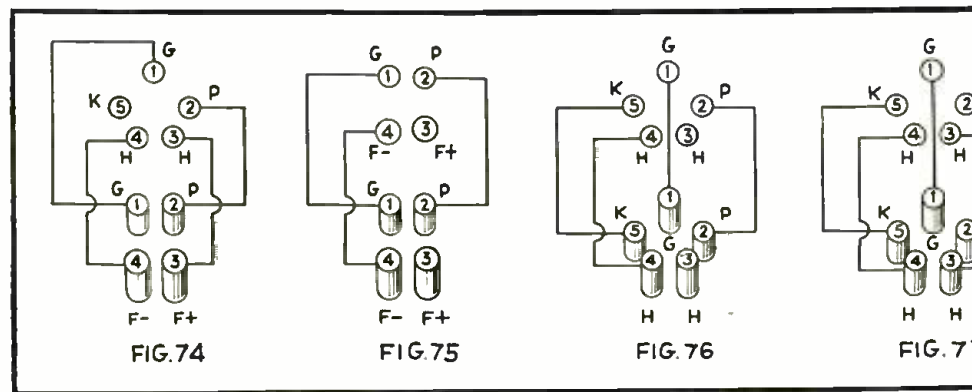
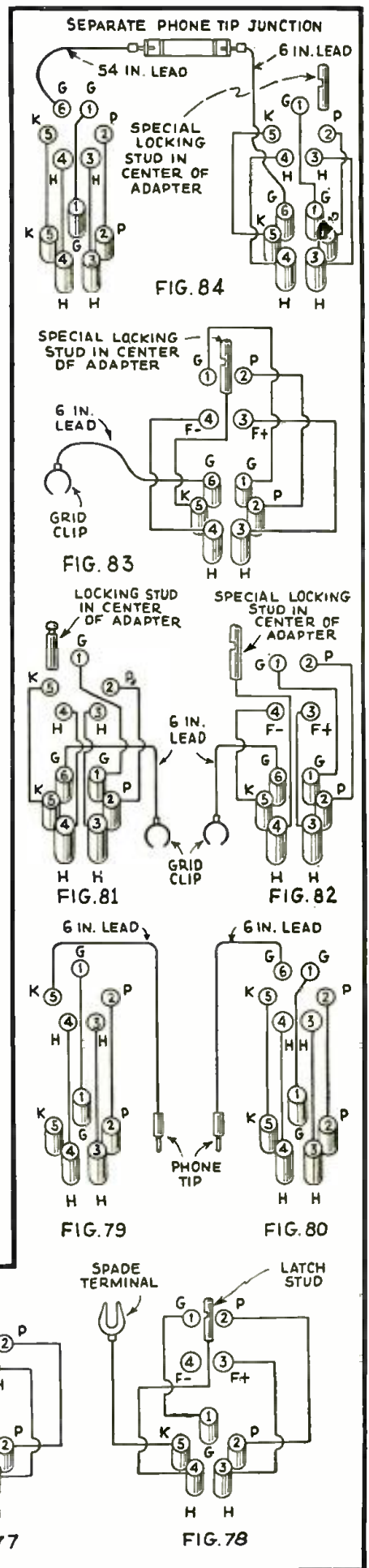

Diagrams of adapters for Figs. 74 to 84 inclusive. In issues to follow, adapters suitable for additional testers will be given.

THE SERVICE MAN'S FORUM

Where His Findings May Benefit Other Radio Technicians

WHEN THE SET'S "ALL WET"— PAGE MR. GIBBONS!

Editor, RADIO-CRAFT:

I read with interest, in RADIO-CRAFT, the different experiences of Service Men throughout the country. Now, I am prompted to submit to the readers the following rather interesting experience.

One of my customers recently purchased a battery-operated Eagle radio set which would not operate. After testing the circuits and carefully going over the receiver I found that dampness had got into one of the audio transformers. This moisture then was absorbed by the paper wrapping and, expanding, had broken one of the hair-like strands of the secondary.

After putting in a new transformer and carefully drying out the set by putting lighted electric lamps in it near the coils, we hooked it up and it played and sounded as good as when new. Luckily, the man who owned the set heard it play in our lab., while we were testing it.

He took the set home, fully satisfied that it was going to play and that we had done a good job (which we felt we had)—but Ah-h-h-h! He dropped into the place the next day and Oh! Boy—was he mad! He told us we had charged him to fix his radio and it wouldn't play—and were we surprised!

I first contended that he must have hooked it up wrong so, to compromise with him and to keep customer goodwill, without losing any money, I agreed to go to his home, about seven miles away, for traveling expenses only, if it was the fault of our workmanship. On the other hand, he agreed to pay us for my time and expenses if the fault was his.

Upon arriving at his home I noted that the set was in a room directly over a basement. Next, I turned on the receiver, the side-tone was normal and a buzz resulted when I touched the grid connection of the detector—audio end, O. K.

What? The coils look damp again? Sure enough; damp enough so that a mark is left by touching them. Well, after a little quizzing, the customer admitted that the room was damp, and also that the same trouble developed at his brother's house, even with a cook stove burning.

Consequently, I decided to take the set back to the shop, dry out the R. F. coils so that the set would play, and then leave the set in the shop over night, as I was sure there was no dampness in our place (heating engineers had previously tested for dampness before installing an oil furnace).

...the first sign of a turn, it continues.

oooooooooooooooooooooooooooo

GIBBON'S RADIO COLUMN

Radio Questions answered
in this column every week.

Free!

Send in your troubles. Address Radio Editor, in care of this paper.

oooooooooooooooooooooooooooo

THE D.X.ers GLORY.

How do you do friends of the air. Happened to be at a town called Westbrookville. N. Y. recently and became acquainted with a chap who is a short wave fan so went to his home and to our surprise heard Madrid, Spain with enough volume for loud speaker reception and held the program for the entire supper hour. I was so completely bewildered I didn't leave the speaker. Several other European stations were heard and with volume and a new thrill has been added to our radio adventures. So far I believe we've found the best spot in this section of the world as far as D.X. reception is concerned as the best set in the world depends upon the location in which it is used.

QUESTIONS AND ANSWERS

Q— Please give me the address of Philco as my socket power has a burned out fuse on the Det. tap and I want a new one. T.B. Milford
A— Address is Philadelphia, Pa. The Det. tap has no fuse on it as it is a fixed resistance of 100,000 ohms.

Q— Does a radio work as well plugged in the lamp socket as it would in a receptacle or floor plug. It is a Sparton Type 89A? B.N.J. Goshen, N.Y.

A— It will work in the lamp socket but the plug is the best as a lamp cord offers more resistance than the plug thereby cutting down the current supply to the set.

Meet me here next week.

JOE GIBBONS

Mr. Gibbon's column. He "takes the resistance out of radio."

Next morning, when I came to work I noticed that the coils were again damp and that the set would not play! Believe me, I sure was puzzled, so I decided to follow up one more hunch.

I went to the drug store and got some blue litmus paper. Returning to the shop, I touched the coils with the litmus paper; it turned pink, indicating an acid condition which was causing the coils to absorb moisture, no matter how many times they were dried out.

The first step was to neutralize the acid, which I did by soaking the coils overnight in ammonia. After drying out the coils by placing them close to a bank of lighted electric light bulbs I coated the coils with pure orange shellac.

The set has been playing now for five months and the customer is so well pleased he has sent us plenty of other customers.

In several subsequent cases we have found this same "dampness trouble" affecting the battery set, especially where the set is installed directly over the storage "A" battery, as the fumes of the acid seem to creep into the coils. It is my belief that this trouble is causing a loss of volume, or "kick," in battery sets. Now, our motto regarding a battery set powered by a storage "A" or "B" battery is, "Keep the battery away from the set."

Hope this information helps out the bunch.

JOE E. GIBBONS,

Pioneer Radio Laboratories, 16 Holden Building, Port Jervis, N. Y.

(We thank the Pioneer Radio and Detective Laboratories for this tale of a job well done. There is no better recommendation than the customer who comes back for more.—Editor)

THE Official Radio Service Men's Association, sponsored by RADIO-CRAFT, invites all Service Men who are not members of the Organization to write for an application blank. It is the official service organization of this magazine and is main-



Official lapel button of the O. R. S. M. A.

tained solely for the interests of Service Men. Membership cards are issued upon passing a written examination which is forwarded by mail. Write for yours today. The O.R.S.M.A., 98 Park Place, N. Y.

THE ANALYSIS OF RADIO RECEIVER SYMPTOMS

OPERATING NOTES

COLONIAL 33 RESISTORS

Oscar Block

IN THE Colonial 33 series and in other sets using lavite, graphited, or similar voltage-divider resistors, a frequent cause for either low plate- or screen-grid voltage, high control-grid bias, or grid blocking is the rise of the resistor's value due to its element disintegrating in operation or its contacts becoming imperfect.

The simplest procedure to follow in effecting a cure where the desired resistance values are in doubt is to connect a high resistance voltmeter across the tube and to shunt the voltage divider sections with small, carbon, pig-tailed resistors of sufficient current-carrying capacity until the proper voltages have been obtained. It is well to check all the voltages again after tentative resistance values have been selected, as a change of resistance in one section is apt to change the voltages across all sections. This cure is preferable to changing any resistor whose value has changed, since unless a complete open is encountered, the parallel resistors will have a greater current-carrying capacity. This idea is shown in Fig. 1.

APEX No. 10

By Adolph Kohnert

STATIC and noise was the complaint on an Apex No. 10, brought into the shop for repairs after all efforts failed to fix the set in the field. Tests revealed that the noise, sounding like a noisy tube, was due to an 8 mf., dry electrolytic, paper case condenser which bypasses the detector plate feed resistor. This trouble occurred in several sets of this model, and was eliminated by replacement of the condenser.

BOSCH 73

A peculiar trouble was had with a Bosch 73. The customer reported "something burned." The set was turned on and found to be in playing order. The chassis was removed from the cabinet and a black, with yellow-tip resistor was found to be burned. This resistor has a value of 5,000 ohms and feeds the plate of the second R.F. screen-grid tube. All associated circuits and parts were checked and found O.K.; so were all tubes. At last, the customer was questioned regarding the set. He revealed that he had the tubes tested and switched the tubes around and in so doing inserted a '27 tube in a '24 tube socket, but corrected this before the Service Man got there. When the '27 tube was put in a '24 tube socket, the tube was drawing 40 ma. (plate current) due to the applied screen-grid

WHAT THIS DEPARTMENT IS FOR

It is conducted especially for the professional Service Man. In it will be found the most unusual troubles encountered in radio service work, written, in a practical manner, by Service Men for you.

Have you, as a professional man, encountered any unusual or interesting Service Kinks that may help your fellow workers? If so, let us have them. They will be paid for, upon publication, at regular space rates.

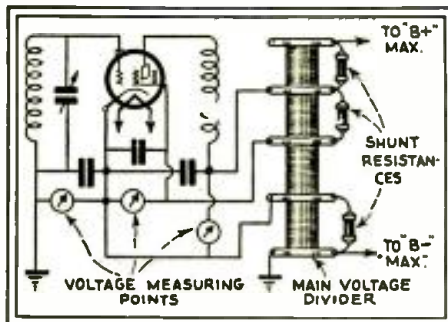

Fig. 1
Connections for the pig-tail resistors.

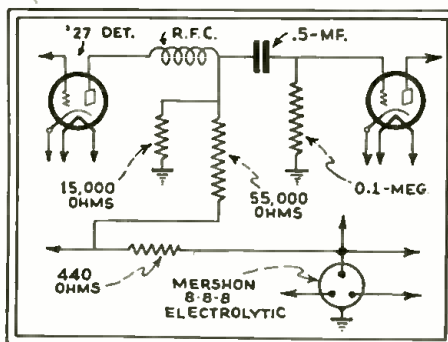

Fig. 2
Insertion of the 15,000-ohm resistor improves reception in this receiver.

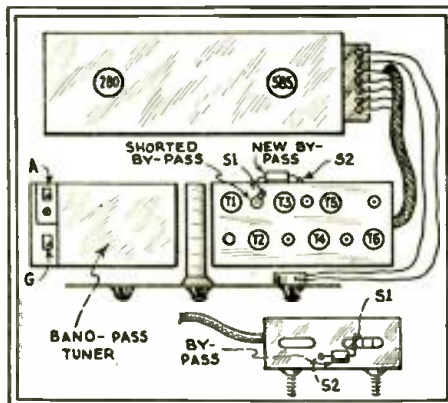

Fig. 3
Chassis layout, showing where to find the parts.

volts being on the control grid. *This again shows how important it is to question the customer regarding his set.*

On another of the same model, the set was playing with low volume when first turned on, but would, in about ten minutes, suddenly play normally. This trouble was caused by an open third R.F. screen-grid resistor. This is a 750-ohm, flat, wire-wound resistor. It was replaced by a 1. watt carbon type.

CROSLEY MODELS 30S, 31S, 33S AND 34S RECEIVERS

Henley M. Hilburn

THERE are a large number of Crosley models 30S, 31S, 33S and 34S receivers in use at present that are reaching the age that calls for frequent servicing. Naturally, new tubes, realignment, and perhaps the addition of a few new plate-circuit resistors usually make the set as good as new.

However, if the Service Man will add a 15,000-ohm resistor between the positive side of the 55,000-ohm detector plate resistor and ground, he will be surprised and the customer delighted at the increase in volume and tone quality.

The location of this resistor is shown in the sketch of Fig. 2.

SPARTON RECEIVERS

Arthur B. Parker

IN all the Sparton receivers with the R.F. amplifier in one can, there is a plate bypass condenser that blows quite often. To make replacement easier and quicker, I have used the following method.

Refer to Fig. 3, a chassis layout of the set. Remove the screw "S1," and from its lug solder a wire to one plate of the new bypass condenser to be installed. The other wire from the condenser solders to the lug marked "S2." A pig-tail type condenser makes a very neat job, and it is not necessary to remove the unit from the cabinet.

APEX MODEL 36

M. R. Cooper

AN Apex 36 receiver that had been giving good service suddenly developed a queer habit of dying out with a p-l-o-p; this happening after about 30 to 40 minutes of operation. The owner who noted that the tubes were all lighted turned the set off. Perhaps 15 minutes later it was turned on again but functioned in exactly the same manner as before. The set was sent back to the company from whom it was purchased, who maintain a so called

(Continued on page 368)

BOSCH "VIBRO-POWER" TRIPLE-ACTION MODEL 312 12-TUBE "GRAND OPERA" SUPERHETERODYNE

(Dual reproducers, inter-station noise cutout, A.V.C., tone control, push-push power amplification, local-noise control, tuning meter, antenna compensator, hum control, mercury-vapor rectifier, band selectors, low-drain tubes.)

The term "Vibro-Power" undoubtedly has puzzled many persons who may have come in contact with this generalization of Bosch. The term refers to the Bosch receiver ensembles which incorporate the features enumerated above.

Triple action is obtained in the A.V.C. circuit as follows: Reduction of station noise by the application of time-delay operation; complete elimination of inter-station noise by adjustment of an auxiliary tube circuit, and; equal anti-fading or automatic volume control operation over the entire tuning band.

Following are the characteristics of the components: Resistor R1, manual volume control, 0.5-meg.; R2, tone control, 0.1-meg.; R3 hum control, 20 ohms; R22, "individual-location" noise control, 2,000 ohms; R4, R5, R17, R26, 0.1-meg.; R6, 500 ohms; R7, 0.5-meg.; R8, R10, R11, R13, 1.0 meg.; R9, 2 meg.; R12, R19, R21, 1,000 ohms; R14, R15, R16, R29, 10,000 ohms; R18, 1,500 ohms; R20, 30,000 ohms; R23, 2,800 ohms; R24, 2,400 ohms; R25, R27, 5,000 ohms; R28, 4 ohms; R30, 3,000 ohms.

Condensers C1 to C4, tuning units C1A antenna compensator and R.F. trimmer, C2A to C4A R.F. trimmers; C5 to C9, I.F. trimmers; C10, oscillator padding condenser; C11, C13, 0.1-mf.; C12, C14 to C22, C24 to C26, C30, C31, C37, C39, .05-mf.; C23, C36, C38, 100 mmf.; C27, 0.5-mf.; C28, C42, C43, 8 mf.; C29, C33, C34, C35, C41, 4 mf.; C32, .06-mf.; C40, C45, .01-mf.; C44, 2 mf.

Tube operating voltages (except filament), measured to ground, are as follows: Filament potential, all tubes, 2.4 V. Plate potential, V1, V2, 180 V.; V3, 75 V.; V4, V5, 195 V.; V6, 0.0 V.; V7, 120 V.; V8, 290 V.; V9, V10, 430 V.; V11, 2 V. Control-grid potential, except V8, 0.0 V.; V8, 30 V. Screen-grid potential, V1, 85 V.; V2, V4, V5, 90 V.; V6, 2 V.; V7, 25 V.; V7, 1.0 V.; V8, 290 V.; V9, V10, 0.0 V.; V11, 25 V. Cathode potential, V1, 3 to 6 V.; V2, 4.5 to 10 V.; V4, V5, 3.5 to 6 V.; V6, 40 V.; V7, 45 V.; V11, 0 to 45 V.

Tuning meter M operates over a range of 0 to 16 ma. The receiver consumes 80 to 150 watts, depending upon the A.F. volume:

the Underwriters Laboratory rating (12% above minimum current drain) would be 90 watts. The sensitivity of the Bosch model 312 receiver is 1 to 2 microvolts absolute, at a power output of 100 milliwatts. The A. F. response characteristics of the two reproducers (one model C and one model G) are nearly identical; each field coil has a resistance of 2,500 ohms. The recommended antenna length is 40 to 80 ft. At the front left of the chassis is the combination off-on switch and manual volume control R1; in the center, the tone control, R2; and right, tuning control; condenser C1A is located in back of the tuning control. The "individual location" control (on the side of the cabinet) varies the proportion of program background noise; sensitivity above the noise level is not affected.

The triple-diode second-detector is so designated since it acts as three diodes, as follows.

The modulated I. F. output of the I. F. amplifier is applied to the control-grid and cathode of V6; the A. F. output is developed across R1 and applied to the control-grid of V7; this disposes of one diode. The modulated I. F. output of the I. F. amplifier is also applied to the plate (to which also is tied the suppressor-grid) and cathode of V6; the A.V.C. potential is developed across R8 and applied to the control-grids of V1, V2, V4 and V5 only when this potential exceeds the control-grid potential of 40 volts (the D.C. drop across the total resistance of R22, one end of which connects to the secondary of I. F. T. 3); this disposes of the second diode. The modulated I. F. output of the I. F. amplifier at the same time is applied to the screen-grid and cathode of V6; the inter-station noise suppressor potential is developed across R9 and applied to the control-grid of V11 only when this potential exceeds a pre-determined screen-grid potential between 0 and 40 Volts (the D. C. drop across the portion of R22 between the ground end and the moving arm); this disposes of the third diode.

When there is no incoming signal, tube V11 has screen-grid potential, plate potential, and

no control-grid potential. The plate therefore draws current and causes a drop across resistor R11; this potential is applied to the control-grid of V7, biasing it to plate current cut-off.

When there is an incoming signal the screen-grid of V6 draws current and the drop across R9 is applied to the control-grid of V11, biasing it to plate current cut-off, thus re-establishing the normal control-grid bias of V7. This action is assisted by the D. C. in R1 and to some extent reduces the screen-grid potential of V6 and V11.

Note that while making adjustments on the chassis the service oscillator signal should not be permitted to overload the tubes, as this will result in incorrect settings.

To make adjustments of the I. F. portion of the set, adjust R1 to maximum, set R2 on treble, and ground the antenna lead. Then, connect the 175 kc. service oscillator to the control-grid of V2, and align C9 for maximum output. Next, rig up an alignment "losser" consisting of a 25,000 ohm resistor and a 250 mmf. fixed condenser, and ground one of the two leads; the other end is to be connected either to the grid or the plate circuit of a tube, as directed. With the free terminal of the losser connected to the control-grid of V5, adjust C7; then, with the losser connected to the plate of V4, adjust C8. Finally, connect the losser to the control-grid of V4, and adjust C5; then, with the losser connected to the plate of V2, adjust C6.

To align the oscillator circuits, adjust trimmer C4A for maximum output (with the set pointer past 550 kc.) from a 1,400 kc. service oscillator connected to the control-grid of V2. Note that when adjusting C4A two peaks may be obtained; after tightening the C4A adjusting screw, release it about 1/2-turn until the peak at 1,575 kc. is obtained (otherwise the oscillator will not track in the center of the scale); then, align C1A, C2A and C3A. Finally, set the service oscillator for 600 kc. and adjust padding condenser C10.

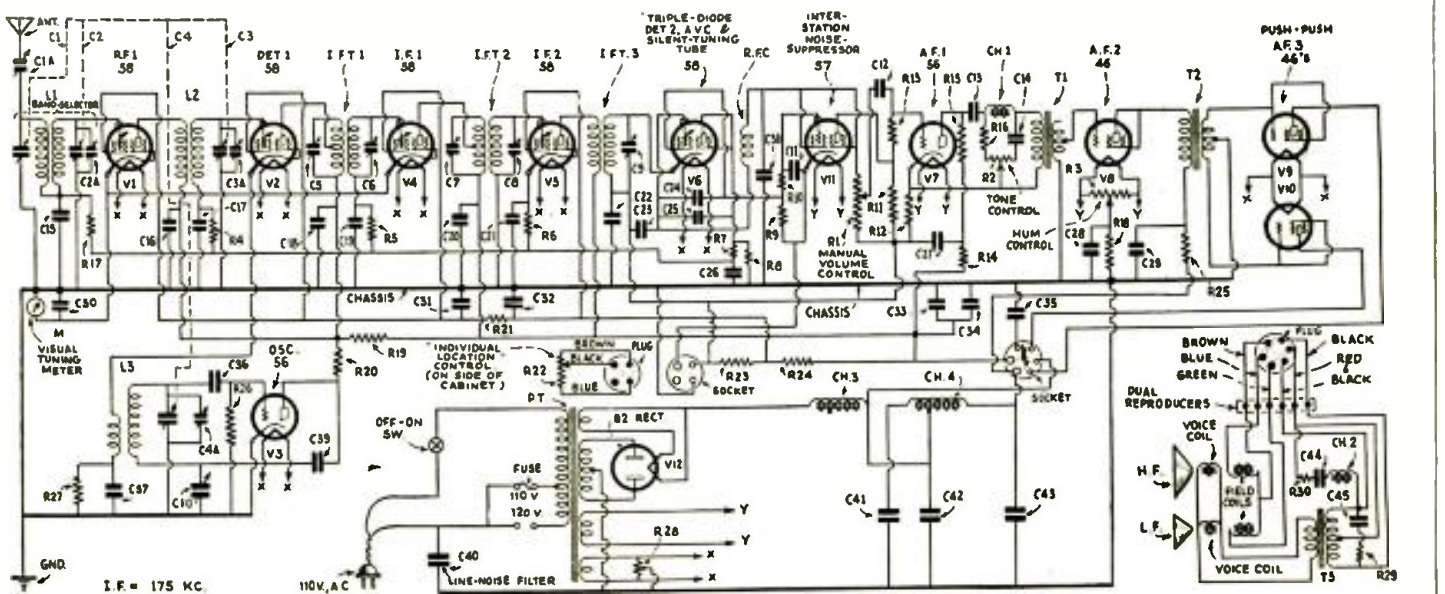

SPARTON "TRIOLIAN" 13-TUBE MODEL 28 3-SPEAKER SUPERHETERODYNE

(Inter-station noise suppressor, parallel push-pull pentodes, duo-diode detector with twin 56's, line-noise filter, tone control, hum control, Lafoy delayed A. V. C., parallel '80's, R. F. and I. F. band-selectors.)

Service Men will find after studying the schematic diagram of the new Sparton "Triolian" 3-speaker superheterodyne that although at first glance the circuit arrangement is apparently quite simple, there is incorporated in the ensemble a multiplicity of operations which make it essential for each component to have exactly its rated value, consequently, no tolerance from the specified values should be permitted when making replacements.

The Lafoy system of delayed A. V. C. discussed in RADIO-CRAFT Data Sheet No. 70, July 1932, page 37, in connection with the Sparton model 40 receiver, is incorporated in the Sparton model 28 superheterodyne. The sensitivity of the set is 4 microvolts absolute, across the broadcast band, with an undistorted power output of 20 watts. The combination first-detector and oscillator, V2, in addition to performing these functions also has a gain figure of 40 to 1.

Following are the values of the components: Resistor R1, manual volume control, 10,000 ohms; R2, tone control, 0.1-meg.; R3, inter-station noise control, 9 megohms; R4, 3,000 ohms; R5, 8,000 ohms; R6, R7, 15 ohms; R8, R10, 0.25-meg.; R9, R14, 0.5-meg.; R11, 0.75-meg.; R12, R13, 0.1-meg. Chokes RFC2 and RFC3 are 16 mhy.

Condensers C1 to C4, tuning units; C1A, antenna compensator and R. F. trimmer; C2A, C3A, C4A, R. F. trimmers; C5, .002-mf.; C6, to C9, I. F. trimmers; C10, 50 mmf.; C11, C12, C13, C27, C28, C30, 0.2-mf.; C14, C16, C17, 250 mmf.; C15, C26, .01-mf.; C18, .002-mf.; C19, .05-mf.; C20, C21, .006-mf.; C22, 4 mf.; C23, C24, C25, 5mf.; C29, 0.5-mf.

Transformer T1 has a step-down ratio of 7 to 1 for improved quality.

The three reproducers are pitched to reproduce low notes without accentuation. A 9 in. dynamic reproducer, resonant at 80 cycles, is used in the front grille, and a 7 in. dynamic reproducer, resonant at 130 cycles, in either side grille. It has been found that

by positioning these two reproducers at an angle, a "three dimension" sound effect is obtained; that is, one experiences a sensation of depth when listening to the reproduction. Choke Ch. 1, 3,700 (left) and 2,400 ohms; Ch. 2, 250 (left) and 140 ohms; Ch. 3, 3,150 ohms, center-tapped; Ch. 4, 75 ohms.

The station selector of the model 28 set is directly below the illuminated dial; below this knob is another which operates the inter-station noise suppressor, R3. At the right of the latter control is another which adjusts the tone control, R2; and at the left, the combination power switch Sw. and manual volume control R1.

Resistor R3, which controls the inter-station sensitivity of the receiver, is operated as follows: Turn R1 full on; then, tune between the station wanted and an adjacent station, and bring in the undesired between-station noise; next, rotate the R3 control knob counter-clockwise until this noise is reduced to a satisfactory level, or until it disappears entirely; now, tune in the desired program and operate R1 to raise or lower the volume as required. When tuning for distant stations, or if use of R3 is not desired, rotate the control knob of R3 clockwise as far as it will go. However, for reception of local stations this control may be used as a manual volume control, and when operated in this manner the control knob of R1 should be turned to the full position; this eliminates the A.V.C. feature and permits the received signals to fade out and in if atmospheric conditions permit.

To adjust antenna equalizer C1A, tune in a weak station between 1,400 and 1,500 kc., and turn the volume control on full; then, adjust C1A (by means of a hex-socket wrench) for maximum output. Adjust C1A only when the aerial circuit is changed. The recommended antenna length is 50 to 100 ft., and height, 25 to 50 ft.

It is preferable to use as a replacement for V2 a tube of similar characteristics, so that

the dial kc. readings for stations above 1,200 kc. are not altered. If the tuning dial goes off-scale, adjust trimmer C4A before any others, at 1,400, 900 and 600 kc., as required.

Before adjusting the oscillator, R.F. or I.F. circuits, set R1 full on, R2 full left (natural tone), and R3 full clockwise. It is preferable to use a crystal-controlled, A.F. modulated 172.5 kc. oscillator; its broadcast harmonics will be: 690, 862.5, 1,035, 1,207.5, 1,380, and 1,552.5 kc.

Two peaks will be noted within a one-half or three-quarter turn adjustment of trimmer C3A; the correct peak is obtained with the down adjustment (capacity increase). Unless the latter setting is obtained, tuning dead spots will occur at 1,300 and 1,450 kc., together with poor sensitivity at 900 and 600 kc.

To maintain the A.V.C. inactive, (that is, to prevent the action of the A.V.C. from keeping the signal at one level), in order to obtain accurate condenser adjustments, set R1 to full on and R3 counter-clockwise.

Symptoms and remedies: Dial calibration incorrect; align oscillator. Weak reception, multiple peaks within a 40 kc. band from a loud local station, or hiss; align preselector circuits. When replacing an I.F. condenser or transformer, or when these circuits are out of alignment; align I.F. circuits.

Following are the Sparton model 28 tube average operating characteristics, with a line potential of 115 V, and R1 full on: Filament potential, V1 to V11, 2.4 V.; V12, V13, 4.4 V. Control-grid potential, V1, V3, 2.4 V.; V2, 7 V.; V4, V5, (*) V6, 9 V.; V7 to V10, 25 V.; V11, 65 V. Screen-grid potential, V1 to V3, 94 V.; V7 to V10, 295 V. Plate potential, V1, to V3, 173 V.; V4, V5, (*) V6, 9 V.; V7 to V10, 285 V.; V11, 40 V.; V12, V13, 348 V. Plate current, V1, V3, 6.5 ma.; V2, 1.1 ma.; V4, V5, (*) V6, 5.5 ma.; V7 to V10, 26 ma.; V11, zero; V12, V13, 39 ma. (per plate). (*) A potential is present only when a signal is applied.

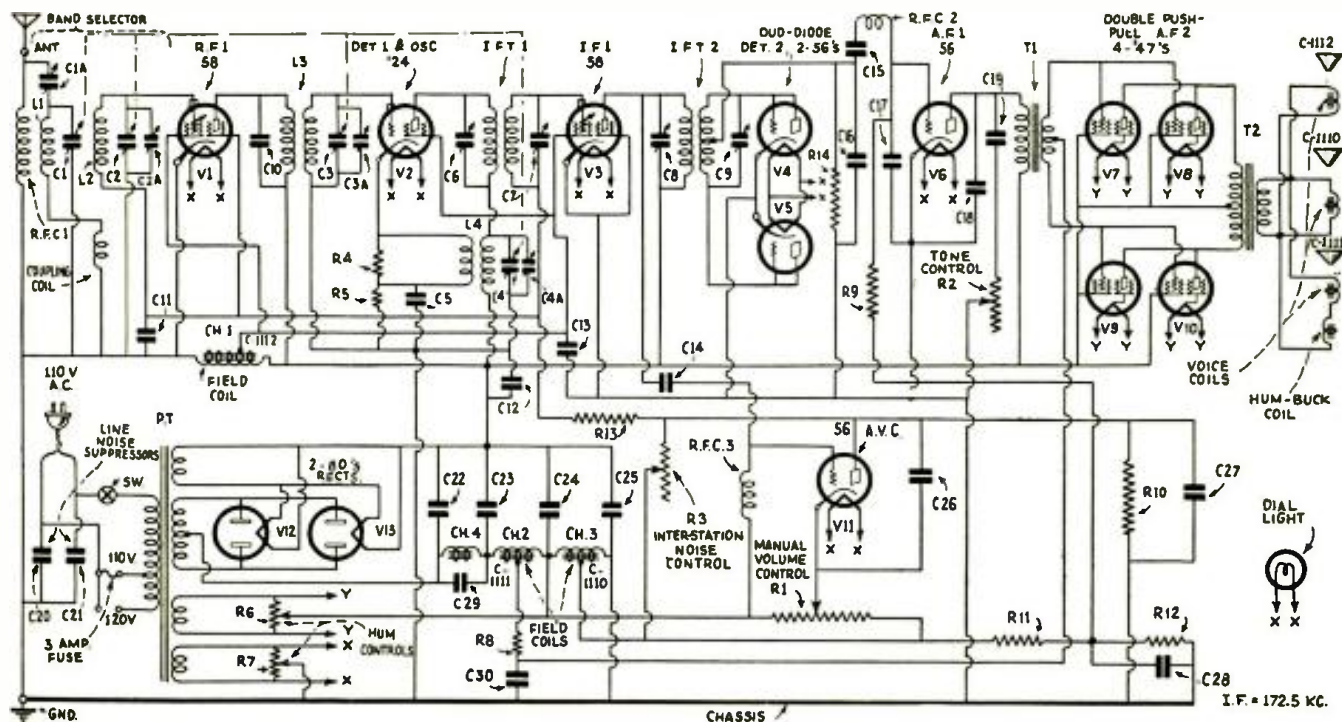

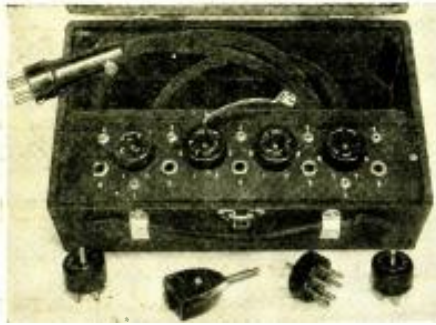

Fig. A
Photograph of the Analyzer Adapter unit.

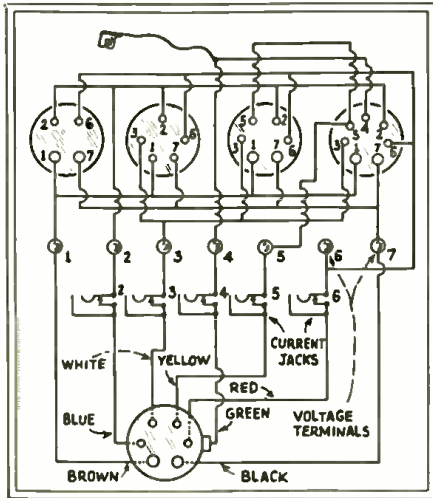

Fig. 1
Complete schematic circuit of the Analyzer Adapter unit.

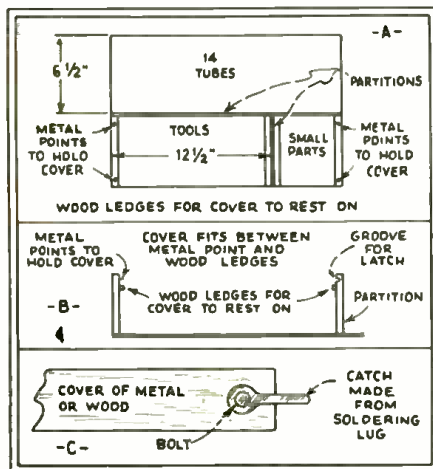

Fig. 2
Dividing up the suit case for use as a tool kit.

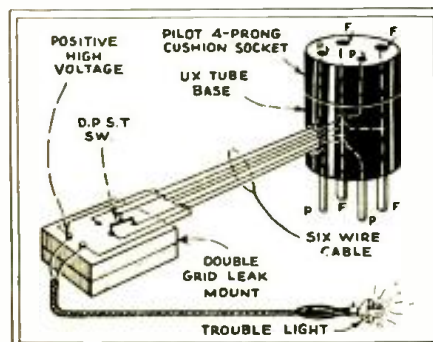

Fig. 3
Use this idea for testing rectifier tubes.

SHORT CUTS IN RADIO SERVICE

\$10 for Prize Service Wrinkles

Previous experience has indicated that many Service Men, during their daily work, have run across some very excellent Wrinkles, which would be of great interest to their fellow Service Men.

As an incentive toward obtaining information of this type, RADIO-CRAFT will pay \$10.00 to the Service Man submitting the best all-around Radio Service Wrinkle each month. All checks are mailed upon publication.

The judges are the editors of RADIO-CRAFT, and their decisions are final. No unused manuscripts can be returned.

Follow these simple rules: Write, or preferably type, on one side of the sheet, giving a clear description of the best Radio Service Wrinkle you know of. Simple sketches in free-hand are satisfactory, as long as they explain the idea. You may send in as many Wrinkles as you please. Everyone is eligible for the prize except employees of RADIO-CRAFT and their families.

The contest closes the 15th of every month, by which time all the Wrinkles must be received for the next month.

Send all contributions to the Editor, Service Wrinkles, c-o RADIO-CRAFT, 98 Park Place, New York City.

Prize Award

AN ANALYZER ADAPTER UNIT
Solomon Perlman, E.E.

SERVICE Men will welcome the analyzer adapter unit illustrated in Fig. A; its circuit of connections is clearly indicated in Fig. 1. This device brings the Service Man's analyzer right up-to-date for the analysis of the modern five-, six- and seven-prong tubes.

The analyzer plug in Fig. A is used with one of three adapters. Associated with the sockets are pin jacks for measuring the voltage between socket terminals; current measurements are made by means of plug-in jacks and the phone plug. The tip jacks also serve as a convenient means of making circuit resistance measurements between the tube elements and ground, with the receiver current off.

Clean all solder joints with alcohol. A feature of the adapter plug used is that the wire connecting to the screen-grid cap stud is also connected to the latch; when testing seven-prong tubes, the control grid lead is brought out to the latch stud.

List of Parts

- One Na-Ald 6-prong plug with 3 foot, 7 wire cable, type 906 WLC;
- Three Na-Ald adapters, one each of types 964-DS, 965-DS and 967-SS;
- Four Na-Ald mounting sockets, one each of 4-, 5-, 6-, and 7-prong type;
- Seven RTCo. insulated-top phone-tip jacks;
- Five Try-Mo single-closed-circuit jacks;
- One Try-Mo bakelite panel, 3 x 10 x 1/8-in.;
- One Try-Mo carrying case, 3 x 10 x 4 in. inside dimensions.

AN INEXPENSIVE TUBE AND TOOL KIT

Harry Schmidt

THE writer solved the problem of obtaining an inexpensive and suitable tool kit by adapting an "overnight" bag in a manner illustrated in Fig. 2. The one used by the writer holds fourteen tubes, soldering iron, resistors, and a number of small parts.

The procedure is to rip the lining from an overnight bag measuring about 18 x 11 x 5 1/2 ins., and then to paint the inside black. Make two thin wood partitions as shown at A and B in Fig. 2; wooden ledges are required as rests for the compartment covers, which are made of wood or metal. A catch may be made from a soldering lug as shown at C; it pivots freely and catches in a small groove in the partitions. The metal points to hold the cover are small brads driven into the side of the bag and then cut off so that 1/4-in. projects and holds the cover.

(Continued on page 377)

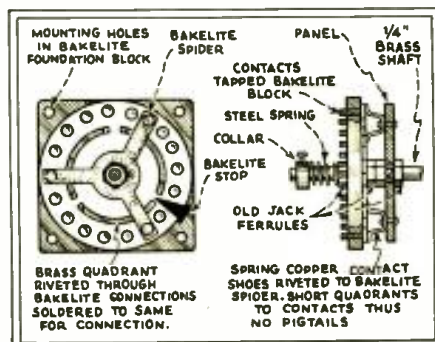
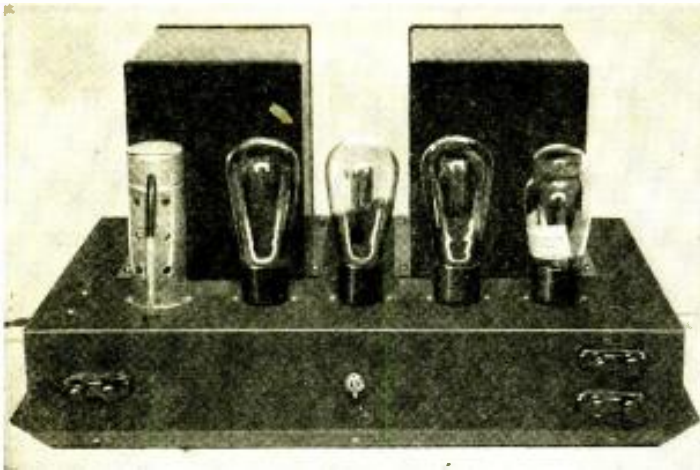

Fig. 4
This multi-switch was designed to replace the buttons in the RADIO-CRAFT analyzer.



Photograph of the new Lafayette amplifier, the circuit diagram of which is shown below.

- ALL Service Men appreciate the value and effectiveness of public address amplifiers for many purposes, but few know just how to go about selling them to live prospects in their own towns. In this article, the first of a series, Mr. Short gives some practical, common sense suggestions, based on his own extensive experience in the field. He has designed, sold and serviced many different types of amplifiers and offers his services to readers of RADIO-CRAFT.

MAKING MONEY

WITH

P.A. AMPLIFIERS

HUBERT L. SHORT*

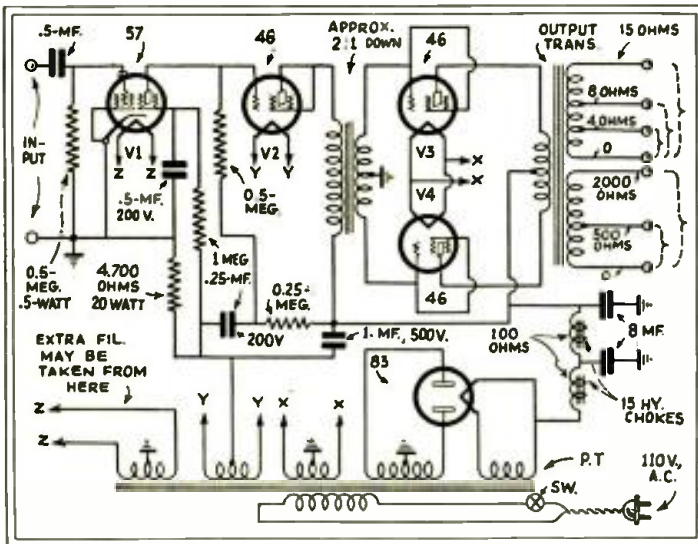

Schematic circuit of the amplifier. Note the use of a 57 direct coupled into a 46, class A amplifier.

TODAY, more than ever before, public address work offers money-making opportunities for wide-awake Service Men who have the gumption to go out after business. Amplifiers and accessories are available in great variety to suit numerous purposes, and their prices have reached levels that were considered impossible only a few years ago. You can quote reasonable figures for even large installations and still make a profit.

The public-address field is the first branch of the radio industry to benefit directly from the recent avalanche of new tubes. While receiver manufacturers actually threw up their hands in despair and pleaded for mercy, P.A. specialists, not hampered by slow acting research departments, swung right into production with amplifiers that took full advantage of the new types. A good example of this quick work is the 28-watt class "B" unit described later in this article.

You must not expect business to fall into your lap without effort on your part. Acquaint yourself with the various public places of your city and consider them all as prospects. Even in very small towns there are many promising possibilities. As prospects for permanent indoor installations of small or large size, jot down the names and addresses of all the local establishments of the following classifications: churches, dance halls, skating rinks, lunch wagons, restaurants, schools, factories, lodge halls and auditoriums.

How to Get Business

Go after the churches first. Because of their very size and architecture, their acoustics are usually pretty bad, and many a good preacher finds himself handicapped by

his inability to make his natural voice heard in the back rows and in the balcony. The use of a P.A. amplifier and a few judiciously placed loudspeakers has increased attendance at more than one house of worship.

Of course you want to make sure that any particular church would benefit by the addition of a P.A. unit. Simply attend yourself and make personal observations on the spot. This is the only way to prepare yourself for any sales campaign. In business, as in war, preliminary preparation is half the battle.

Dance halls and skating rinks, which are the main places of amusement in many towns, are "naturals" for the Service Man. Look up the places that now use only three- or four-piece bands or perhaps a radio receiver that is overloaded beyond the point of respectable quality. Talk to the owners and show how they can make their halls more attractive by playing selected, high-grade phonograph records, made by the most expensive bands in the country, instead of annoying the customers with a sour saxophone or an untuned piano. Tell them how they can stage "radio talent" nights, by getting the local Rudy Vallees and Kate Smiths up in front of a microphone in the middle of the floor. All they can do is say no. Don't be discouraged by the first refusal. Keep after them until they finally threaten you with bodily harm. Very frequently persistence will win out.

Lunch wagons and restaurants in many cases prefer coin operated automatic phonographs to manually controlled amplifiers, but don't pass up any bets. Some of these so-called "lunch wagons" on the more heavily travelled automobile highways are very large and are beautifully and often expensively fitted out, and their patrons rather expect some sort of music without having to push nickels into slots.

Most communities are very proud of their schools and will spend considerable money on them in preference to other municipal undertakings. Therefore by all means approach the school board and present the idea of a public address amplifier for general use throughout the school building or buildings. In many schools a microphone is permanently located on the principal's desk, so that he can make announcements to all classes simultaneously through

(Continued on page 378)

*Sound Engineer, Wholesale Radio Service Co., Inc.

RADIO-CRAFT KINKS

Practical Hints From Experimenters' Private Laboratories

Prize Award

A POCKET RADIO SET

Lawrence B. Johnson

HATS off to the radio set that uses no tuning coil or tuning condenser, but which gets a station just the same!

This arrangement, illustrated in Fig. A, has no selective characteristics but makes it possible for you to enjoy that particular high powered station above all others. This may be seen by reference to the schematic circuit, Fig. 1A. Condenser C in series with the antenna affords a slight degree of selection; one side of the connection to a little wire clip which goes around the threaded portion of the electric light bulb, and the other side of the receiver circuit is grounded, as shown at B in Fig. 1. A crystal detector mounting is arranged inside the headphone as shown at C. The writer will be glad to explain any details which are not clear.

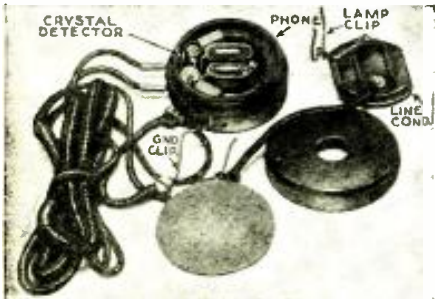

Fig. A
Ah! The "tunerless" receiver at last.

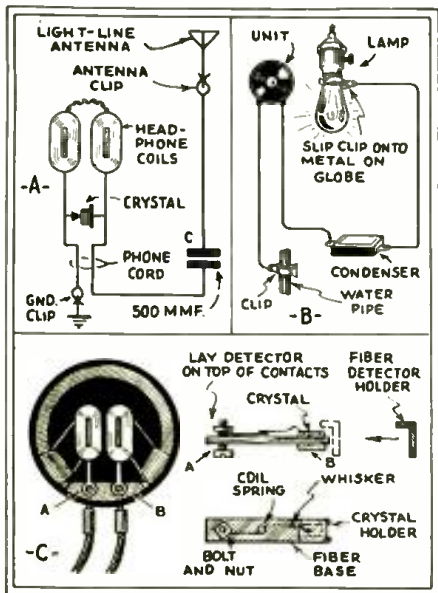

Fig. 1
Detailed schematics of the "tunerless" receiver.

\$5 for a Practical Radio Kink

As an incentive toward obtaining radio hints and experimental short-cuts, "Radio-Craft" will pay \$5.00 for the best one submitted each month. Checks will be mailed upon publication of the article.

The judges are the editors of "Radio-Craft" and their decisions are final. No unused manuscripts are returned.

Follow these simple rules: Write, or preferably type, on one side of the sheet, giving a clear description of the best radio "kink" you know of. Simple sketches in free-hand are satisfactory, as long as they explain the idea. You can send in as many kinks as you wish. Everyone is eligible for the prize except employees of "Radio-Craft" and their families.

This contest closes on the 15th of every month, by which time all the Kinks must be received for the next month.

Send all contributions to Editor, Kinks Department, c/o "Radio-Craft," 98 Park Place, New York City.

BATTERY LUG PLIERS

Walter Luhrs

RADIO men too often resort to the use of a hammer to remove cable lugs which have become corroded to storage battery terminals. However, the special pliers illustrated in Fig. 2 perfectly solve the problem. On an emery wheel, grind to a tapering point the outside faces of a pair of "chain" pliers; this tool may be obtained from an electrical supply house.

A SENSITIVE CRYSTAL SET

J. M. Nighswander

TO date, the writer has picked up the signals of KFI, 750 miles distant, with sufficient strength to hear them in a room 12 x 16 feet, using the receiver which is connected as shown in Fig. 3. On some nights, 12 to 15 Pacific coast stations can be tuned in at my location in Eugene, Oregon. The parts used by the writer are as follows:

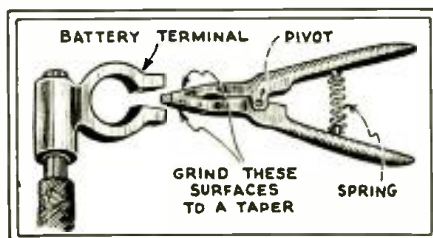

Fig. 2
Truly, an ingenious scheme.

One lump of galena for the crystal detector; one 500 mmf. tuning condenser, C1; one .001-mf. bypass condenser, C2; one coil form 5 x 3 in. in dia., wound with No. 18 D.C.C. wire and tapped as shown, L1; under this coil wind the secondary on a form 2 7/8 in. in dia. The latter winding consists of 11 T. No. 18 enam. wire, spaced one turn; slide this coil, L2, inside the primary, L1; two tap switches complete the assembly.

The range of this receiver is roughly from 126 to 800 meters.

The writer can readily prove the reception claims made for this efficient set.

(Continued on page 377)

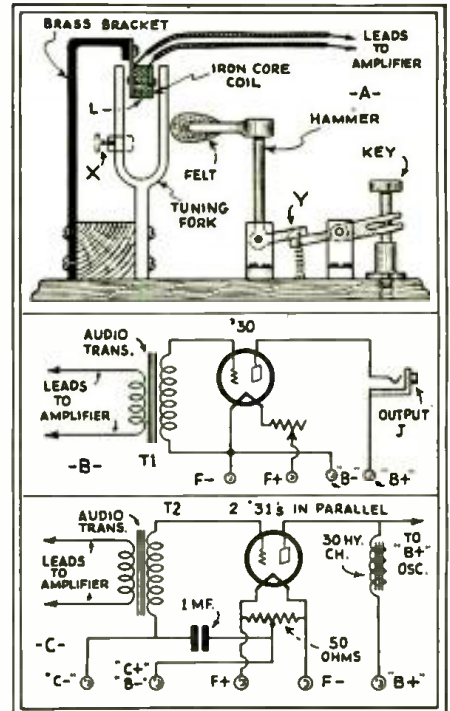

Fig. 4
Here's a real oscillator that should find a berth in any experimenter's lab.

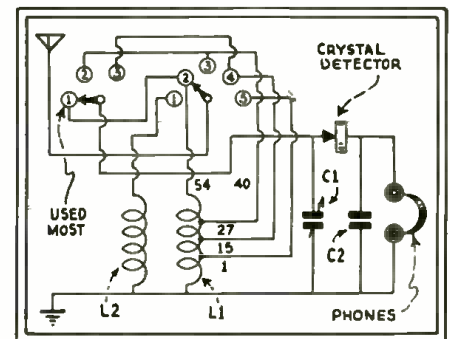

Fig. 3
Well, readers, what do you think of it?

THE RADIO CRAFTSMAN'S PAGE

The Bulletin Board for
Our Experimental Readers

THANK YOU, KIND SIR

Editor, RADIO-CRAFT:

Just opened the November issue of RADIO-CRAFT, and read with a great deal of interest and a lot of hand-clapping your editorial. Go to it! The more truth there is put forward so that people in the industry can read it, the better off we'll all be.

It's too bad the great American public has never learned the lesson that you usually get what you pay for in this world and not a whole lot more, and I agree with you that the Radio business has actually suffered the loss of business on account of the fact that they have not seemed to sense the fact that people are perfectly willing to pay money for something if they get value received.

Again I congratulate you on your editorial!

With best regards, I remain

SAMSON ELECTRIC COMPANY,
R. W. COTTON, SALES MANAGER.

A LA PENTODE PORTABLE

Editor, RADIO-CRAFT:

I am writing you of my experiences with the "A.C.-D.C. Pentode Portable Receiver" described in the September, 1931 issue of RADIO-CRAFT magazine. I am very well satisfied with the results, although I was unable to obtain any reception using the tuning system described in your magazine, probably because of my location.

With a few alterations in the tuning system, I was able to receive stations that other 6, 11, and 12 tube radios could just barely get. I live near the Bingham substation where six, 44,000-volt lines meet at a common bus. My antenna is within 100 feet of this bus! Yet, with my hookup, I am able to bring in Denver, Texas, Los Angeles, and, of course, all local stations.

The sketch of my receiver is shown in Fig. 1. I hope it may be of some use to you or to some of your readers. Referring to the diagram, the parts are described as follows: L1 and L2 are wound on the same form which is 3-inches in diameter; L1 is wound with No. 28 D.C.C. wire and has 30 turns; L2 is wound with the same size wire and has 40 turns. Coil L3 is on a 1¼-inch form and has 10 turns of No. 26 D.C.C. wire. The spacing between the coils is not critical at all. Condenser C has a capacity of .0001-mf.; and C1 and C2 each a capacity of .00035-mf.

IMPORTANT NOTICE

In the interest of those readers who do not like to mutilate this magazine, we have asked our advertisers not to place coupons in their advertisements.

Instead of the usual coupons, you will find a number of convenient post cards inserted between the last page and the back cover of this magazine.

This new service will save you time and work. No need to cut coupons, nor is it necessary to hunt for and address envelopes. Moreover the space for your name on a coupon is usually so small that the advertiser is often not able to make out your writing and then you wonder why you do not get the literature sent for.

Then, last but not least—the postage for a postal card is only 2c whereas a letter now costs 3c.

Read the advertisements and then turn to the page containing the special postal cards. Detach, fill out and mail the card of the advertiser whose literature or offers you want to have sent to you.

Mail your card today! Show the advertisers that you appreciate their cooperation and thoughtfulness.

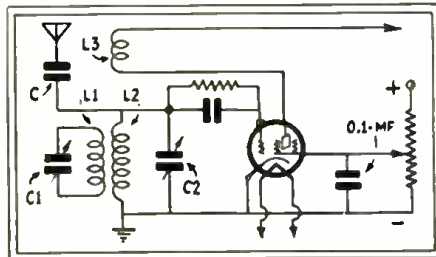

Fig. 1

This gentleman claims wonders for this circuit—we wonder if you wonder.

Hoping that this little sketch will be of some value, I close.

MAX SPENDLOVE,
P. O. Box No. 4,
Bingham Canyon, Utah.

(Thank you Mr. Spendlove. And now readers, suppose you try it and let's know the verdict.—Editor.)

MORE RADIO-CRAFT CIRCUITS

Editor, RADIO-CRAFT:

I was very much interested in that excellent article "Non-Regenerative Amplification," by Mr. Cusick which appeared in the August issue of RADIO-CRAFT. Will you please try and give us another article on the same subject which will emphasize its application to short waves; the I.F. section of supers;

and the changes necessary to accommodate the various types of tubes?

Here's hoping you give us another of your RADIO-CRAFT circuits showing us how to adapt these principles to our own use.

FRANCIS C. WOLVEN,
Route No. 2, Box 103,
Saugerties, N. Y.

(We'll try our best, kind sir, but please remember that we can only run data that we believe will be of general interest.—Editor.)

AH! A COMPLAINT

Editor, RADIO-CRAFT:

I have taken quite a bit of interest in your publication for several past years and today have been reading the September issue. In going over the article by S. H. Burns entitled "How to Build a High Gain T.R.F. Receiver," I find no reference to speakers at all, other than a connection shown on the schematic.

This is true of most designs for both long- and short-wave receivers. Now I would like to know why these articles deal with receivers but pay absolutely no attention to the speakers (or phones) used with them. Is a speaker of no consequence? To me a completed receiver is only as good as its speaker or phones. Why don't the radio industry take a tip from the automobile industry, and learn from its mistakes? Old cars never had a windshield, but today they are being made with spare tires, and even come equipped with complete radio installations!

Other than the above, you have a good magazine.

F. R. GALE,
Balsam, N. C.

(In the first place, most articles treat the procedure to follow in building a receiver—not a speaker. In the second place, a good many of the constructors already have speakers that are perfectly O.K. for the purpose, and the specification of some other make might convince someone of the necessity for purchasing an additional speaker. This is what we wish to avoid—too much expense. In the third place, a completed receiver is *not always* as good as its speaker. Old timers will recall the days of 1922 when a poor receiver with a worse speaker sounded better than the same set with a better speaker—because the better speaker reproduced the *distortions* of the poor set, while the bad speaker did not!—Editor.)

CONSTRUCTING THE TRIPLE-TWIN S. W. RECEIVER

H. HARRISON

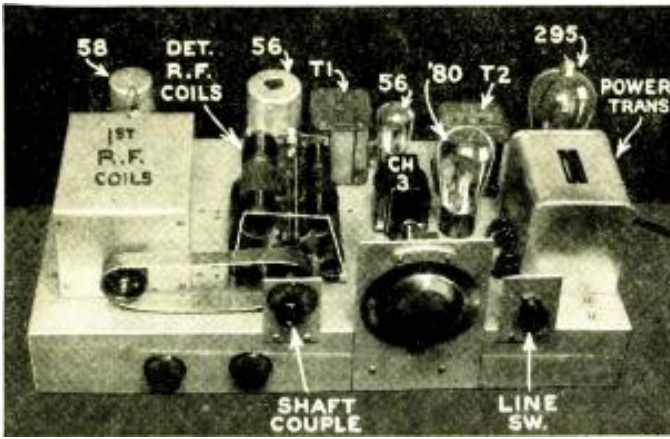

Fig. A
External view of the receiver. All parts are labeled for convenience.

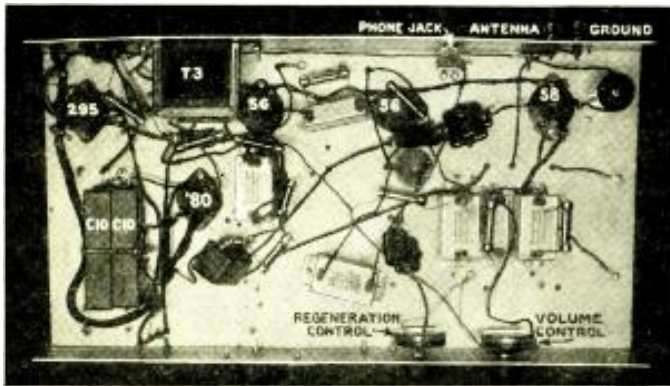

Fig. B
Under-chassis view. The simplicity is evident.

THE general trend of short-wave receivers during the past few years indicates that the barriers against the use of A.C. power supply which prevailed, have slowly, but surely been broken down. Due to the remarkable improvements in present-day tubes and developments in circuit design, the completely A.C. powered, short-wave set may be built with less trouble and greater power output than a battery set. Short-wave manufacturers have been marketing A.C. receivers for the past few years, but the amateur and short-wave fans have been skeptical of their actual worth. The successful performance of A.C. broadcast receivers has altered the outlook toward the use of A.C. for the short-wave receiver.

The numerous objections to A.C. operation may be summed up in one fact—too high a hum level for both phone and speaker reception. Curious as it may seem, A.C. amplifiers are accepted in conjunction with a battery powered set; but full A.C. operation seems to be either a catch-as-can affair, or just a lucky break.

Fortunately, certain mechanical improvements in battery sets are largely responsible for practical A.C. operation. They are: (1) Complete shielding of all coils and tubes in R.F. and detector stages; (2) Adequate bypassing of all power-supply leads; (3) elimination of plug-in coils by the use of fixed coil forms which are gang controlled.

Because of absolute necessity, this set includes these features. Besides these, the greatest gain is secured by taking full advantage of the high voltage necessary for the operation of power amplifying tubes. The receiver embodies an R.F. stage; a regenerative detector, audio and a power audio output stage. The wavelength covered is from 10 to 200 meters by a gang-controlled, four position knob.

The operating features of this receiver are: (1) Low hum level permitting phone and speaker use; (2) single wavelength-change control; (3) single control tuning dial; (4) loudspeaker operation.

The schematic diagram of the set is shown in Fig. 1. The

description of the set will be given by treating each stage as a separate unit.

The R.F. Stage

The tube in this stage is the type 58. The proper operation of an R.F. amplifier preceding a detector should be: (1) No effect on the regeneration action of the detector; (2) no effect on the tuning in the detector stage; (3) this stage must amplify—not “block” the signal.

In effect, the R.F. amplifier must be absolutely isolated from the detector in-so-far as actual detection is concerned. Primarily, all the desirable effects are almost obtained by separate coil and tube shielding. It is far more important to have effective shielding than to worry about the extremely small interstage leads. In this particular receiver, no added gain was obtained by shielding the small interstage leads. Another absolute requisite to the proper amplification of the R.F. tube is the bypassing of all voltage-supply leads. The inclusion of these condensers prevent the flow of R.F. into the voltage supply circuit and also reduce the possibility of hum pickup.

The selection of an R.F. choke proved to be more important than at first thought. The R.F. choke, CH1, has a large effect on the input to the detector stage and therefore must block all R.F. out of the power supply. The combination choke and condenser, CH1 and C5, may be considered as a high-pass filter. The R.F. will flow through the condenser since this is the path of lower reactance. Within limits, the greater the capacity of C5, the greater will be the input to the detector. The ratio between the reactances of CH1 and C5 should be as great as possible, since the larger this ratio, within limits, the greater will be the input to the detector. It can be seen, therefore, that only a short-wave R.F. choke which has a large reactance and small capacity in all the working frequencies can be used.

The coupling condenser C5 is larger than ordinarily recommended, but it is permissible here because of the excellent R.F. choke used.

Tuning is accomplished by the large tuning dial shown in Fig. A. The ganging of both R.F. and detector stages was made possible only by careful construction. The volume is controlled by the potentiometer R12.

The Detector Stage

A type 56 tube is employed as the detector. Regeneration is smoothly controlled by R3. The usual detuning disadvantage of condenser regeneration control is not noticed in this system. The regeneration circuit control consists of a fixed condenser, C4, and the variable resistor R3. Additional amplification is gained by the use of the A.F. transformer, T1. Tetrode detection was tried, but due to the fact that plate- and grid-circuit filters were found necessary in the R.F., the detector and 1st A.F. stage in order to reduce R.F. interstage coupling and to reduce the hum pickup, it was abandoned in favor of the triode.

It must be borne in mind that the coil forms were wound for triodes; a screen-grid detector would necessitate rewinding and adding to the tickler turns. The use of a trans-

A short-wave receiver using the latest tubes available, and one of the most sensitive for short-wave work that has come to our attention for a long time. It is all A.C. operated and has enormous volume.

WHY THIS SET IS DIFFERENT

It is all A.C. operated, thus eliminating troublesome batteries; uses the variable-mu type of tube; reducing interference and noise pickup to a minimum; employs regeneration, which further increases the sensitivity; the triple-twin tube in the power stage results in considerable power output which is perfectly controlled, manually; a tone control—which changes the pitch of the voice or music heard. This device also helps to reduce background noise.

former has the added advantage of reducing the hum. As before, the R.F. choke, CH2, was found to be important. The same type of choke as that used in the R.F. stage was finally selected. Both the R.F. and detector coil forms are ganged and controlled by a single knob.

There are four positions covering the following ranges: 200-80 meters; 80-40 meters; 40-20 meters; 20-10 meters. A small trimmer condenser, C6, provides correct line-up of the dual condenser. This is initially adjusted at about 150 meters. It has been found that no additional adjustments are needed at any other frequency. If the tube does not regenerate, reverse the tickler winding. The new 4-inch National type N dial permits fine tuning.

The A.F. Amplifiers

The '27 is the first A.F. tube; the triple-twin type 295 being the power-output amplifier because of its good frequency response. The operating performance of this tube is such that with a lower input, it will deliver a larger output than the '47. The principle of operation of this tube makes it imperative that the cathode and grid-bias circuits be carefully followed. The choke CH5 should have a minimum value of 20 henries.

To reduce the possibility of distortion and hum pickup, the grid bias resistors must be adequately bypassed. This is especially true for the 295 tube, where a 25 mf. condenser is necessary. The values given for the other bias resistors should be adopted. Headphone reception can be obtained by plugging into the phone jack, mounted on the back of the chassis. The output transformer, T3, may be connected to either a magnetic or dynamic speaker. If a magnetic speaker is used, substitute a 1,500 resistor for the dynamic field, CH4, capable of carrying 125 m.a. Another 30-henry choke may be substituted and a smaller resistor will be necessary. Where a dynamic speaker is on hand,

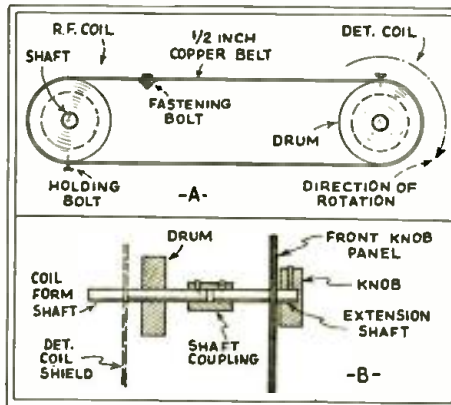

Fig. 2
Detail illustrating the method of coupling the "belt" to the condenser shafts.

be certain that the field resistance does not exceed 1,500 ohms. For coupling to either type speaker, the effective primary impedance of T3 must be 4,000 ohms.

The Power Supply

The rectifier tube may be either an '80 or the new 83 mercury-vapor rectifier. If the 83 is used, it will be necessary to connect a small 3 millihenry, 250 ma. choke at point "X," in Fig. 1. Leaving the choke out of the circuit may introduce a hum.

The care expended in the receiver proper may be completely nullified by a poor filter circuit. Ripple-free D.C. is absolutely essential for operation of the receiver. This can only be obtained

by suitable design of the power supply.

An A.C. hum may be introduced by the power supply by mechanical or electrical faults. Included under the list of mechanical means of producing hum is the magnetic interaction of the A.C. power transformer to the filters or R.F. coils by close physical location, or by vibration of the cores. To overcome these possible and undesirable effects, it is necessary that the components be separated by a suitable distance or that they be shielded from one another. These precautions have been carefully followed. The greatest chance of hum input comes from the filter itself. This filter is a one section pi type. It cuts off at about 40 cycles. This is below the line frequency, and therefore eliminates any hum pickup through the line circuit. Only one filter choke is needed. It has an inductance of 30 henries at a safe current-carrying capacity of 125 ma. The filter condensers, C10, are "dry" electrolytics, having a very low leakage current. The filter parts are mounted beneath the chassis (Fig. B), thus being entirely shielded from the power transformer, although the choke and condensers are not individually shielded.

(Continued on page 373)

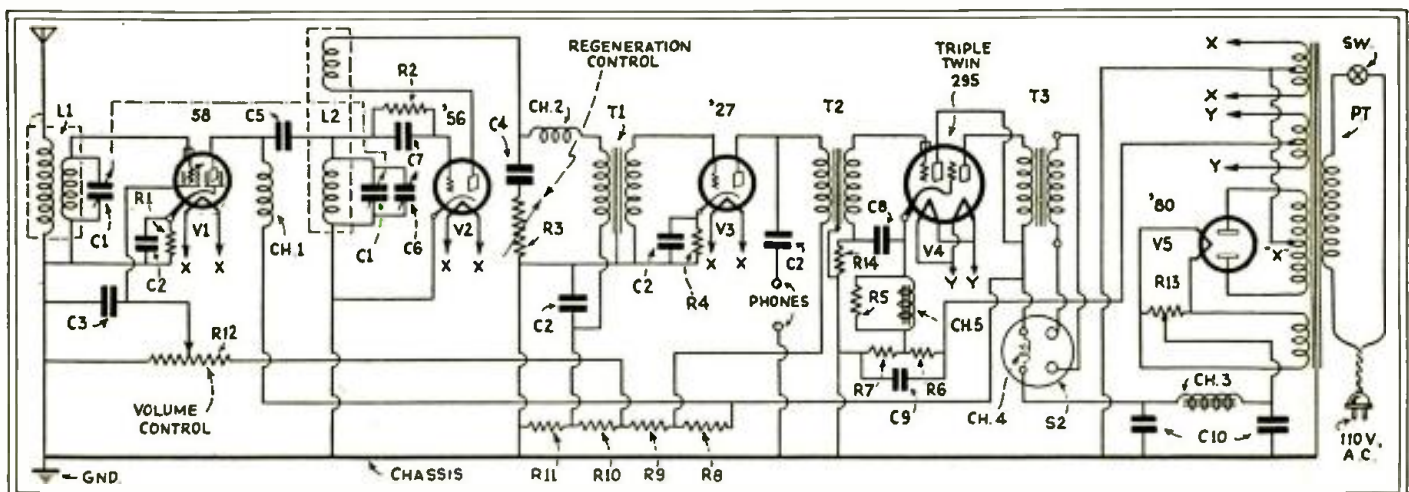

Fig. 1
Complete schematic circuit of the receiver. Refer to the List of Parts for all circuit constants.

RADIO-CRAFT'S INFORMATION BUREAU

SPECIAL NOTICE TO CORRESPONDENTS: Ask as many questions as you like, but please observe these rules:

Furnish sufficient information, and draw a careful diagram when needed, to explain your meaning; use only one side of the paper. List each question.

Those questions which are found to represent the greatest general interest will be published here, to the extent that space permits. At least five weeks must elapse between the receipt of a question

and the appearance of its answer here.

Replies, magazines, etc., cannot be sent C. O. D. Inquiries can be answered by mail only when accompanied by 25 cents (stamps) for each separate question. Other inquiries should be marked "For Publication," to avoid misunderstanding.

BLUE GLOW VS. PURPLE FLUORESCENCE—OSCILLATOR COUPLING

(180) Mr. John Bold, Kansas City, Mo.
(Q.1.) I have a type '47 pentode which shows a purple glow on the bulb. The tube seems to operate satisfactorily, but I understand that this is a sign of possible breakdown in a short time due to ionization. Is this the case?

(A.1.) The following data regarding this phenomena has been released by Sylvania. The effect on the glass bulb of the tube, a purple fluorescence, is not due to the ionization of gases within the tube, but is caused by the impact against the glass of certain of the X-rays generated within the tube itself through chemical reaction between the "getter" and parts of the tube. Gas, on the other hand, manifests its ionized condition as a blue glow around the plate.

Usually, the blue glow of ionized gas at the plate does not change appreciably with changes in the signal volume as does the fluorescence on the glass envelope due to X-rays. As far as we (Sylvania) have been able to determine, the glow which appears on the glass walls of the tube does not in any way affect the tube, or reception conditions.

(Q.2.) Isn't there an error in the diagram of the 3-tube circuit in the article, "The '3-Tube' Autodyne Superheterodyne," in the August, 1932, issue of RADIO-CRAFT, pg. 86? There does not appear to be any coupling between coils L2 and L3 in order to obtain operation of the oscillator portion of the circuit. Isn't there a connection lacking between the B end of L2, and the ground side of coil L3?

(A.2.) The diagram as shown is correct. However, the illustration would have been a little more clear had inductance L3 been shown in inductive relation to L2. It is actually wound on the same tube in order to provide the necessary coupling. As a matter of fact, L3, L2 (both coils) and IFT1 all combine to produce what is termed a "composite oscillator-intermediate."

ER-LA TUBE CHARACTERISTICS

(181) Mr. A. N. Claridge, Baton Rouge, La.
(Q.1.) What are the static and dynamic, and also the distortion characteristics of the Eveready type ER-LA tube?

(A.1.) These figures are given in the article, "More New Tubes," by Louis Martin, in the May, 1932 issue of RADIO-CRAFT, pg. 683. The static figures are represented in more detail in Figs. Q.181A and B, and the dynamic values in Fig. Q.181C; additional figures taken from experimental data are shown in Fig. Q.181D. The distortion characteristics of this type tube are given in Fig. Q.181E.

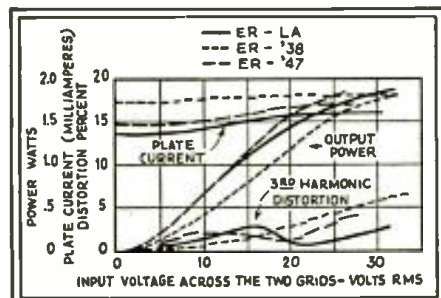

Fig. Q.181A. Characteristic data on the type ER-LA tube described in RADIO-CRAFT.

COPIED PILOT "WASP" SHORT-WAVE RECEIVER

(182) Mr. Eric Svengeld, Lewistown, Ill.
(Q.1.) What is the schematic circuit employed in the Pilot "Wasp" short-wave receiver?

(A.1.) The diagram of connections followed in the "Wasp" receiver are shown in Fig. Q.182A. However, it may be to some advantage if we call attention to other variations of the "Wasp" receiver, diagrams of which have already appeared in RADIO-CRAFT, to wit:

"Super-Wasp," July 1929, pg. 22;
"A. C. Super-Wasp," Jan. 1930, pg. 310;
"Universal Super-Wasp," April, 1931, pg. 604.

The original "Wasp" circuit shown in Fig. Q.182A, bears little resemblance to its ramifications listed above. The A.F. transformers A.F.T.1 and A.F.T.2 may be any desired make; the ratio may be, for instance, about 3.5 to 1. Regeneration is controlled by the two 100-mmf. variable condensers connected in parallel. Note the extremely small capacity of antenna condenser C. The plug-in coils may be those used in the "Super-Wasp" set. It should be noted that many experimenters prefer to use higher values of grid leak resistance, often as high as 8 or 10 megohms; also, the majority seem to prefer to use a grid condenser of 150 mmf. The best value to use for the fringe-howl suppressor, in shunt with the secondary of A.F.T.1, is best determined by experiment.

(Q.2.) In Part I of the article, "Simple Radio Mathematics for the Service Man," by Boris S. Naimark, which appeared in the September, 1930, issue of RADIO-CRAFT was shown a formula for power factor which seems to be in error. Please advise whether this is the case.

(A.2.) A correction of this formula appears in Fig. Q. 182B. The same correction also applies to the reproduction of this series in the book "Radio Questions and Answers," by R. D. Washburne, pg. 59.

$$\text{Cosine } \phi = \frac{R}{Z}, \text{ Sine } \phi = \frac{X}{Z}, \text{ and Tangent } \phi = \frac{X}{R}$$

Fig. Q.182B. A formula correction.

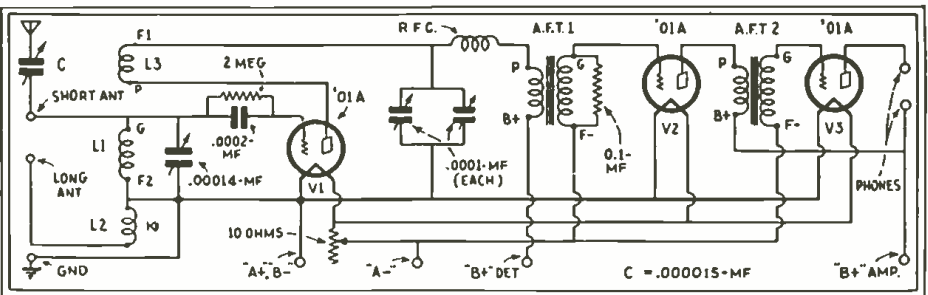

Fig. Q.182A. Schematic circuit of the Pilot "Wasp" short-wave receiver. This is the diagram of a set which in its day, now long past, had no peer. Although type '01A tubes are indicated in the figure, other types of triodes may be tried experimentally.

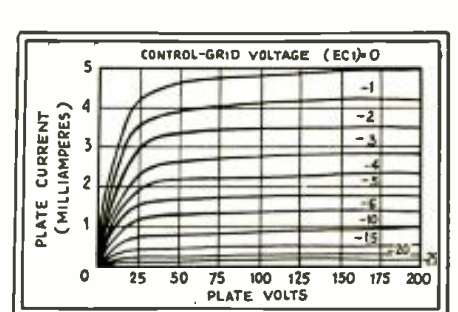
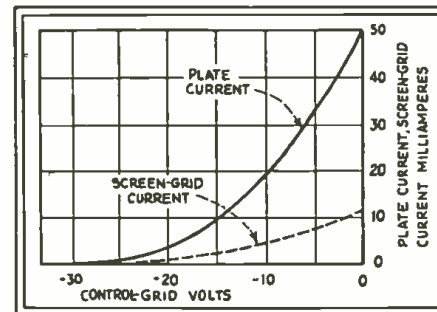
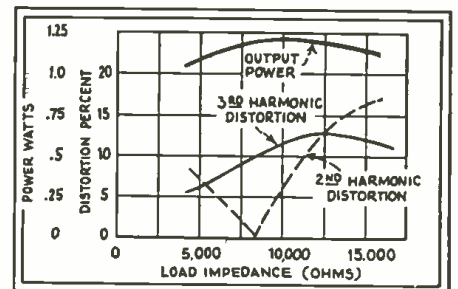
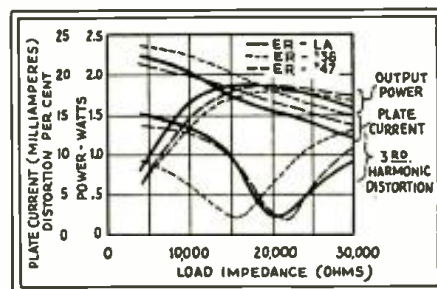

Fig. Q.181B, above, and, Fig. Q.181C, below. Comparative data on Eveready vacuum tubes.

Fig. Q.181D, above, and, Fig. Q.181E, below. Distortion characteristics of the ER-LA tube.

Here comes the



\$5.00

OVER 2,000
ILLUSTRATIONS

OVER 700 PAGES

9 x 12 INCHES

LOOSELEAF
FORM

FLEXIBLE
LEATHERETTE
COVER

1933 Official Radio Service Manual

The importance of the last two OFFICIAL RADIO SERVICE MANUALS to those engaged in the Radio Industry has been shown by the fact that over 52,000 copies of both editions have been purchased and are in use by manufacturers, jobbers, dealers, Service Men and experimenters. Incessant demands have encouraged us to publish a new and bigger *Service Manual* for 1933.

The new manual will not contain so many full-page illustrations as in the past for the reason that not as many new sets are being put out at present, but will have in its contents important information that has not yet appeared in print. This new "dope" is invaluable to radio men. Stress has been emphasized on giving only practical material, not complicated theory. It is bound to save time and money for everyone.

The simplicity in the makeup of the 1933 Manual makes information easy to find, accurately and quickly. As in the past the size will be 9 x 12 inches, in loose-leaf form, with flexible leatherette covers.

Many additional features will be included in the new manual. The FREE QUESTION AND ANSWER SERVICE which was extremely popular in the previous edition will also be maintained. We assure you that the 1933 OFFICIAL RADIO SERVICE MANUAL will be a revelation in radio literature. Advance orders are now being accepted at the price of \$5.00. Take advantage of this low price—send your order today. Be among the early ones to get a copy from the first printing. Checks or money orders accepted—register letter if it contains cash or unused U. S. Postage Stamps.

The following are partial contents of the 1933 Manual:

Complete operating notes, and hints from actual experience with radio receivers in the field, collected by practical Service Men all over the country.

Complete actual, pictorial views of hundreds of commercial receivers with additional schematic diagrams. Location of parts on the chassis are shown, and where important adjustments must be made. This section alone is worth the price of the book.

Values of all intermediate frequencies used in superheterodynes, and a complete section of valuable service data on superheterodynes.

Values of resistors and condensers, to aid in replacement work.

Latest information on combination long- and short-wave receivers, short-wave adapters and converters.

How to tune and service short-wave receivers for best results.

How to use the most modern servicing instruments.

Complete section showing how the Service Man can build himself service instruments, oscillators, etc., at very low cost.

Complete section on the construction of all test equipment, including high- and low-frequency oscillators, tube checkers, ohmmeters, etc.

Tube-chart information on all new and old tubes, in handy form for quick reference; indicating socket connections and operating values, thereby preventing confusion.

An entire section on money-making suggestions for Service Men, written by the Service Men themselves who have made a success of the business; giving you short cuts and commercial information on how to get the most out of the servicing game.

Servicing information on interference elimination, with practical data and many examples of interference prevention.

Automobile radio installation and servicing—hints on automobile radio in general. Complete data on servicing all known, commercial, automobile receivers with short cuts to get quickly at the seat of the trouble.

Service kinks, servicing short cuts, and miscellaneous servicing information.

A complete section of various radio tables of every imaginable kind, in constant use by up-to-date Service Men.

A large section giving complete technical data on meters of every kind pertaining to servicing in general.

Complete index and cross-index to make it easy for you to find almost anything pertaining to service *instantly*.

FREE QUESTION AND ANSWER SERVICE

In every copy of the 1933 Manual, 24 coupons will be found, which will entitle you to 24 thorough and complete answers by mail on servicing and operating on any of the sets or circuits mentioned in the manual, as well as any others not mentioned, for which you might have need. This service alone is worth \$6.00. But it is absolutely free to manual owners.

GERNSBACK PUBLICATIONS, Inc.
96-98 Park Place, New York, N. Y.

I am enclosing herewith my remittance of \$5.00 for which you are to send me one copy of the 1933 OFFICIAL RADIO SERVICE MANUAL at the price of \$5.00 each (checks or money orders accepted). Register letter if it contains cash or unused U. S. postage stamps.

Name
Address
City State RC-12-32

THE OFFICIAL RADIO SERVICE MANUAL
FOR 1933 COMES TO YOU COMPLETE
THIS YEAR—NO SUPPLEMENTS

Make BIGGER PROFITS this year by replacing with ARCO New Life Radio Tubes



Give to your customers the advantage of buying first-quality licensed R.C.A. tubes at prices that are exceptionally low. We carry the largest variety of tubes in the world, many for special purposes, and every tube is replaceable within three months, providing the filament is not burnt out. We either have the tube you require or we will make it for you.

COMPLETE STOCK READY FOR IMMEDIATE SHIPMENT
Order from this page—Remit 20% with order, balance C.O.D. All prices are F.O.B. FACTORY, Newark. Shipments go forward express or parcel post. No order for less than \$5.00 accepted.

TYPE	ANY QUANTITY	
UX-201A	—Amplifier or detector.....	\$0.30
UX-226	—AC amplifier.....	.30
UX-227	—AC amplifier or detector.....	.30
UX-171	—Same characteristics as 171A on tungsten filament, 1/2 amp.....	.30
UX-171A	—Power output amp. for AC or DC operation, 1/4 amp.....	.30
UX-140	—Designed for impedance and resistance coupling.....	.40
UX-120	—Power amp. used in last stage of audio freq.....	.40
UX-199	—Detector and amp. tube, long prongs.....	.40
UV-199	—Standard base, has a 201A base, same characteristics as 199.....	.40
UV-199	—Same characteristics as UX-199 only short prongs.....	.40
UX-112A	—Power amp. tube for low cur. consump., 1/4 amp.....	.40
UX-112	—Power Amp., 1/2 amp.....	.40
UX-200A	—Detector tube recommended for weak signals.....	.40
UY-224	—AC screen grid amplifier.....	.40
UX-245	—Power amplifier.....	.40
UX-201B	—1/2 Amp. Amplifier and Detector.....	.40
UY-246	—Power Amplifier.....	.60
UY-247	—Power Pentode.....	.60
WD-11	—Detector Amp.....	.60
WD-12	—Detector Amp.....	.60
UX-230	—Dry cell amp. and detector, 2 volts.....	.60
UX-231	—Dry cell amp.—last audio stage, 2 volts.....	.60
UX-232	—Dry cell screen grid amp., 2 volts.....	.60
UX-233	—Power Amplifier Pentode, 2 volts.....	.60
UX-234	—Screen Grid Pentode R.F. Amplifier.....	.85
UY-235	—Super control screen grid amp.....	.60
UY-236	—Screen Grid Radio Freq. Amp.....	.85
UY-237	—Detector Amplifier.....	.85
UY-238	—Power Amplifier Pentode.....	.85
UY-239	—DC R.F. Pentode Amplifier.....	.85
UY-551	—Variable Mu.....	.60
41	—Power Pentode.....	.60
55	—Duo Diode Detector.....	.60
56	—A.F. and R.F. Amplifier and Oscillator.....	.60
57	—6 prong Screen Grid R.F. Amplifier and Detector.....	.60
58	—6 prong Variable Mu R.F. Amplifier and Super Detector.....	.60
59	—Power Amplifier.....	.60
85	—Duplex Diode Triode 6 prongs.....	.60
89	—Power Amplifier 6 prongs.....	.60
UX-210	—For power amplifier, high voltage.....	.60
UX-222	—Screen grid radio frequency amp.....	1.10
UX-250	—Power amp. used in last stage of audio freq.....	1.10
Ballast tube to prevent tubes in set from blowing out.....		1.10
Special super-sensitive Audio Freq. 201A.....		1.60
Special super-sensitive Radio Freq. 201A.....		1.60
Special 171 AC 1/2 amp. extra coated filament—good for electric sets.....		.60
T-14 (201A High Mu) high emission tube.....		.60
Switch tube, 201A or 112 or 171 double life.....		.60
Adapter tube 226, 227, 171A, to convert bat. sets to AC, each.....		.60
UY-227A—AC amplifier or detector, same as 227 (but quick heater).....		.60
UY-224A—AC screen grid amplifier, same as 224 (but quick heater).....		.60
RECTIFIER AND CHARGER BULBS		
125 Mil. rectifying tube (B. H.) (Raytheon Type).....		1.25
6/10 amp. trickle charger bulb (Tungar Type).....		2.00
2 amp. old and new type charger bulbs (list \$4.00) (Tungar Type).....		2.00
5 and 6 amp. charger bulbs (list \$8.00) (Tungar Type).....		3.75
15 amp. charger bulbs (Tungar Type).....		7.50
UX-866—Hot Cathode Mercury Vapor Half-Wave Rectifier (Heavy Duty).....		2.75
UX-280M—Hot Cathode Mercury Full-Wave Rectifier same as UX-866.....		1.10
UX-281M—Hot Cathode Mercury Vapor Half-Wave Rectifier.....		1.90
UX-871—Hot Cathode Mercury Vapor Rectifier.....		1.10
UX-280	—Full-Wave Rectifier for High Emission.....	.40
UX-281	—Half-Wave Rectifier.....	1.10
UX-282	—Full-Wave Mercury Vapor Rectifier.....	1.10
UX-283	—Rectifier.....	.85
UX-216B	—Half-Wave Rectifier.....	.85
UX-213B	—Full-Wave Rectifier.....	.85
PHOTO CELLS		
Photoelectric cell, "Potassium" Type O.....		2.10
Photoelectric cell, "Caesium" Type A, 1/4" overall length.....		7.90
Photoelectric cell, "Caesium" Type R, 3 1/16" overall length.....		5.90
TELEVISION TUBES		
Tellon Reflector Neon Television Tube, 1" Cathode Square Type C.....		3.85
Tellon Neon Television Tube, 1 1/2" Cathode Square Type V.....		3.85
Tellon Neon Television tube, 1" Cathode Square Type X.....		2.10
UX-192	—Sparton Type.....	.85
UX-183	—Sparton Type.....	.85
UY-484	—Sparton Type.....	.85
UX-585	—Sparton Type.....	2.10
UY-686	—Sparton Type.....	.85
UX-401	—Kellogg Type.....	1.50
UX-403	—Kellogg Type.....	2.00

UX-280 —Full-Wave Rectifier for High Emission
UX-281 —Half-Wave Rectifier
UX-282 —Full-Wave Mercury Vapor Rectifier
UX-283 —Rectifier
UX-216B —Half-Wave Rectifier
UX-213B —Full-Wave Rectifier

Photoelectric cell, "Potassium" Type O..... 2.10
Photoelectric cell, "Caesium" Type A, 1/4" overall length..... 7.90
Photoelectric cell, "Caesium" Type R, 3 1/16" overall length..... 5.90

TELEVISION TUBES
Tellon Reflector Neon Television Tube, 1" Cathode Square Type C..... 3.85
Tellon Neon Television Tube, 1 1/2" Cathode Square Type V..... 3.85
Tellon Neon Television tube, 1" Cathode Square Type X..... 2.10

UX-192—Sparton Type..... 85
UX-183—Sparton Type..... 85
UY-484—Sparton Type..... 85
UX-585—Sparton Type..... 2.10
UY-686—Sparton Type..... 85
UX-401—Kellogg Type..... 1.50
UX-403—Kellogg Type..... 2.00

ARCO TUBE COMPANY, 40 Park Place, Newark, N. J.

QUASI-OPTICAL EXPERIMENTS

John B. Brennan

THIS is the third of a series of short, simple articles, regularly appearing here. The purpose of them is to describe an easy experiment monthly with apparatus which the ordinary experimenter, engaged in the building and rebuilding of broadcast receivers and associated equipment, has undoubtedly accumulated over a period of years.

Radio, in its popularly accepted sense, is generally regarded as that form of entertainment which is transmitted from the hundreds of transmitting stations scattered all over the world. More specifically, in the United States of America, it is that band of frequencies lying between 545 and 1500 kilocycles (200 to 550 meters)

But actually, this kind of radio, as we have come to know it, forms only a small part of the entire communication service. At the upper end of the frequency spectrum (down in wavelength) there are the short-wave communication services, while at the other end (long waves) are the older, long-wave communication services.

Years ago, more attention, from a communication standpoint was paid to the so-called long-wave transmitters, but now, due to countless experiments, not a few of which are directly traceable to the amateur radio enthusiast, much has been learned of the marvelous carrying powers of the short waves (high frequencies).

Much activity abounds in the amateur, five-meter band. Experiments are daily engaging the attention of engineers in the 1/4-meter band, and so low in wavelength have these experiments gone that now we talk not in terms of wavelength in meters, but in centimeters.

Then, down below that band of wavelengths which have actually been used for communication purposes, there exists that band of frequencies so short in wavelength (high in frequency) that they border on the frequency of light waves. It is because of the borderland character of these waves that they have, for the time being, been termed "quasi-optical" waves, and it will be with experiments in this field that we will be ultimately concerned. Strictly speaking, the experiments described in this department, so far, have not been of the quasi-optical type, but have been presented with a view to acquainting the experimenter with apparatus of a light-sensitive nature which later will lead to experiments more truly confined to the quasi-optical field.

In last month's issue of RADIO-CRAFT, a simple photoelectric-cell amplifier was described and directions given for its construction. It was also explained how this photoelectric-cell amplifier, with its attendant photoelectric-cell, could be used to change variations of light (from a flashlight) into variations of electrical current (as manifested either visually on a milliammeter or in a loudspeaker in the form of sound). The frequency of the sound was dependent upon the number of times the light source was interrupted by some such device as the blades of an electric fan, etc.

Now, in this month's department it will be shown how, with the aid of another piece of apparatus which may readily be built, it is possible to translate the recordings on a

(Continued on page 363)

FREE BONUS OFFER

with every order for \$5.00 of tubes we will give

FREE 2 UY-227 TUBES

For multiples of \$5.00 proportionate amounts of free tubes will be given

Announcing

OUR FALL LINE OF POWER AMPLIFIERS

at the lowest prices in the history of radio

The New P47

with the

NEW '58 TUBES!

NEW CIRCUITS!

TAPPED

OUTPUTS!

HIGHER GAIN!

DOUBLE

PUSH PULL!

Using 2—258; 2—247; 1—280. Tapped output 9-15 ohms for Voice Coil Input. 1000 ohms for AC Speakers. For microphone phone and radio delivers \$13.95

Write for our new price list and technical data. Amplifiers from \$9.85 up.

BLAIR RADIO LABORATORIES
18 Warren Street New York, N. Y.



An Announcement to

SERVICEMEN

We are distributors for the genuine

PHILCO

Replacement units and complete line of parts which are now at your command through

RADIO & ELECTRIC SERVICE COMPANY

N. E. Corner 7th and Arch Sts. Philadelphia, Pa.

Catalogue and prices on request
ORDERS PROMPTLY FILLED

On page 359 of this issue will be found an important announcement of the 1933 OFFICIAL RADIO SERVICE MANUAL. It is worth your while to spend a few minutes reading this advertisement which tells in detail all about the contents of the New Manual.

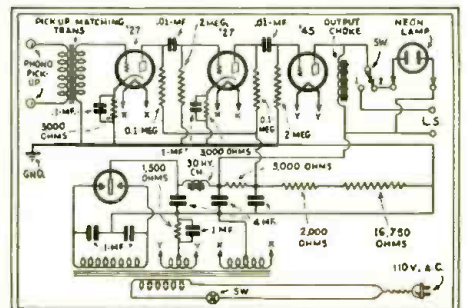

Schematic circuit of the amplifier suggested by Mr. Brennan.

BOOK REVIEW

N. R. I. FUNDAMENTAL RADIO COURSE

The fundamental radio course offered by the National Radio Institute for home study comprises a series of thirty-five booklets of unusual completeness. They start with an elementary explanation of electricity and finish with a description of a typical broadcasting station. The course is of value both to rank beginners and "practical" radio men who just picked up their knowledge haphazardly.

The individual booklets are reviewed herewith:

1 FR: *A Bird's Eye View of Radio*: The elementary basis of radio, which includes the nature of electricity and magnetism; sound and radio waves; the transmission of such waves through space and the elements of radio receivers are discussed to give the student the background of the radio industry.

2 FR: *The Language of Radiotricians*: The language consists of signs, symbols, blue-prints, tables of figures and graphs. In this book the nature of these parts of this silent language is explained by numerous examples.

3 FR: *Practical Radio Circuits*: Beginning with the simplest type of electrical circuit, progress is made toward more advanced circuits, and finally a set of progressively complicated radio circuits is drawn and explained.

4 FR: *How The Radio Receiver is Supplied With Power*: Radio sets need power in order to operate. The various sources of power are described, their principles of operation explained and the various types and uses analyzed.

5 FR: *How Resistors Are Used In Radio to Control Current Flow*: As a means of regulating the current in radio circuits, resistances are very important. The uses of resistances, the various types and how resistances are measured in various radio circuits, are described.

6 FR: *Radio Coils—Why and How They Work*: The second requirement in a radio circuit—inductance—is obtained, as this book will show, by the use of coils of wire. The theory of inductance, the calculation of inductances and their use in radio circuits are described.

7 FR: *Radio Condensers—Their Function and Operation*: The third necessity for a radio circuit, capacity, is obtained by the use of a variety of condensers. The theory and operation of condensers are explained in this book.

8 FR1: *How a Vacuum Tube Works—Types of Vacuum Tubes in Use*: The vacuum tube is the wonder product of the 20th century. In this book the operation of vacuum tubes and their importance to radio operation are discussed for the newcomer to radio.

9 FR1: *Radio Transformers and the Principles of Tuning*: The nature, use and construction of transformers are explained in this book as well as their uses in tuning radio circuits. The method of calculating reactance, impedance and the obtaining of resonance are also explained.

10 FR1: *How A Three-Element Tube Amplifies*: This book returns to a more detailed study of the theory and operation of modern vacuum tubes, their characteristics and how calculations are made on their operation.

11 FR1: *Iron Core A. F. and Power Transformers*: The elements of a magnetic circuit; how iron cores are magnetized and used in transformers; the characteristics of transformers and their application to radio as audio frequency transformers are carefully described in this book.

12 FR1: *How a Two-Element Tube Rectifies A. C. in Power Pack Operation*: The vacuum tube is necessary in a radio circuit as a means of changing alternating to direct current. A detailed study of the vacuum tube as rectifier and some of its ingenious uses and characteristics are explained in this book.

14 FR: *Changing Sound Into Electricity and Electricity Into Sound*: The basis of radio, as well as talking pictures, the telephone, etc., is the conversion of sound energy into electrical energy and vice versa. The nature and peculiarities of sound and its application to microphones and sound reproducers are covered in this book.

15 FR: *The Triode as an Audio Amplifier*: The triode is a three-element vacuum tube; it plays a most important function in radio, talking pictures and telephones as an amplifier. The characteristics, use and importance of audio amplifiers are thoroughly explained.

16 FR: *The Vacuum Tube in Radio Frequency Stages*: The sensitivity of a radio receiver depends upon the radio frequency amplifier tubes.

(Continued on page 376)

It's
VALUE that
TALKS
TODAY!

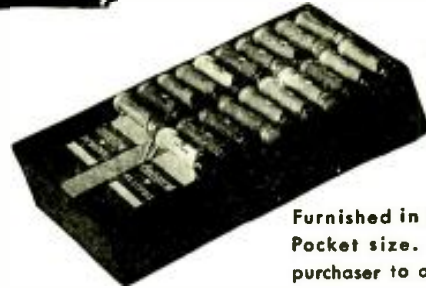

Furnished in two different types. Pocket size. Initial order entitles purchaser to an Ohmhm Resistor

Guide, an Ohm Dial for determining resistance values according to R.M.A. standards, and a supply of attractive service-labels to be placed on back of set after servicing — reminder advertising for the service man.



CHECK RESISTORS for these Cardinal Points:

- Accuracy — resistance value within 10%.
- Permanency—value unchanged by age.
- Absence of noise.
- Low Heat Coefficient.
- Freedom from Capacity Effect.
- Unaffected by Humidity.
- Low Voltage Coefficient.
- Mechanical Strength — ability to withstand rough handling.
- Appearance — straight wire leads, good point finish, etc.

● Color Coded, Printed Values, Trade-Marked.

WHEN YOU use OHIOHM Protect-O-Packed RESISTORS you are assured that they pass the rigid test of all these points—and more! Nationally advertised, supported with profitable merchandising helps, beautifully packaged. Our booklet, "Sales Resistance Removed from the Resistor Market" tells the entire story. Ask for it. It's free.

SPARK SUPPRESSOR SETS for eliminating Ignition Interference on radios installed in Automobiles

Sets are furnished for 4, 6 and 8 cylinder cars. Furnished complete with Condenser and necessary spark suppressors. The life of an Ohiohm Suppressor is the life of the car.

THE OHIO CARBON CO.

12502 Berea Road Cleveland, O.

OHIOHMS are made in Canada by
C. C. Meredith & Co., Ltd., 67 Bay St., Toronto

OHIOHM
PROTECT-O-PACKED
RESISTORS

Something New
for a NEW MARKET!

Cleanaire
ICE-BOX
and REFRIGERATOR

DEODORIZER

- Absorbs and destroys food odors.
- Prevents blending of flavors and tainted foods.

50c
Item
▲ Add this to your line—exceptional profit... Write for facts.
THE OHIO CARBON CO.,
CLEVELAND, OHIO

"Years Ahead,"
Said the Experts.
NOW,
EVEN
BETTER!



RECENT tube developments have made the COMET "All-Wave" (pictured above) and COMET "Pro" (below) Superheterodynes—

even more selective, more sensitive, more stable and easier to tune.

Both receivers now use four "58" tubes, two "57's", one "247" and an "80" rectifier.

The "All-Wave" covers the short-wave and regular broadcast bands, 15 to 550 meters. Console or table model.

The "Pro" globe-trots on the short-waves only—and for proof of unmatched efficiency, here are

SOME USERS

American Airways
Eastern Air Transport Co.
Northwest Airways
American Radio News Service
Canadian Government Signal Service
United States Government, Army and Navy Service
Key Stations of leading broadcasting networks, for foreign reception—and many more of convincing importance.

The "Pro" may now be had in new style metal or wood cabinet. Battery Model also.

Really GREAT receivers—backed by the 30-year-old Hammarlund reputation for doing things right.

Mail
Coupon
for
Folder



COMET

Custom-Built "PRO"

by
HAMMARLUND

HAMMARLUND MFG. CO.
424 W. 33rd St., New York

Please send me illustrated folder, describing the COMET "PRO" and All-Wave Superheterodynes.

Name _____

RC-12

A REMOTE-CONTROL TUNING SYSTEM

(Continued from page 337)

electromagnets from bells or buzzers with their original windings. Both M1 and M2 are fastened to the base with angle irons and connected in series. The armature consists of two lengths of iron about 2 inches long by 1/2-inch wide. These are fastened to a strip of hard rubber about 3 1/2 inches long and approximately 1/2-inch wide. A hole is bored approximately 1 1/2 inches from each end of the strip, and a length of brass tube, 1/4-inch in diameter and 2 inches long, is forced into the holes. A set-screw in the hard rubber holds them in place.

Two spring clips are soldered on each tube and bent as shown in the diagram and photograph. Two lengths of brass rod are mounted by brackets on each end and acts as tracks. Tubing, sliding over these rods, should be a loose fit and not bind. Clips CL2 and CL4 travel the entire length of the blade; but those marked CL1 and CL3 disengage. The sizes and dimensions amount to very little in this piece of apparatus; as it can be seen that when power is applied to M1, the armature is attracted and slides along rods, thus engaging the clips in CL1 and CL3. This provides the circuit for applying power to the driving motor and starting same; while the filaments of the receiver are lighted. Power to M2 causes the armature to reverse its action, and the entire power is cut off. These are actuated by the Circuit Breaker Unit as described above.

The layman may use a flexible cable soldered to the tubing in place of CL2 and CL4; but the spring action of these clips hold the armature in place and prevent closing or opening by vibration or any other causes than by an electromotive force itself.

Tuning Control Unit

This unit consists of a steel shaft 1/4-inch in diameter within a pivot bearing which should swing easily; and should be equipped with a rubber tired pulley. It is located between two, double electromagnets of the buzzer type with their original windings. Fig. 3 shows this unit in full. Two sets of flat-faced pulley wheels are adjusted to rotate easily by the use of adjustable hangers with bearings. The motor drives one set by the use of a chain drive, while other set rotates in the opposite direction due to the crossed belt.

It can be seen that power applied to M1 causes the steel shaft to be attracted, and a rubber-tired pulley to engage the face of the rotating flat-faced pulley, thereby causing the shaft to revolve. And through the various worm and spur gears, cause rotation of the tuning variable condenser in one direction. When the power is released, the rubber tired pulley—by reason of centrifugal action—very quickly disengages itself. Power applied to magnets M2 reverses this action; and due to the rotation of the flat pulley in the opposite direction caused by the cross belt, the shaft now revolves in a clockwise direction. The tuning condenser is operating in reverse.

It will be noted that the grooved pulleys carrying the belt are not of the same size. When the condenser is rotating from the minimum to maximum it is very slow, or vernier, in action. From maximum to minimum, it is very much quicker, but still capable of properly tuning in any station on the return. The reducing gear is of little importance and should have a ratio in the neighborhood of 10 to 1. Slow motion of the tuning condenser is governed mostly by the 16 and 32 pitch worm gears.

The reducing gear is mainly to provide a method by which the pivot shaft can swing easily, and at same time be engaged in mesh without binding. A flexible piece of rubber tubing might answer the purpose and be coupled directly on the worm gear shaft. However, rubber breaks in time and there is always a backlash when it is used.

The pivot bearing holding the shaft is, likewise, of little importance, but it must swing freely. Good types of bearings for this purpose—also for the sliding bearing—are the panel lugs from old telephone jacks. They have a 1/4-inch hold and sufficient stock to permit countersinking slightly for the pivot lugs; and in case of the sliding bearing, to permit a slight groove on the axis to accommodate the Bearing Guide.

This bearing guide is used to prevent "wobulation" in the main, drive shaft.

Magnets should be well fastened to a base-board and a clearance of 1/4-inch between each set and the steel shaft at neutral is maintained. In the "miniature" machine shop, adjustable bearing-hangers were used as they eliminate undue fuss in lining up the shafts to prevent binding. (These shafts, pulleys, worm gears, reducing gears, etc., may be purchased at a very low cost from the PIERCE MODEL WORKS, TINLEY PARK, ILL.)

With regard to the rubber tired engaging pulley, this is a flat type, 1 1/2-inches in diameter, 1/4-inch face. A heavy rubber band was cemented to the face and is an excellent "gripper" upon the flat-face pulleys. The cross belt may be a length of heavy window shade cord (treated with belt compound); a small spiral spring connects the ends. This keeps the belt taut at all times with no slippage.

The sprocket wheel and chain drive may be eliminated and the motor coupled directly to either shaft. This method of tuning-in stations is far superior to the rotating "cam" methods which are limited only to a selected few. The apparatus constructed by the writer successfully tuned in stations from 10 meters to and above the broadcast band.

Regeneration or Volume Control

The regeneration or volume control, shown in Fig. 4, makes use of the "book" type variable condenser; but may be used equally well with the rotary type variable unit. As will be noted in "section A," when power is applied to the magnets, the armature is attracted, and, acting as a "kicker," on one end of the armature, will strike one or more of the teeth on the ratchet wheel. The length of this stroke is governed by the armature stop. By lengthening or shortening—as the case may be—the ratchet wheel may be governed to move from one to five teeth at each "dot." The backlash stop prevents the ratchet from returning or skipping.

Soldered to the armature movable bearing is an arm of very thin, spring brass carrying a contact point; and located directly over this is an angle arm carrying still another contact point. When the armature is attracted, the arm rises and closes contact. This is of no value outside of providing the necessary circuit lead for shutting off all power when set is discontinued. That is: when button No. 3 is pressed with button No. 2, the Motor and Filament Relays will be in operation; but not unless the circuit breaker, shown in Fig. 4, is closed.

The escapement and pin, as shown in "section B" is exactly similar to that used in all alarm clocks. As the pin travels over the surface to a gradual rise, the pin reaches a point where it drops, perpendicular to the bottom of the beginning of the surface rise. The principle used here is identical. As the ratchet wheel reaches the "falling off" point, the shaft and pin drop back to the original position due to the spring action on the movable leaf of the variable condenser. By the aid of the set-screw on all types of book-leaf variables, it is only necessary to adjust this leaf to the near point of regeneration. It will take in the neighborhood of 14 "dots" to bring condenser from the minimum to maximum; and when maximum is reached, to fall back immediately to the before mentioned position near regeneration.

An exact duplicate is made of this apparatus, except that it is not coupled to a condenser. In place, we install a dial or pointer directly on the shaft. The escapement bevel is filed until both escapements on the variable condenser and remote indicator drop in their respective slots at the same time. If it takes 14 "dots" to obtain the identical procedure with both pieces of apparatus, it stands to reason that when the indicator is connected in series with regenerative control, button No. 3 will operate both in phase.

To adapt the principle of regenerative control to the rotary variable, it is only necessary to loosen the bearings on variable unit so the rotor swings very easily, and couple a "pig-tail" connection to the rotor shaft. The escapement tubing, not shaft, is fastened to the rotor shaft of the variable unit in re-

verse. A spring is fastened to the rotor, but not of sufficient tension to retard the forward motion, but to act as a means to return the condenser to minimum from the maximum, or to the near point of regeneration when the pin falls in a slot. A counterweight might be installed on the rotary variable condenser to prevent the rotor from returning with a bang.

Tuning Condenser Indicator

It is not necessary to go into this phase very deeply. Locate on the shaft of the variable a length of hard rubber with a fine piece of spring brass at each end. Fig. 5 shows the "works." When the condenser reaches maximum, a contact is closed that operates a high frequency buzzer. The contact lead of the buzzer "make-and-break" is connected to the remote-control cable running to one leg of the telephone receivers. When the condenser reaches maximum, a high-frequency note will be heard in the receivers, and act as a signal for the operator to let up on button No. 2. Now, when button No. 1 is pressed and held, and the arm comes back to the minimum, another contact is closed, but as will be noted, there is a resistance in series with the buzzer and battery that cuts down the current through it, and produces a low, or raspy, note instead of the previous high pitch. This is the operator's signal that the minimum condenser setting has been reached.

Schematic Diagram

Now that various parts of this apparatus are understood, it is our object to observe the action by manipulation of the buttons. Refer to Fig. 6.

First, we press No. 1 and No. 2. A charge is placed in magnet M4; likewise, the circuit breaker magnets M5 and M6 receive a charge as they are in series with M3 and M4.

The contacts close at each end and provide a path for local current to charge relay magnet M-1. The armature is attracted and clips engage at F4 and F6 from the action of the clip blades CL1 and CL8. One set, CL3 and CL4 start the driving motor, while CL1 and CL2 light filaments.

(Continued on page 374)

HOME EXPERIMENTS

(Continued from page 360)

phonograph disc into variations of electric current; amplify these currents so they will finally be strong enough to actuate the common, television neon tube, which in turn, has its variations in light intensity changed by means of the photoelectric-cell and amplifier described last month, back into sound as it would come directly from the phonograph record.

It is well to reflect for a moment and repeat the somewhat complicated processes involved in ultimately obtaining sound from the record.

On the record are the wiggly spiralled grooves representing stored up sound in the form of music or speech. The phono-magnetic pickup unit changes these vibrations into electric current, which is amplified by the resistance amplifier, and then converted into light variations in the neon photoelectric tube. These light variations are then converted back into electric current by means of the photocell, amplified and finally emitted from the loudspeaker in the form of sound.

If it is desired, the experimenter may attempt to connect the output from the detector tube in a radio receiver to the two terminals formerly connected to the phono pickup and in this rather unusual manner reproduce, through the the neon tube, photocell, etc., the radio program being received.

The diagram for the resistance coupled amplifier is shown here. Its construction need not be elaborate. The values of the parts employed are shown directly on the diagram.

Although no practical, permanent results are obtained from this experiment, since sound from the record can be more directly obtained by substituting a loudspeaker for the neon tube, nevertheless this procedure is described so the experimenter will become familiar with the transference of vibration into the current, then into light, then back to electric current and finally into sound.

Next month . . . confining a beam of light on a target and modulating it by several mechanical means.



ADJUSTABLE SLIDING CLIP

The new fibre guard slips over the TRUVOLT. Protects you and resistor from accidental contact with hands or tools.

BETTER Than Ever!

No other resistors offer so many desirable advantages as the new TRUVOLTS for economical, high-grade service and construction work.

- 1—Patented construction permits larger wire, better electrical contact, longer life and greater radiation.
- 2—Spiral winding and adjustable clips provide finer adjustment.
- 3—Full-length fibre guard (new feature) prevents injury.

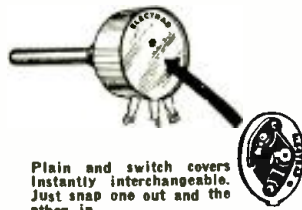

Plain and switch covers instantly interchangeable. Just snap one out and the other in.

VOLUME CONTROLS With Interchangeable Switch

The new ELECTRAD VOLUME CONTROLS are designed for using a power-switch, when desired, without disturbing control connections. Just snap out the standard end cover and replace with power-switch assembly. Long ALUMINUM shafts, also—easy to cut.

The MOST USEFUL "TOOL" In the Service Man's Kit

A HAND BOOK, brimful of resistor values and valuable information on all receivers. Loose leaves. Flexible Fabrikoid cover. Only \$1.00 a year, including four up-to-the-minute supplements. Sold on a 10-day trial, money back guarantee.



\$1.00 a year, with 4 supplements.

Write Dept. RC-12 for Complete New Catalog.

175 Varick St., New York, N.Y. **ELECTRAD**

Cash in on Newest and Most Practical Method of Set Testing!



MAKE more money with this new, more practical tester. It will enable you to quickly and precisely make a complete analysis of the set circuit from the set socket—including resistances, continuities, capacities and short circuits—without removing chassis from the cabinet.

Readrite

NO. 1000 TESTER
\$33.00 Net to Dealer
\$55.00 List

When you use the No. 1000 Tester, to analyze set circuits, your work is made easier by its exclusive method of operation, which embodies the use of two plugs and cables. One of these plugs goes into the tube socket and is connected with the distribution circuit of the set. The resistance is then measured between the two sockets in which the plugs are inserted—making possible a quicker, more precise analysis of the various parts of the circuits in this manner.

Only by resistance testing can you easily and properly with No. 1000 Tester do the following work: Class B Amplification, Muting

Circuits; Testing Diodes; Automatic Volume Control Testing; Resistance Coupling, etc.

If your jobber cannot supply you, we will ship the No. 1000 Tester directly to you . . . when remittance accompanies your order at dealer's net price of \$33.00.

Mail this Coupon NOW!

READRITE METER WORKS,
17 COLLEGE AVE.,
BLUFFTON, OHIO.
Gentlemen:
Please send me information about Readrite No. 1000 Resistance, Continuity and Capacity Tester. Also catalog of other servicing instruments.

Name

Street Address

City State

READRITE METER WORKS
17 College Ave. Bluffton, Ohio

Practical Radio Engineering

An opportunity for **RADIO MEN** to enlarge their scope of training



NEW GENERAL COURSE IN RADIO combines Broadcasting . . . Sound Motion Pictures . . . Aircraft Radio . . . Marine Radio . . . Radio Servicing . . . Home and Studio Recording . . . Television Fundamentals . . . Electronic Tube Applications . . . Radio Code . . . Public Address Systems . . . and other radio and allied subjects.

In a 52-Week General Course at The New York School

At a moderate cost which may be paid \$10 weekly until tuition fee is completed. A graduate of this course is well fitted to handle practical radio engineering problems.

No matter how much or how little knowledge of radio you have, there is a distinct advantage in taking this course. Further details will prove it.

If you wish to specialize in a particular phase of radio or associated arts, send for a copy of our illustrated catalog which contains all particulars about RCA Institutes' various Resident School Courses.

Visit our RCA Institute School in New York or Chicago. You will find them modern, fully-equipped, and ample in scope for the ever-growing field of radio. We shall be glad to see you at any time of day—morning, afternoon or evening—on Mondays to Fridays inclusive.

Whether you plan a visit to us, wish to enroll for a resident school class, or merely wish a free copy of the new RCA Institutes catalog, fill in and mail the coupon below.

RCA INSTITUTES, Inc., Dept. RT-12
New York School and Headquarters,
75 Varick Street, New York, N. Y.
Chicago School:
1154 Merchandise Mart, Chicago, Ill.

Please send with no obligation to me:
() Full information on the New General Course in Radio. (At New York resident school only.)
() Illustrated catalog and information about specialized resident school courses in radio and allied arts.
() Information about extension courses for study at home, together with illustrated catalog.

Name..... Age.....
Address.....
City..... State.....

MIDGETS

Mr. Serviceman and Dealer

4 Tube 2 Circuit with tubes.....\$11.00
5 Tube 3 Circuit with tubes..... 13.00
5 Tube Super with tubes..... 15.50
5 Tube Auto-Radio with tubes..... 16.00
(Everything Except Batteries)

Regular 90 day guarantee including tubes

TRUMAN RADIO SHOP
7443-C Stewart Ave. Chicago, Ill.

BATTERY-OPERATED P.A. SYSTEM

(Continued from page 331)

have a neat job (especially where the hole is cut in the side for the speaker opening). Use white wood and follow the specifications as given. The box may be stained any color (dark oak is very serviceable). Remember, this case must carry the weight of the batteries, so it should be put together very strongly.

Fasten the handle to the top of the case with 8-32 machine screws and use washers under the nuts so the wood is not weakened by the weight of the completed unit.

The front and rear sides are held in place by the small hooks at the top; at the bottom there are two brackets with holes which, with the aid of 6-32 machine screws, form a catch-and-guide holder for the bottom of the removable sides.

Iron is used for the amplifier chassis and should be drilled and folded as shown in Fig. 2 and Figs. B and C. There is nothing difficult or new about this chassis, but if the builder wants to obtain the chassis ready-made with all holes drilled as per specifications, he may do so. Follow all dimensions carefully, as the leads from the audio-frequency transformers come out of the bottom of their respective cans, and if the holes are not right, the leads may short to the chassis.

Amplifier Assembly

Start the assembly of the amplifier by mounting the sockets and audio-frequency transformers Nos. 16 and 19 on top of the chassis; mount the input and output terminal strips on the ends of the chassis; the input strip to the left, and the output strip to the right.

Wire the filament, plate, and grid connections and after this is finished connect the 4 mf. bypass condenser which is mounted on the wall of the chassis. The input transformer, T, fastens alongside the 4 mf. unit near the input strip. It might be well to cover the flexible leads of the input transformer with varnished tubing so there will be no short circuits in the input circuit to the grid of the first tube. The secondary has a center-tap connection for use as a push-pull input transformer. Use the two outside wires and be sure that the center tap does not ground. This amplifier should be wired with the idea in mind that no matter what happens, wires must not come loose—solder accordingly.

It will be noted that the assembly and wiring operations are more or less interlinked. This is due to the fact that the amplifier has been made as compact as possible. By wiring the filament and plate leads before completing the assembly, the builder will save lots of trouble and time.

Final Assembly

After the case hardware has been placed in position and the speaker mounted on the side, obtain some strap iron about 1-inch in width and bend it into shape as shown in the photographs. These straps are necessary to hold the batteries in place when transporting the unit from place to place. Mount the "C" battery with its mounting bracket in the upper, right-hand side of the box. Place all of the batteries in their proper position and wire them, holding the various wires in place with insulated staples driven into the wooden case. Bolt the amplifier to the chassis in the same manner that was used to hold the sides of the box in place. This permits the easy removal whenever connections to the input or the output terminals must be made.

If the builder desires to have the speaker placed some distance from the amplifier, then the cable running from the output terminal strip must be made longer. In general, do not make this line over 40 feet long and use a wire with as large a diameter as possible—nothing smaller than No. 18.

Operation

After the various units have been assembled, connect the "mike" to the input terminals using terminals marked M and MC for a single button mike, and terminals M, MC and M for two button types. If the phonograph pickup is to be connected, use the terminals marked P.P.

\$5,000 WILL BE PAID TO ANYONE WHO PROVES THAT THIS IS

not the actual photo of myself showing my superb physique and how the Ross System has increased my own height to 6 ft. 3 3/4 inches. Hundreds of Testimonials. Clients up to 45 years old gain from 1 to 6 inches in a few weeks. **No Appliances—No Drugs—No Dieting. ROSS SYSTEM NEVER FAILS. Fee Ten Dollars Complete. Convincing Testimony and Particulars 5 cent stamp.** "Allow time for return mails across the Atlantic."

G. MALCOLM ROSS, Height Specialist.
Scarborough, England. (P. O. Box 15).

Knowledge Pays Big

We teach you how to build and operate Radio Treasure Finders and how to locate Metals Underground, Fascinating, Scientific, Accurate. Full details for 3c stamp—Write TODAY.

Exchange, P. O. Box 607-W El Monte, Calif.

TAU-REX CONVERTS

Any D. C. Milliammeter into a Sensitive A. C. Meter. A New Copper-Oxide Rectifier—MADE FOR METERS—Size 3/4 in. by 5/8 in. FULLY GUARANTEED.

Can be used in set testers, analyzers and for many other purposes. See Jack Grand's article, "The Specialty Tester" in the November issue of Radio-Craft.

Tau-Rex will be shipped postpaid promptly upon receipt of \$3 (check or money order)—or order C. O. D. and pay postman. Furnished Complete with Diagrams and Instructions.

Leo Taussig, 3245 37th St., Long Island City, N. Y.

RADIO SCHOOL

Courses in Radio Broadcasting, Wireless Operating, Radio Servicing and Electric Refrigeration. Address

J. C. VAN HORN

(Formerly Vice-President RCA Institutes, Inc.)

PHILA. WIRELESS SCHOOL
1533 Pine Street Philadelphia, Penna.

PATENTS—TRADE MARKS

All cases submitted given personal attention by members of the firm.

Information and booklet free

LANCASTER, ALLWINE & ROMMEL

PATENT LAW OFFICES

Suite 436

815—15th St., N. W. Washington, D. C.

A REAL ANALYZER CONVERTER

that brings your analyzer up-to-date. Enables you to test all types of 4, 5, 6 and even future 7-prong tubes. Shoots trouble by new resistance-test method without removing set from cabinet.

No. 477 kit of parts, including No. Aid parts listed at \$10.35, drilled and engraved (8 characters) panel, cabinet, etc., \$9.95. Completely wired and tested, \$11.95.

No. 478 Senior model using 7 switches. Kit of parts (30 engraved character), \$11.75. Completely wired and tested, \$13.95.

Analyzers rebuilt for modern servicing.

Write for prices.

SOL PERLMAN, E. E., 647 East 96th Street
BROOKLYN, N. Y.

The better the "mike" the more satisfactory will be the results. Double button "mikes" are to be preferred because of their better frequency response. *Microphone current is fixed by the voltage of the single dry cell and this should not be exceeded.*

The best location of the speaker in respect to the mike must be found from experience. In general, keep the microphone as far as possible from the speaker, as there is considerable gain in the amplifier and a strong tendency for acoustic feed-back is present. When the system is used out of doors, this feed-back tendency is more or less reduced. The volume is controlled by the potentiometer mounted on the top of the case. A built-in switch on this control turns the filament voltage on and off in the zero gain position.

List of Parts

One Acratest input terminal strip No. 7148. (1), (2), (3), (4), (5), (6);
One Acratest input transformer No. 2567, (7);
One Frost volume control and switch, 80 series, 500,000 ohms (8) and (27);
One four-prong wafer socket, (9);
One Acratest carbon resistor, 20,000 ohms, 1 watt, (10);
One Acratest carbon resistor, 75,000 ohms, 1 watt, (11);
One Acratest carbon resistor, 125,000 ohms, 1 watt, (12).

(Continued on page 378)

ADAPTERS FOR TEST EQUIPMENT

(Continued from page 347)

No. 975, Fig. 18, is for tube tests on PZ, '33, 46 and '47 tubes; used with models 533, 555 and 565 testers.

No. 955G, Fig. 69, is to be inserted in the UY socket of the model 533 tester.

No. 954WE, Fig. 70, is attached to the test plug or 5-prong adapter for testing the Western Electric 205D tube; used with models 565, 566, 589, 593 and 660 testers.

No. 979WE, Fig. 57, is placed in the UY socket of the tester to test the 205D tubes. Used with 537, 547, 565, 566, 589, 593 and 660 testers.

No. 944WE, Fig. 71, is attached to the test plug of models 537 and 547 testers to test the 205D tube.

No. 999, Fig. 39, is attached to the test plug so it may be placed in UV199 sockets; used with models 519, 537, 547, 565, 566, 589, 593 and 660 testers.

No. 429, Fig. 40, is placed in the UX socket of the tester to accommodate the UV199 tube; used with all models described for the No. 999.

No. 419X, Fig. 42, is attached to test plugs so it will fit in large UV sockets; may be used with models 519, 537, 547, 565, 566, 589, 593 and 660 testers.

No. 982, Fig. 12, is used with models 533, 555, 565, 593 and 597 testers to check the 82 tube in the '45 socket and the 83 tube in the '71 socket.

No. 965DW is used with models 547, 565, 566, 589, 593 testers and is used for the same purpose as described for Fig. 8.

No. 965KS, Fig. 16, is used to test the 57 and 58 tubes in models 555, 593 and 597 testers. The adapter is placed in the '24 socket.

No. 955G-2, Fig. 17, test the G-2 tube in models 533, 555, 565, 593 and 597 testers.

No. 949K, Fig. 4, tests the Kellogg tube circuits. It is attached to tester plug; used with models 537, 547, 565, 566, 589, 593 and 660 testers.

No. 944LS, Fig. 44, is the companion to the No. 949K. It is to be placed in tester socket.

No. 967, Fig. 43, is the large UV-to-UX adapter. It is to be placed in tester socket; used with models 519, 526, 533, 537, 547, 555, 565, 566, 589, 593 and 597 testers.

No. 944JY, Fig. 13, is used with models 533 and 565 testers to test the 2nd plate of the '80 rectifier.

No. 964DS, Fig. 10, makes a 4-prong test plug from the 6-prong plug of model 660 tester.

No. 944G, Fig. 72, is used to test the '22 and '32 tubes in models 533, 555, and 593 testers. Place a No. 944G adapter in a UX socket, the tube in a No. 944G adapter and make the control-grid connection. This adapter checks the 865 tube in models 533, 555, 565 and 593 testers.

No. 965CG, Fig. 14, used with models 555, 593, 597 testers to test the 41, 42, PA and PZH tubes.

No. 952J may be used with all Weston testers. Same as described for Fig. 3.

No. 949PT may be used with Weston oscillators and output meters. Same as described for Fig. 19.

No. 954KGL, Fig. 22, is used to test the first section of 93 and 95 tubes; used with models 533, 555 and 565, 593 and 597 testers.

No. 954KG, Fig. 23, tests the second half of 93 and 95 tubes.

No. 944PLCR is for testing the 866 tube in tube checkers. Used with models 533, 555, 565, 593 and 597 testers. Same as described for Fig. 24.

No. 955GGKI tests the 5-prong Wunderlich tube in the '27 socket of 533, 555, 593 and 597 testers. Same as described for Fig. 48.

No. 965GG is for testing 29 and 69 tubes in models 533, 555, 565, 593 and 597 testers. Same as described for Fig. 28.

No. 944BRK, Fig. 29, is used to test the Raytheon Auto Eliminator BR tube. May be used with models 533, 555, 565, 593 and 597 testers.

No. 944BRA is used with the No. 944BRB adapter to test the circuits of the BR tube; used with models 537, 547, 565, 566, 589, 593 and 660 testers. Same as described for Fig. 30.

No. 944BRB, Fig. 31, is placed in the UX socket of any analyzer to test the circuits of the BR tube. This adapter is used in conjunction with the No. 944BRA adapter.

No. 944BHR tests the Raytheon BA and BH tubes in models 533, 555, 565, 593 and 597 testers. Same as described for Fig. 32.

No. 955KPT provides connections for an output meter across a pentode; used with Weston output meters. Same as described for Fig. 33.

No. 955SPT, Fig. 34, same as for the No. 955KPT adapter except for a triple-twin tube.

No. 975KP tests the 7-prong tube in models 533, 555, 565, 593 and 597 testers. Same as described for Fig. 35.

No. 950HS is the combination adapter having four sockets for testing the 29, 69, 41, 42, 57, 58 and 82 tubes. It later will also be available with a 7-hole socket. Same as described for Fig. 36.

Adapters for Supreme Testers

No. 994F, Fig. 73, is used with models 99A and 99A+, 400A, 400A+, 400B and 400B-3 testers for synchronizing purposes. It permits the connection of a meter in series with the plate circuit.

No. 429, Fig. 40, is used with all Supreme testers. Its purpose is to permit the insertion of a UV199 tube in the UX socket of tester.

No. 967, Fig. 43, is similar to the No. 429 adapter except that it is used for large UV tubes such as the '00A, '01A, etc.

No. 954U, Fig. 74, fits the 5-prong plug of 99A and 400A changing it to a 4-prong plug.

No. 954, Fig. 58, is similar to the No. 954U adapter with the exception that the cathode is connected to the negative filament.

No. 949K, Fig. 4, used with models 99, 99A+, 400A and 400A+ testers to test overhead Kellogg tubes. It is to be attached to the plug.

No. 944LS, Fig. 44, is similar to the No. 949K adapter except it fits the socket of the tester.

No. 944N, Fig. 75, is used in connection with all Supreme testers and any others having an oscillator. Its purpose is to take the place of the tube when neutralizing.

No. 955N, Fig. 76, is the same as the No. 944N adapter except it is made for 5-prong tubes.

No. 944JY is the same as described for Fig. 13; used with the model 17, and all others not having a milliammeter in the grid circuit.

No. 955, Fig. 77, is merely a 5-prong extension for 5-hole sockets where it is difficult to get the plug; may be used with all models.

No. 999 may be used with all models. Same as described for Fig. 39.

No. 977, Fig. 78, attaches to the test plug of models 90-1J and 2J series and 400B-N4 series for pentode testing.

No. 976, Fig. 79, is similar to the No. 977 adapter except that it fits the socket of the tester.

No. 975, Fig. 18, is for testing the 33, 46, 47, PZ and GA tubes. Use '27 socket of tester. Used with the models 400B and 19 testers.

No. 965SL, Fig. 80, is used with the models 90-1-2-3-4 and 5J, and AAA1 testers for testing the circuits of 57 and 58 tubes. It is to be inserted in the 5-hole socket of the tester; it is used with either 946DS2H, 946SS, or 956SS adapters.

No. 965KS, Fig. 16, is for testing the 57 and 58 tubes in the models 19, 40 and AAA1 testers. Insert in 5-hole socket.

No. 955SG2 is for testing the G-2 tube in the models 19, 40, 100 series and AAA1 testers. Same as Fig. 81 except different value of resistor is used.

No. 965PG, Fig. 25, tests the 41, 42, PA and PZH tubes in a '37 socket. Used with 400 series.

No. 965-55 tests the 55 and 85 duplex-diode triode tubes. Used with the models 17, 19, 40, 99 series, 400 series and AAA1 testers. Same as described for Fig. 26.

No. 955GGKI tests the Wunderlich 5-prong tube in '27 sockets. Same as described for Fig. 48.

(Continued on page 375)

Popularly Priced!

Acratone AMPLIFIERS

4 WATTS

Cat. No. 120

\$12⁷⁵

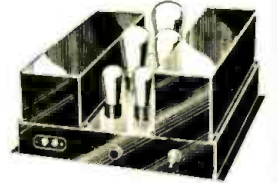

THREE STAGE PUSH-PULL 245—Uses: 2-56's, 2-45's and 1-80, 14" long, 10" wide, 8" tall. Shipping weight 35 lbs. Set of Universal Tubes \$2.25.



6 WATTS

Cat. No. 107

\$18⁵⁰

Shipping Wt. 40 lbs.

SEMI-CLASS B PUSH-PULL 247—Uses: 2-57's, 2-47's and 1-80, 11½" long, 6½" wide, 7" high. Set of Universal Tubes \$2.60.

11 WATTS

Cat. No. 101

\$24⁵⁰

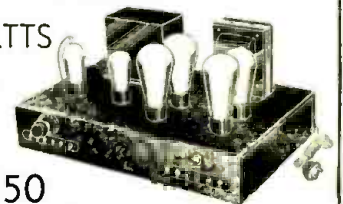

THREE STAGE "250"—Uses: 1-58, 1-56, 2-250 and 2-281, 16" long, 11" wide, 8" high. Shipping weight 50 lbs. Set of Universal Tubes \$6.25.

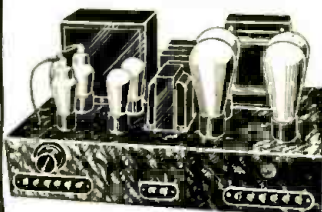

30 WATTS

Cat. No. 125

\$37⁵⁰

CLASS "A" PRIME, TRIPLE PUSH-PULL—Uses: 2-57's, 2-56's, 2-80's and 2-81's, 16" long, 11" wide, 8" high. Shipping weight 60 lbs. Set of Universal Tubes \$8.00.

ALL ACRATONE AMPLIFIERS have the exclusive feature of brooding for the use of high and low impedance input or output, with use with single or double button mikes and low or high impedance pick-ups.

The above amplifiers fully described in our 108 page catalog listing over 3000 items at lowest prices in radio history. Send for your FREE copy to-day.

SPECIAL CLASS "B" TRANSFORMERS FOR BATTERY OPERATED PORTABLE AMPLIFIER

Special Input. Cat. No. 7145, \$1.75. Class B Coupling Transformer. Cat. No. 7127, \$1.95. All-impedance Out-put Transformer, Cat. No. 7128, \$2.95.

Federated Purchaser Inc.

Main Office and Warehouse
25 Park Place, Dept. G, New York, N. Y.

Above merchandise may also be purchased at our following branches:

92-26 Merrick Road, Jamaica, L. I.
51 East 3rd St., Mount Vernon, N. Y.
2909 No. Broad St., Philadelphia, Pa.
273 Central Ave., Newark, N. J.
631 Spring St., N.W., Atlanta, Ga.

Your Copy is Ready



Service Men—
Write for your
FREE Copy
of our 1933
Radio Catalog

LOWEST WHOLESALE PRICES

80 Pages of everything you need in Radio. Complete stocks of the highest quality replacement parts, tubes, test equipment, and accessories at the lowest wholesale prices.

UP-TO-THE-MINUTE SERVICE

Our tremendous stocks and efficient organization are waiting to serve you promptly, courteously, and efficiently.

Write today for your FREE COPY of our 1933 Service Men's Radio Catalog.

ALLIED RADIO CORPORATION

835 W. Jackson Blvd. Chicago



Insure
YOUR WORK

with

CLAROSTAT
Replacement
VOLUME CONTROLS

CLAROSTAT Replacement Volume Controls are "Custom-Made" to exactly suit the receivers for which they are offered. Not a makeshift job lot idea.

The resistance, taper, shape and shaft are made according to the proper specifications. There is no delay in installing them. There are no comebacks when you use CLAROSTAT products. See the new CLAROSTAT CONTROL HANDBOOK AND CATALOG for 32 pages of dope for service men. Send for your FREE copy.

CLAROSTAT Mfg. Co.
285-287 N. 6TH ST. BKLYN. N.Y.

FLEETWOOD SALES CO.

16 Hudson St., New York City

Specialist in Dial-Cables, Belts and Bands
For all Radio Sets

Also Complete Line of Radio Parts

Servicemen—Jobbers and Dealers. Write for Prices
Special R.M.A. 1-watt Carbon Resistors \$1 per doz.

Autocrat Auto Radio **\$17.45**

6 TUBE
175 to 550 Meters

Complete less
"B" Batteries
Net to Dealers

Complete accessories include mounting brackets, illuminated dial, lock switch, remote control, dynamic speaker, 6 RCA (Lisc.) Tubes, spark suppressors, and antenna. Everything except "B" Batteries. Small and compact 5 1/2" x 6 1/2" x 8 3/4". Distance range 100 to 1000 miles. Send \$3.00 deposit. Balance C. O. D.

AUTOCRAT RADIO CO.,
3857 N. Hamilton Ave. Chicago, Ill.

D.C. KIT SET

(Continued from page 339)

enam. wire wound on a tube 1 in. in dia. At the factory the inductance of these secondaries is accurately balanced for zero-beat in an oscillator test-circuit, a bakelite finger moving the wire 1/8-in., a turn at a time, until a meter gives the correct indication.

Each rotator section of the tuning condenser gang is equipped with two end-plates with adjustable segments; these provisions for alignment are independent of the usual trimmers, which furnish control of the minimum capacity in each section.

Two wires along one side of the tuning condenser gang eliminate circuit oscillation due to stray fields. These wires appear in Fig. A.

The antenna lead is separately shielded inside the chassis to prevent circuit oscillation due to over-all coupling. Dual isolation is obtained through the use of condensers C9, C10; the possibility of grounds is further reduced by the use of long leads for the antenna and ground instead of the more common binding posts; the negative lead of the power line connects directly to the chassis, as indicated in the schematic circuit, Fig. 1.

Resistor R11 operates as an R.F. grid suppressor; it is bypassed by the capacity of the preceding tube, V4. A terminal strip is provided on the rear skirt of the chassis for connecting a phonograph pickup into circuit.

The author will be glad to advise further concerning this kit-set or the completely wired and tested instrument. Just enclose a stamped, return-addressed envelope.

List of Parts

- One DeJur-Amsco 4-gang variable condenser, 360 mmf., with trimmers, C1, C2, C3, C4;
- One Savil Type 748 special shielded R.F. coil kit (see text for description), L1 to L4;
- One Micamold fixed condenser, 250 mmf., C9;
- Nine Cosmic fixed condensers, 0.1-mf., C10 to C18, and C23;
- One Micamold 100 mmf. fixed condenser, C19;
- One Cosmic fixed condenser, .01-mf., C20;
- One Cosmic fixed condenser, 0.5-mf., C21;
- One Cosmic fixed condenser, .05-mf., C22;
- One Solar non-polarized dry electrolytic condenser, C24;
- One Centralab volume control potentiometer, min. resis. 175 ohms, total 10,000 ohms, R1;
- One Centralab tone control, 0-1/4-meg., R2;
- One I.R.C. Durham carbon resistor, 15,000 ohms, R3;
- One I.R.C. Durham carbon resistor, 200 ohms, R4;
- Two I.R.C. Durham carbon resistors, 500 ohms, R5, R6;
- Two I.R.C. Durham carbon resistors, 50,000 ohms, R7, R8;
- Three I.R.C. Durham carbon resistors, 1 meg., R9, R10, R12;
- One I.R.C. Durham carbon resistor, 1/2-meg., R11;
- One I.R.C. Durham carbon resistor, 2,000 ohms, R13;
- Two Perry No. 3 coated, 20-watt resistor, R14 180 ohms, R15 240 ohms;
- One Magnavox type 154 special, dynamic reproducer; field coil 75 ohms; built-in output transformer T2 primary matches the push-pull 48's;
- One Amertran type AF-8 input transformer, T1;
- One Stancor 25 hy. choke of 50 ma. rating, CH.;
- Four Aluminum Goods Co. of America tube shield cans for V1 to V4;
- One DeJur-Amsco flying-spot tuning dial;
- Three RCA Radiotron type 239 tubes, V1, V2, V3;
- One RCA Radiotron type 236 tube, V4;
- One RCA Radiotron type 237 tube, V5;
- Two RCA Radiotron type 48 tubes, V6, V7;
- One 6 V. pilot light, 0.15-A., V8;
- Five Micarta Fabricators 5-prong sub-panel type sockets, for V1, V2, V3, V4, V5;
- Two 6-prong Micarta Fabricators 6-prong sub-panel type sockets, for V6, V7;
- One Micarta Fabricators 4-prong sub-panel type socket, for reproducer cable plug;
- One Eby twin-type binding post strip, for phonograph pickup;
- One Blau aluminum chassis, 1/16-in. thick and 8 1/2 x 13 1/2 x 3 ins. high;
- Three Kurz-Kasch brown bakelite knobs, for controls;
- One Savil midjet cabinet, type 748 Special.

You "Wind" This Pen

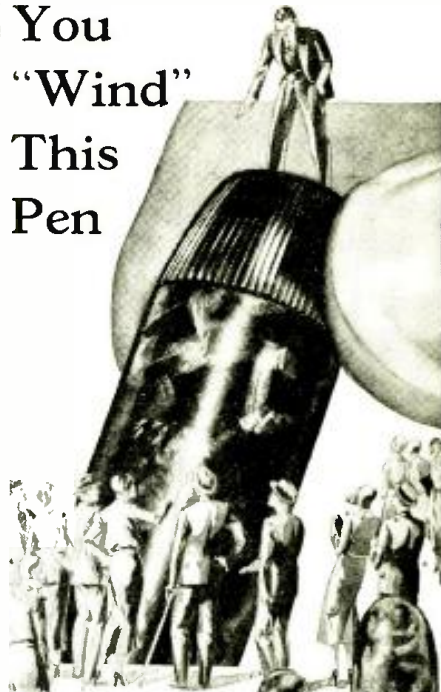

YOU turn the knurled end of the barrel to fill or empty the new Conklin Nozac (no sack). There is no rubber sack in this new pen. The ink capacity is 35% greater than sack pens. Here is the greatest student's pen ever made.

And there is a transparent section in the barrel through which you can see at all times how much ink is in the pen and be reminded to refill it. Made in beautiful new colors at \$5.00 and more. Pencils to match \$3.50 and more. Another outstanding pen is the Conklin Endura at \$5.00 and more—the peer of the best of all pens employing the familiar rubber sack ink reservoir.



Left to right—The Conklin Ensemble \$3.00. The new \$1.00 Conklin Pen. Genuine Conklin at \$2.00.

THE CONKLIN PEN COMPANY
Toledo Chicago San Francisco

Conklin
NOZAC

REG. U.S. PAT. OFF.

SATISFACTION GUARANTEED

A NEW 2-VOLT SUPERHETERODYNE

(Continued from page 340)

mounted on the front chassis wall. Switch 48 in series with the chassis and the "A" minus socket terminal 47, is an integral part of the volume control. Transformer 39 is mounted on the side wall and the eight Amperites are also mounted on the side walls, as shown in Fig. B.

The R.F. choke, 34, the fixed resistors, and the cartridge-type condensers are all fastened in place during the process of wiring, being soldered as close as possible to the parts with which they function. The "C" battery is mounted beneath the chassis in the rear corner, being held in place by a 1/2 in. brass strap; in order to more clearly show the position of each component, the battery was not connected into position when the underside view, Fig. B, was taken.

The two coils 2 and 12 are mounted last, two mounting holes being required for each coil. Before coil 12 is mounted, it must be altered in order to serve as an oscillator. Remove the two turns of silk-covered wire and also disconnect the primary (the coil wound on a piece of wood within the fiber form). This is done by unsoldering the connections at the terminals marked "P" and "B." Next, wind about 25 turns of No. 36 enamelled wire on the end of the coil nearest the terminals, soldering the lower end of this new coil to the "P" terminal and the upper end to the "B" terminal. This winding is used as the plate coil.

Then take off about 35 turns from the grid end (top) of the winding on the fiber form. This will leave a coil about 13/16 inch in length. Resolder the end of this coil to the "C" terminal. These turns are removed so that condenser 13 will track with condenser 4. For exact tracking, a few more or less turns may be required and this must be determined by experiment after the set is in operation. All tests should be made with the coil shields in place. After all adjustments have been completed, the coil shields are permanently soldered to the coil bases.

The set is now ready for wiring. The filaments are wired in first, leads next, the bypass condensers, and, finally, all plate leads. For tone control, substitute an Electrad RI-203 potentiometer for the fixed resistor at 37. Connect the movable arm to one end of an .02-mf. cartridge condenser, with the other end of the condenser grounded to the chassis. Be sure to peak the I.F. transformers at 465 kc. The writer will be glad to advise further concerning the components, etc., used in this superheterodyne.

Top and bottom layouts for this receiver may be obtained from the writer by enclosing 5c to cover mailing costs.

List of Parts

Two Cardwell "Midway" type 407-B variable condensers, 365 mmf., 4, 13;
 One Electrad volume-control potentiometer, 100,000 ohms, type RI-242-P, 26, with switch, 48;
 One Electrad tone-control potentiometer, type RI-203, 37, to be substituted for fixed resistor (see constructional directions);
 Three Automatic Winding Company 465 kc. I.F. transformers, complete with I.F. coils, tuning condensers and shields, 17, 21, 29;
 One Automatic Winding Company shielded antenna coil, 2;
 One Automatic Winding Company shielded R.F. coil (see directions for using this as oscillator coil), 12;
 Two Aerovox mica condensers, type 1450, 150 mmf., 6, 14;
 One Aerovox mica condenser, type 1450, 100 mmf., 7;
 One Aerovox mica condenser, type 1450, .001-mf., 33;
 Five Aerovox cartridge condensers, type 281, .02-mf., 9, 10, 19, 23, 31;
 One Aerovox cartridge condenser, .05-mf., type 281, 36;
 One Trutest R.F. choke, type 2H 10214, 34;
 One Trutest push-pull input transformer, type 2C1551, 39;
 Six Trutest 4-prong wafer-type sockets, 8, 16, 20, 24, 32, 38;
 Two Trutest 5-prong wafer-type sockets, 40, 41;

NEW TUBES

(Continued from page 335)

the bias is established across the grid leak. This decrease in effective bias voltage causes an increase in plate current which in turn raises the grid current and increases the opposing drop. This effect is cumulative, and in some circuits may reach such proportions as to damage the tube and even result in destruction.

The conditions just described will not be encountered if a grid choke with a low D.C. resistance is employed in place of a grid leak. Of course, this tube may be operated either alone, two in parallel, or two in a push-pull connection. A standard four-prong socket is used and the curves given in Figs. 5 and 6 are especially useful.

The following characteristics obtain when used as a class A amplifier: Filament voltage, 7.5; plate voltage, 350 to 425; grid bias, -72 to -100; load resistance, 5,000 to 8,000 ohms; amplification factor, 3; plate resistance, 2,400 to 2,500 ohms; mutual conductance, 1.250 to 1,200 micromhos; plate current 34 to 28 ma.; peak permissible grid swing, 68 to 96 volts; undistorted output power, 2.1 to 3 watts.

The following ratings obtain when used as a modulator: Maximum plate voltage, 425; maximum plate dissipation, 12 watts; grid bias, -101 volts; modulation factor .68; D.C. plate current, 25 ma.; peak grid swing, 97; oscillator input per modulator tube, 14 watts.

The curves given in Fig. 6 should be especially useful for the transmitter amateur in the process of designing a 'phone transmitter.

The 59 Power Output Pentode

In the October issue of RADIO-CRAFT the author described a new universal automotive output tube capable of being operated either as a class A triode, a class A power-output pentode, or as a class B power-output triode, this tube being known as the 59. In this issue, we described its companion tube in the 2 1/2-volt line known as the 59. For details concerning the connections of the grid in order to secure any of the classes of operation mentioned above, the author suggests that the readers refer to the October issue of RADIO-CRAFT.

(Continued on page 379)

One Trutest 6-prong wafer-type socket for power connections 45, 46, 47, 50, 51, 52;
 One Trutest 6-prong plug for making cable connection with 6-prong socket;
 Two Trutest binding posts, 1, 3;
 Two Trutest bakelite vernier dials, type 2H9803;
 One 22 1/2 volt "C" battery with 16 1/2 volt tap, 42, 43, 44;
 Three 45-volt "B" batteries;
 Six amperites, No. 632, with mountings, 8A, 16A, 20A, 24A, 32A, 38A;
 Two amperites, No. 633, with mountings, 40A, 41A;
 One I.R.C. (Durham) 15,000-ohm metallized resistor, 1/2-watt, type F-1/2, 25;
 Two I.R.C. (Durham) 30,000-ohm metallized resistors, 1/2-watt, type F-1/2, 11, 27;
 Two I.R.C. (Durham) 50,000-ohm metallized resistors, 1/2-watt, type F-1/2, 18, 22;
 One I.R.C. (Durham) 50,000-ohm metallized resistor, 1 watt, type F-1, 30;
 One I.R.C. (Durham) 60,000-ohm metallized resistor, 1/2-watt, type F-1/2, 28;
 One I.R.C. (Durham) 100,000-ohm metallized resistor, 1/2-watt, type F-1/2, 15;
 One I.R.C. (Durham) 150,000-ohm metallized resistor, 1 watt, type F-1, 35;
 One I.R.C. (Durham) 500,000-ohm metallized resistor, type F-1, 1 watt, 37;
 One I.R.C. (Durham) 1 meg. metallized resistor, 1/2-watt, type F-1/2, 5;
 Three type 130 2-V. tubes, 16, 32, 38;
 One type 132 2-V. screen-grid tube, 8;
 Two type 134 2-V. variable-mu pentode tubes, 20, 24;
 Two type 133 2-V. output pentode tubes, 40, 41;
 One roll Corwico braidite stranded hook-up wire;
 One Corwico battery cable, six wire, No. 231;
 One Blau aluminum chassis, 1/16th in. thick, 7 x 12 x 3 1/2 ins. high;
 One 1/2-amp. Instrument Littelfuse, No. 1004;
 One Littelfuse Gryp Connector, No. 1039;
 One Magnavox No. 254 permanent magnet speaker with push-pull output transformer to match type 133 output tubes.

SAY!

If you service men haven't got around to handling Amplifiers and making Amplifier installations, you are passing up easy money! Take, for instance, your 50-year-old friend, the SAMSON ELECTRIC COMPANY, and its PAM-110, the marvel of all Class B Amplifiers. Here is the lowest priced unit judged by the amount of power (26 watts) per dollar cost.

Yes, sir, SAMSON has given you a fast one in the PAM-110—for 110 volt current, 50-60 cycles, with variable output impedance for voice coil, to line or to magnetic speakers and designed for operation with the SAMSON MIK-110 . . . a combined input mixer, input coupling device, and tone modifier.

Here's a chance to add to your line profit-making items which are gaining widespread attention.

SPECIAL OFFER: Our Bulletin RC2 covers the theoretical and practical uses of Class B Amplification and the complete story of the PAM-110 and the MIK-110. Send stamps, totaling 15c to cover the cost, and address:

R. W. COTTON
 Samson Electric Co., Canton, Mass.
 Member R.M.A. Mfrs. Since 1882

More Capacity at Less Cost

LATEST research by oldest condenser manufacturer is reflected in present extensive and varied line of

DUBILIER ELECTROLYTICS

Available in all types—round and square metal cans, cardboard containers, tubular paper wrappings, high-voltage, low-voltage, tapped units, etc. Positively guaranteed for quickest reforming time, lowest leakage, highest working voltage, longest life. And they cost less!

WRITE for literature on Dubilier Electrolytics as well as all other types of condensers.

Dubilier Condenser Corporation
 4377 Bronx Blvd. New York City

SERVICEMEN-DEALERS
 Send 25c for our Handbook & Catalog
 Complete Stock of NEW Radio Replacement Parts
 Hard to Get Parts—We have them. Send us your repair work for estimate.
 Grant Radio Laboratories
 6521-C South Halsted St., Chicago, Ill.

SERVICEMEN!
 New 96-Page 1933 Edition LYNCH Resistor Manual Now Ready!
 Postpaid \$1.00 or
FREE with each Ten Resistors ordered
 Write for Folder and Discounts
 LYNCH MFG. CO., Inc.
 1775 Broadway New York City

Mayo REPLACEMENT PARTS



For All Standard Receivers

SERVICE MEN know that replacement units for receivers must measure up to exactly the same standards in every respect as the original. Parts manufactured by MAYO are exactly made, constructed with materials of superior quality, and guaranteed for six months. MAYO Replacement Parts have been continually used by Service Men for many years—they fill every requirement.

MAYO Replacement Parts are made for use in over 100 standard radio receivers. The parts listed below are manufactured by MAYO.

- | | |
|--------------------|-------------|
| Condensers | Chokes |
| Transformers | Coils |
| Resistances | Power Packs |
| Voltage Dividers | Microphones |
| Voltage Regulators | etc. |
| Filter Blocks | |

Look for the MAYO signature on every replacement part—it marks your guarantee of the precision product.

Write today, address Dept. RC, for free book-let showing complete list of MAYO STANDARD REPLACEMENT PARTS.

MAYO LABORATORIES, Inc.

281 East 137th Street New York, N. Y.
Oldest and largest manufacturer of replacement units

FREE Write for this Book today!

YOU CANNOT POSSIBLY AFFORD TO BE WITHOUT THIS VALUABLE BOOK.

It is an 400 page ENCYCLOPEDIA of the RADIO INDUSTRY

WHOLESALE PRICES!

Write for this Book today!

FREE Write for this Book today!

YOU CANNOT POSSIBLY AFFORD TO BE WITHOUT THIS VALUABLE BOOK.

It is an 400 page ENCYCLOPEDIA of the RADIO INDUSTRY

WHOLESALE PRICES!

Write for this Book today!

FREE Write for this Book today!

YOU CANNOT POSSIBLY AFFORD TO BE WITHOUT THIS VALUABLE BOOK.

It is an 400 page ENCYCLOPEDIA of the RADIO INDUSTRY

WHOLESALE PRICES!

COAST TO COAST RADIO CORPORATION

123 West 17th St., New York N.Y.

Write for this Book today!

YOU CANNOT POSSIBLY AFFORD TO BE WITHOUT THIS VALUABLE BOOK.

It is an 400 page ENCYCLOPEDIA of the RADIO INDUSTRY

WHOLESALE PRICES!

Write for this Book today!

FREE Write for this Book today!

YOU CANNOT POSSIBLY AFFORD TO BE WITHOUT THIS VALUABLE BOOK.

It is an 400 page ENCYCLOPEDIA of the RADIO INDUSTRY

WHOLESALE PRICES!

COMPLETE P.A. SYSTEM CONSISTING OF:

- 1 Pentode Amplifier
- 1 Matched Dynamic Cone Speaker
- 1 Midget Lapel Mike
- 1 Input Stage Control
- 1 15' shielded cable.

Special servicemen's and dealer's net price \$29.25. Also complete line of Portable P.A. and Intercommunicating Systems.

New Professional 2 button mikes list \$12.00 up, and 150 other Public Address items manufactured by us. Write for catalogue R.C.

Miles Reproducer Company, Inc.
Miles Reproducer Bldg.,
244-46 West 23rd St.,
New York, N. Y.

Full details about the OFFICIAL REFRIGERATION SERVICE MANUAL will be found on Page 377 of this issue. Turn to the announcement NOW.

OPERATING NOTES

(Continued from page 349)

service department, and they advised the lady that a condenser was "shot" and that it would have to be replaced. They did, (?) and returned the machine to her together with a bill for \$15.00. When it was placed in service again it was in the same condition as before.

We were then called in to service the instrument and the first thing we did was to turn on the set. All tubes were checked and found O.K.; likewise all voltages were O.K., however, after waiting about half an hour p-l-o-p and no reception. The tubes were again examined and it was found that all filaments were lighted but that there was no plate voltage on any of the tubes whatever. There was, however, a slight excess plate voltage on the leads from the '30 rectifier. The set was then brought to our shop for examination.

Our tests showed that the trouble was in the aluminum can that housed the power transformer and the filter chokes; because after the leads had been disconnected the condensers and the resistor all checked O.K. In other words, this appeared to be just one of those things. An examination of this can revealed that the transformer and double choke had been dropped in haphazardly and then filled with compound. Naturally when it was heated after the set had been in operation for about 20 minutes, any vibration whatever would cause the chokes to drop down and touch the high voltage terminal. As soon as the set was turned off the contraction of the mass of compound would open this contact and the machine would operate until sufficient heat was generated to soften the compound allowing the chokes to sink, at which time it would cease operating.

We opened the can in question instead of replacing it (the lady was pretty well disgusted with the machine after the so-called service she had received), heated the unit in an oven until the compound ran and then insulated the chokes and transformer from the side of the can and from the high voltage terminal.

STATEMENT OF THE OWNERSHIP, MANAGEMENT, CIRCULATION, ETC., REQUIRED BY THE ACT OF CONGRESS OF AUGUST 24, 1912.

Of Radio-Craft, published monthly at Mt. Morris, Ill., for October 1, 1932.
State of New York }
County of New York }^{ss.}

Before me, a Notary Public in and for the State and county aforesaid, personally appeared Irving S. Manheimer, who, having been duly sworn according to law, deposes and says that he is the business manager of the Radio-Craft and that the following is, to the best of his knowledge and belief, a true statement of the ownership, management (and if a daily paper, the circulation), etc., of the aforesaid publication for the date shown in the above caption, required by the Act of August 24, 1912, embodied in section 411, Postal Laws and Regulations, printed on the reverse of this form, to wit:

1. That the names and addresses of the publisher, editor, managing editor, and business managers are: Publisher, Techni-Craft Publishing Corp., 404 North Wesley Ave., Mt. Morris, Ill.; Editor Hugo Gernsback, 98 Park Place, New York City; Managing Editor, Louis Martin, 98 Park Place, New York City; Business Managers, Irving S. Manheimer, 98 Park Place, New York City.
2. That the owner is: (If owned by a corporation, its name and address must be stated and also immediately thereunder the names and addresses of stockholders owning or holding one per cent or more of total amount of stock. If not owned by a corporation, the names and addresses of the individual owners must be given. If owned by a firm, company, or other unincorporated concern, its name and address, as well as those of each individual member, must be given.) Techni-Craft Publishing Corp., 404 North Wesley Ave., Mt. Morris, Ill.; Hugo Gernsback, 98 Park Place, New York City; Sidney Gernsback, 98 Park Place, New York City; I. Manheimer, 98 Park Place, New York City.
3. That the known bondholders, mortgagees, and other security holders owning or holding 1 per cent or more of total amount of bonds, mortgages, or other securities are: (If there are none, so state.) None.
4. That the two paragraphs next above, giving the names of the owners, stockholders, and security holders, if any, contain not only the list of stockholders and security holders as they appear upon the books of the company but also, in cases where the stockholder or security holder appears upon the books of the company as trustee or in any other fiduciary relation, the name and address of the person or corporation for whom such trustee is acting, is given; also that the said two paragraphs contain statements embracing affiant's full knowledge and belief as to the circumstances and conditions under which stockholders and security holders who do not appear upon the books of the company as trustees, hold stock and securities in a capacity other than that of a bona fide owner; and this affiant has no reason to believe that any other person, association, or corporation has any interest direct or indirect in the said stock, bonds, or other securities than as so stated by him.

I. S. MANHEIMER,
Business Manager.

Sworn to and subscribed before me this 26th day of September, 1932.

(Seal)

JOSEPH H. KRAUS,
Notary Public.

(My commission expires Mar. 30, 1933.)

3 New 50c Books



No. 1. FORMULAS AND RECIPES

For the Practical Man
By S. GERNSBACK

An extremely helpful book showing you how to save money by making in your own home, at a fraction of the regular cost, the hundred and one preparations which you now buy for use at home or business.

PARTIAL CONTENTS:

1. Adhesives: Glues, Cements.
2. Cleansing: Stain Removers, Bleaches.
3. Metal Craft: Coloring, Oxidizing, Plating Polishes.
4. Paints: Colors, Stains, Varnishes.
5. Glass-Working: Cutting, Drilling, Boring, Etching, Engraving.
6. Wood-Craft: Fireproofing, Acid-proofing, Waterproofing, Furniture Polishes.
7. Inks: Sympathetic, Invisible, Hectograph.
8. Photography: Developers, Emulsions, Fixers.
9. Antidotes for Poisons, Remedies for Burns and Scalds, Disinfectants.
10. Preparation, Manipulation, Handling, Mixing, Tables of Weights and Measures, Useful Tables.

No. 2. FUNDAMENTAL PRINCIPLES OF RADIO

Radio Simply Explained—Its Origin, Nature and Functions

By LOUIS MARTIN



Prepared with special consideration given to young members in the radio profession, and those who have gained their experience in a haphazard fashion. This radio primer is a handy fundamental aid for "checking up" and systematizing your knowledge of radio. Regardless of how much you know about the subject, you should read this book.

PARTIAL CONTENTS:

- Chapter I—Fundamentals of Radio: Electricity, Resistance, Batteries, The Magnetic Circuit, The Magnetic Field, Inductance, Condensers, A.C. Circuits, Propagation of Radio Waves; Chapter II—The Simple Radio Set, Single, Two, and Three-Circuit Tuners, The Battery Set, Vacuum Tubes, Electric Sets, Loud Speakers; Chapter III—Diagrams, How to Read Them; Chapter IV—Amateurs and Broadcast Stations, Talking Pictures, Television.

No. 3. ELEMENTARY MATHEMATICS

for the Technician and Craftsman

By C. SHAINMARK

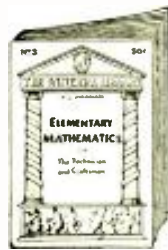

This manual has been especially prepared for the man who wishes to acquire a working knowledge of the elementary principles of mathematics. A complete treatment of the subject is given by the author, Mr. C. Shainmark, with special attention to the use of mathematics in Radio and other technical work for those who employ its formulas daily.

PARTIAL CONTENTS:

- I—Arithmetic: Addition, Multiplication, Subtraction, Division, How to Use Decimals; II—Fractions, Percentages, Ratio and Proportions; III—Powers and Roots; IV—The Metric System; V—How to Measure Surfaces and Volumes; VI—Mathematics for the Manual and Technical Craftsman; VII—Special Mathematics for the Radio Technician; VIII—Commercial Calculations, Short-cut Arithmetic, Interest Calculations, Discounts; IX—Weights and Measures; X—Useful Tables.

All our books are of uniform size, 6 x 9 inches, and contain 64 pages. The books are printed on strong paper with stiff colored covers.

PRESS GUILD INC., 16 Murray St., New York, N. Y., RC-12

Enclosed find \$..... for which mail me postpaid the following books:

- No. 1 No. 2 No. 3
50c each, Postpaid.

Name

Address

City and State

A MUTUAL CONDUCTANCE METER

(Continued from page 341)

alternating voltage is applied, secured by a voltage divider across the usual 60 cycle, A. C. line. In the plate circuit, the alternating current resulting from the A. C. on the grid is measured by means of the rectifying unit and D. C. meter. A resistor is used to supply a path to the plate for the D. C. in the circuit, which is blocked from the meter by a 2 mf. condenser. Thus, regardless of the D. C. value of the plate current, the meter will not read until A. C. is applied to the grid, and the reading, regardless of the type of tube, will be solely dependent on the mutual conductance.

The complete design is indicated in Fig. 2. Resistors R1, R3, and R4, with the rheostat R2, form the input circuit. Resistors R5 and R6 in the plate circuit form a path for the D. C. plate current; R5 being used for power tubes with low plate resistance while R6 is used for all other tubes. The miniature, copper-oxide rectifier and meter are connected in series with the input resistors (terminals 9 and 11 to terminals 1 and 2) to adjust for line-voltage variations; and, to read mutual conductance, are connected with the blocking condenser, across either R5 or R6, depending on the type of tube under test. The key switch SW.1 when in a neutral position, connects the meter and rectifier in the input circuit and the line voltage may be adjusted.

When thrown to the right, the meter and rectifier are transferred to the plate circuit; and, with the condenser in series, are shunted across R6. With the toggle switch SW.2 also thrown to the right, mutual conductance of all tubes which have no control-grid cap, other than the 3-element power tubes, may be read. With the toggle switch SW.2 thrown to the left, SW.1 remaining as above, all tubes with a control-grid cap may be tested. With SW.1 thrown to the left, the toggle switch is out of the circuit and the meter is adapted to testing 3-element power tubes.

The condensers C2, C3, and C4, and the switch SW.3 are needed only when the tester is used in the field. They serve as by passes for circuit elements in the radio set. The switch SW.3 is closed when testing power tubes and connects the cathode terminal to the center tap of the filament shunt resistor which is across the filament supply terminals of the power tube.

The resistors, R1, R3, and R4, should be of 1-watt rating, and preferably wire-wound. R3 and R4 should be accurate to within 1 per cent; R2 may be any good volume control of 100,000 to 200,000 ohms resistance; R5 and R6 are heavy-duty, wire-wound resistors, 50 watt rating; the 2 mf. condenser C1 should be of high quality with no leakage. The voltage across it is small, but to ensure no leakage, it is better to use a 300-volt condenser at this point. Condenser C2 should be a high voltage electrolytic; C3 and C4 need only have a 160-volt rating.

The miniature copper-oxide rectifier is a Tau-rex; the meter, a Weston O-1. ma. (the one shown in the photograph is the galvanometer from a thermo-galvanometer which had its thermo-couple removed and has been shunted to give a full scale deflection for 1.ma. D. C.).

If an accurate 0-10 ma. A.C. meter is available, the calibrating of the meter may be done as shown in Fig. 3. If not, tabulated calibration points are given below:

micromhos	scale divisions (D.C.)
400	9
600	19
800	30
1000	40
1200	51
1400	64
1600	75
1800	87
2000	98

Construction Details

The meter should be removed from its case and the dial taken off, being careful not to touch the pointer, and the printing immediately above the dial scale should be removed by rubbing same with a dampened eraser. The calibration may be marked in, using a fine pen and india ink. Replace the dial, and put the meter back in its case, taking particular care that the zero adjustment notch fits in its proper place.

The apparatus may now be assembled and wired. A 7x10 in. bakelite panel is used. The terminal block shown in Fig. 2 was taken from a discarded Radiola radio-record switch; a binding post strip, however, may be substituted. If there is any difficulty in obtaining the key switch, SW.1, the switches A and B, Yaxley D. P. D. T., (also shown in Fig. 2), may be substituted. Switch A may be a push-button type as it is used for line-voltage adjustment only. For service work, condensers C2, C3, and C4, and switch SW.3 are needed. The condensers may be mounted in the box containing the apparatus. SW.3 should be mounted on the panel. An analyzer plug with 6 prongs, adapters for 4- and 5-prong sockets, and a 7-wire cable are also needed for service work.

For screen-grid tubes, the applied A.C. grid voltage is 1.2 (R.M.S.). For all other tubes, except 3-element power tubes, the applied A.C. grid voltage is 10 per cent higher, or 1.32 (R.M.S.), to compensate for the plate circuit load. For 3-element power tubes, the applied A.C. grid voltage is 5.5 (R.M.S.). These voltages are simply and accurately determined by adjustment of the rheostat R2 with the key switch in neutral position, which connects the meter and rectifier in series with the A.C. line. With 100,000 ohms in series, this meter will give a full-scale deflection for 117 volts A.C. Therefore, the current through the rectifier at this voltage is 1.17 ma. The portion of the voltage divider furnishing the applied grid voltages R3 and R4, have a combined resistance of 5,250 ohms. Therefore, if we adjust the rheostat R2, until 1.05 ma. A.C. is flowing through R3 and R4, the voltage drop across R3 and R4 will be 5.5; across R4 alone, the drop will be 1.3 volts. Thus, with a single adjustment, we have the proper test voltages for all types of tubes other than screen-grids with a control-grid cap. For the latter, the setting required is 10 per cent lower as no compensation is necessary due to the high plate resistance of this type of tube. Since the meter reads 100 when 1.17 ma. A.C. is passing through the rectifier, it will read 1.05/1.17 of 100 or 90 when 1.05 ma. A.C. is in the circuit. So we therefore adjust the meter to read 90, by means of the rheostat, except for tubes with the control-grid cap, for which we adjust the meter to read 10 per cent lower, or 81.

Some power tubes have a mutual conductance greater than 2,000, and as our scale extends only to 2,000, provision must be made for testing these tubes also. However, this is very simply done. If we reduce our input voltage by one-half, we may double the mutual conductance readings indicated on the meter. Therefore, if the meter goes off scale on any tube, readjust the line voltage setting until the meter reads 45 and double the indicated mutual conductance readings.

It is easy to remember what the mutual conductance of new tubes of various types should be. The '27, '26, '24, and '35, will all average around 1,000 micromhos. Power tubes, such as the '71A, '45, '50, will read around 1,800 or 2,000, while power pentodes will read slightly higher. Battery type tubes, such as the '01A, '99, '12, will read around 600 to 800, with the '22 type still lower. Tubes should be replaced if their mutual conductance has dropped to $\frac{1}{2}$ or $\frac{1}{3}$ of these values. In R.F. stages, even a 10 per cent drop makes an appreciable difference, especially when there is some regeneration present.

This tester may also be used as a tube voltmeter for measuring voltages by simply putting a tube in one of the test sockets and connecting the unknown voltage in series with the grid. The mutual conductance of the tube is first measured in the usual manner; then the applied A. C. test voltage is removed from the grid. The mutual conductance reading has indicated the reading to be expected for a known input voltage. The unknown voltage is therefore greater or less than the mutual conductance reading depending upon the ratio of the indicated mutual conductance with the unknown voltage applied to that of the reading with the known applied voltage. The tube selected for this purpose should have a normal operating grid bias well in excess of the peak voltage to be measured.

NEW I.R.C.

COMBINATION KIT

Containing:-

1/2 Watt, 1 Watt and 2 Watt METALLIZED RESISTORS

and

5 Watt and 10 Watt

POWER WIRE WOUND UNITS

These include the popular ranges—the ranges of the resistors that are most needed in radio replacement work today. We are combining them in one handy Kit for the convenience of Servicemen.

Together with other I. R. C. handy Kits, it is now on sale at your jobber's. Write us for folder giving full information—also new complete 16-page catalog on I. R. C. products, just off the press.

INTERNATIONAL RESISTANCE COMPANY

2006 Chestnut Street, Philadelphia

74 Wellington St., West, Toronto, Ontario

Makers of *Metallized*

and POWER WIRE WOUND—PRECISION WIRE WOUND

RESISTORS

STOP! CRASHES!!

Clicks and Noises of Man-Made Static in Your Radio Reception
YOUR PROBLEM SOLVED

From our experience installing over 10,000 Radio Outlets, we knew what was needed. Exhaustive research and development have contributed this major achievement to the Radio Industry.

You Get Results

at small cost, with the **NEW "AKAformer" Kit**



Quickly and easily ached to any aerial or Radio set by anyone. Send for folder and give name of your Jobber.

DEALERS AND SERVICE MEN

A sample AKAformer Kit will be sent, at our Special Price of \$2.50

Clip this adv. attach to your letterhead, with check or money order for the amount. This offer is good only to Dec. 1st. After that, our regular list price of \$5.00 will be in effect, less usual discounts.



Trade Mark

Amy, Aceves & King, Inc.
Consulting Engineers
17 West 42nd St., New York
Inventors of this type of noise elimination

SERVICEMEN RADIO DEALERS



SEND FOR THIS
**FREE 100 PAGE
CATALOG!**

**IT'S CHOCK-FULL
OF BARGAINS FOR YOU**
Radio Dealers and Servicemen
can't afford to be without this
book. It offers marvelous buys
in Radio Sets, Long and Short
Wave Apparatus, Servicemen's
Repair and Replacement Parts,
Electrical Goods, Sporting
Goods.

JUST OFF THE PRESS!

Be among the first to have the pick of
great bargains. Mail this coupon now!

RADIO CIRCULAR CO., INC.
225 Varick St.
New York, N. Y.

Dept. RC.

Please send me free of charge and with-
out obligation, your latest catalog.

Name

Address

City..... State.....

CONCOURSE

Dry Electrolytic

Condensers

In Tubular Containers

Save time and money for
servicemen

LOW AND HIGH
VOLTAGES

Capacities from 1/2
8 mfd.

Housed in moisture
proof paper tubes.



Type B
(Above)



Type P.T.W.

MULTI TAP

Wax Paper
Condensers

In Various Capacities
Continuous non-in-
ductive winding

Write or Wire for Our Complete Descriptive
Catalogue

CONCOURSE ELECTRIC CO., Inc.
389-409 Wales Ave. N. Y. City



Study RADIO in CANADA

A start in Radio Guaranteed or your money back.
Course covers Radio, Television, Sound Amplification
and Telegraphy. Practical work material supplied.
Preparation for Government and Service examina-
tions. Home Study, Day or Evening Classes. Write
for booklet.

RADIO COLLEGE of CANADA
Limited

310 Yonge Street Toronto, Canada

LOUDSPEAKER FACTS

(Continued from page 342)

then the baffle length is infinite. Therefore, if
the loudspeaker and amplifier are capable of
supplying down to the lowest transmitted fre-
quency, the baffle will also reproduce this fre-
quency. Under such ideal conditions we would
indeed have an ideal sounding system.

Reverberation and echo will spoil the best
sounding system. Reverberation is also known
as "Multiple Reflection," and is the reflection of
the sound from walls, ceiling and floor, gradu-
ally losing a little energy at each reflection until
ultimately the sound dies out to inaudibility.
The time that it takes for a given signal to com-
pletely die out is the duration of audibility of
the reverberation. The rate at which reverber-
ation disappears is proportional to the rate at
which sound is absorbed, and thus all substances
have different relative absorbing powers.

Echo, on the other hand, is a special case
wherein a short, sharp sound is distinctly re-
peated by reflection, either once from a single
surface, or several times from two or more
surfaces.

There is still another condition which produces
resonance and is the result of the emanating
sound producing vibration in objects whose
fundamental period of vibration is excited by
the sound and therefore goes into continued vi-
bration. Such a phenomenon can produce a
most exasperating sound, for the guilty object
is oftentimes exceedingly difficult to locate.

Determining Loudspeaker Position

The position of the speaker on the wall is
of vital importance; likewise is the method of
sound distribution, or rather the type of mount-
ing that will be used with the speaker. The
distribution of sound can be likened to the dis-
tribution of light, and if a source of light is
placed in a position corresponding to the focal
point of the loudspeaker, then the angle of the
light beam can be taken as a visual indication
of how the sound waves emanating from the
loudspeaker will disperse throughout the room.

First, the angles of distribution must be ob-
tained by using a searchlight with a variable
focus attachment, and, by holding the light in an
approximate location for the loudspeaker and
varying the focal length, the light will cover
the entire room (Fig. 1B). A definite angle will
be found that will easily cover the major portion
of the room. This angle must be measured and
will be the horizontal distribution angle. (Of
course the only light in the room while these
measurements are being made will be due to
the searchlight.)

Second, the floor angle, Fig. 1C, must be ob-
tained; and this is perhaps the most important
measurement to be made, as this angle will also
take into consideration the true height above the
floor that the speaker must be placed. If the
speaker is installed near the ceiling on the 20-
foot wall and designed with the idea of only
covering the horizontal angle of distribution,
then there will be an almost complete dead spot
directly below the loudspeaker on the floor as
shown in Fig. 1D.

The floor angle must therefore be accurately
determined so as to cover that position nearest
the wall under the loudspeaker where sound will
be required. The usual method of measuring
this angle is to use a ladder and flashlight, and
by striking a balance between that point where
the horizontal distribution can cover its terri-
tory without blasting those in the front, and
where the floor angle drops down and delivers
its sound to the desired front location. Some
also consider the ceiling angle, especially where
the ceiling is constructed with highly reflective
material. In such a condition, the ceiling angle
is usually designed with a flat, horizontal angle;
the idea being to keep the sound from being
projected against the ceiling as much as possible.

At least seven or eight separate measurements
are made for each angle. The groupings for the
individual angles are then averaged and the
final three angles thus obtained are plotted on
paper. Then, by also laying out the resulting
horn to scale, usually known as a "Flare," the
distance from the front of the flare to the back
can be determined. The limits in the rear of
the flare will of course be the section where the
outside diameter of the cone just fits.

The ultimate result will be a unit that will
work directly into the space that it is designed
to cover. In actual practice, it will be found
that where rooms are of the same shape, the

MAILING LISTS

Pave the way to more sales with actual
names and addresses of Live prospects.

Get them from the original compilers
of basic list information—up to date—
accurate—guaranteed.

Tell us about your business. We'll help
you find the prospects. No ob-
ligation for consultation service.



**60 page Reference
Book and Mailing
LIST CATALOG**

Shows counts and prices on
8,000 lines of business.
Shows you how to get special lists by ter-
ritories and line of business. Auto lists of
all kinds.
Shows you how to use the mails to sell
your products and services. Write today.

R. L. POLK & CO.

Polk Bldg.—Detroit, Mich.

Branches in Principal Cities

World's Largest City Directory Publishers

Mailing List Compilers, Business Statis-
tics, Producers of Direct Mail Advertising.

CLASSIFIED ADVERTISEMENTS

Advertisements in this section are inserted at the
cost of ten cents per word for each insertion—
name, initials and address each count as one word.
Cash should accompany all classified advertisements
unless placed by a recognized advertising agency.
No less than ten words are accepted. Advertising
for the January, 1933 issue should be received not
later than November 9th.

CHEMISTRY

BECOME A TRAINED CHEMIST. Thousands
of opportunities—fascinating career. Learn at
home. Complete experimental laboratory outfit
given. Write for big free book. Chemical Insti-
tute, 19 Park Place, Dept. RC, New York.

DOGS

BEAUTIFUL Registered bull pups, \$15. Bull-
dogs. 501-RC, Rockwood, Dallas, Texas.

INVENTORS

PATENT YOUR INVENTION: Send for
FREE book, "How to Obtain a Patent," and
"Record of Invention" blank. Ask us about how
to protect your ideas. Deferred payment. Victor
J. Evans & Co., 620M Victor Bldg., Washington,
D. C.

RADIO

GUARANTEED MICROPHONE REPAIRS—
Any make or model—24 hours service. Stretched
diaphragm double button repairs, \$7.50. Others,
\$3.00. Single button repairs, \$1.50. Write for
1933 Catalog with diagrams. Universal Micro-
phone Co., Ltd., Inglewood, Calif.

TRANSFORMERS REWOUND, varnished,
baked, guaranteed, reasonable cost. **SPEAKER
REPAIRING,** magnetic \$2.00-\$2.50; dynamic,
voice coils, fields, etc., reasonable charges. Clark
Bros. Radio Co., Albia, Iowa.

**RADIO Service Men Attention—Power trans-
formers, rewound or rebuilt, to your require-
ments. Meyke Radio Service, 2624 Margaretta,
Maplewood, Mo.**

**RADIO Service Men: A guaranteed sure fire
business getter! Send two dimes for complete
details. Radio Service Laboratory, Wooster, Ohio.**

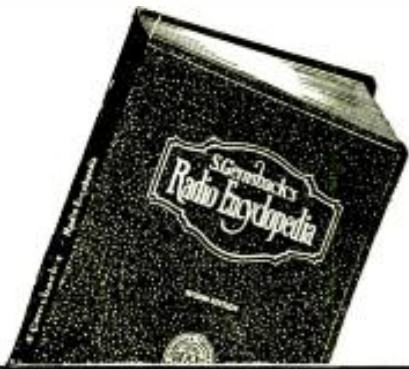

S. GERNSBACK'S RADIO ENCYCLOPEDIA

2nd EDITION

This New Second Edition gives you an explanation of every word used in radio.

2,201 RADIO DEFINITIONS

1,253 TECHNICAL

ILLUSTRATIONS

34 TABLES AND CHARTS

24 PAGES OF APPENDIX

Best Morocco-Keratol Flexible

Binding

Printed on strong ledger paper, Loose-Leaf

Arrangement

352 pages 9 x 12 inches. Weight 3 lbs.

\$3.98

S. GERNSBACK CORPORATION,
98 Park Place, New York, N. Y.

Send me a copy of the new Second Edition S. Gernsback's Radio Encyclopedia. I enclose herewith \$3.98, check or money order preferred. (Foreign and Canada, add 35c extra for postage.) Money refunded in full if not satisfactory.

Name

Address

City RC-12-32

State

The TRANSMITTER UNIT
with 100 Uses ~

95c

The Skinderviken
Microphone Button



MAKE YOUR OWN
LAPEL MIKE
OTHER USES:

RADIO AMPLIFIER PHONOGRAPH AMPLIFIER
DECTOGRAPH TELEPHONE AMPLIFIER
(Dictograph) LOUD SPEAKER AMPLIFIER
STETHOSCOPE CRYSTAL SET AMPLIFIER
HOME RECORDING OUTFITS

One Unit 95c; two for \$1.75
12-PAGE INSTRUCTION BOOKLET
containing suggestions and diagrams for innumerable
uses, furnished with each Skinderviken Button.

This is the smallest microphone made, measuring only
3/4 inches in diameter. It is filled with the finest polished
carbon grains obtainable.

—ULTRA SENSITIVE—

EVERY AMATEUR SHOULD HAVE TWO OR THREE
OF THESE MICROPHONE-AMPLIFIERS IN
HIS LABORATORY

SEND NO MONEY

When the postman delivers your order you
pay him for whatever you have ordered, plus
postage.

PRESS GUILD, Inc.,
16 Murray St., New York, N. Y.

RC-12-32

Please mail me at once as many of the following
Skinderviken Microphone Buttons as I have indicated.

One for 95c; Two for \$1.75;

Three for \$2.50 Four for \$3.20

I will pay the postman the cost of the items as speci-
fied, plus postage.

Name

Address

City

State

distribution angles will be similar, the greatest factor of discrepancy being the floor angle. Several manufacturers make flares to fit almost all conditions of sound work and photographs of these are shown here.

It is well to remember that in rooms where there is a tremendous amount of echo and reverberation the best method of sound coverage is to install small speakers all over the room and then to drop the volume so that each speaker will only cover a small area; but due to the fact that the volume is at such a low level, the sound will only be able to cover its own area and then fade out. The usual argument against the use of many speakers is that one speaker will overlap the other resulting in the listener hearing the signal from more than one direction, creating the feeling of a bad echo. This argument is true but it is only true where the level is raised so that overlapping points will result. It is not true where the level is adjusted to a low value that will only cover a predetermined area. The best results will be obtained where the ceiling can be opened and speakers inserted with the sound coming down and covering the desired area. In any case, it is much better than having one or two large speakers operating at high volume to cover a room, and then not being able to understand a word due to the preponderance of echo and reverberation.

Where a room is acoustically correct and can be fed by the type of unit described before, by all means use the large type speaker. The excellence in tone quality will more than repay the installation of such units.

In many large public places it is often necessary to prevent the sound that is being fed to one room from being heard in the adjoining room. Oftentimes the loudspeaker will feed a room and the back of the speaker will be in a second room where it is vitally important that the back wave should not create any disturbance.

The only thing to do in such a condition is to install the speaker and flare in a well padded box. The idea of completely enclosing the entire back of the speaker in a padded box might appear at first to be extremely poor practice. Actually, with the proper precautions, excellent sound can be obtained. The box should be made large enough so that the amount of space in the box can easily accommodate the increase in pressure when the cone is operating at high levels. Now in order to reduce the effect of cavity resonance and possible other troubles, the entire inside of the box is lined with 1/4-inch lining of hair wool. This is illustrated in Fig. 1E.

Determining Operating Level

The proper operating level for an amplifier working in a large room is a matter of considerable dispute. Some would have the volume very loud, others not quite so loud, while a third group would have the level extremely low depending on the type of program being reproduced. In order to easily compute the proper operating condition, the curve in Fig. 2 was drawn up. Given the constants of a room, it is a fairly easy matter to find the volume in cubic feet, and then by merely locating the value of power corresponding to that volume required, the amplifier power is known.

Now this curve will indicate the level that will be needed to fill the room with sufficient volume so that radiated sound can just be heard all over room. However, as explained before, this level will not be sufficiently high for those people who like to have their programs reproduced at fairly high levels. In other words, it will be necessary to increase the output power of the amplifier if we are to fulfill this item. Generally, a 50% increase in the power output will cover the requirements of any additional gain that may be required.

It follows therefore:

Volume in Cubic Feet = $20 \times 30 \times 45 = 45,000$ Cu. Ft. Referring to Fig. 2, 45,000 cubic feet corresponds to a power level of 5 watts, and in decibels this is approximately 29DB.

By increasing our power output by the safety factor of 50% we have: $5 + 2\frac{1}{2} = 7\frac{1}{2}$ watts or approximately 31 DB.

An examination of the RADIO-CRAFT tube chart, published in the July issue, will show that two '50 tubes in push-pull will just serve the purpose.

(In a following issue of RADIO-CRAFT, the author will discuss the problem of twin speakers. In view of the fact that this topic is of major importance at this time, the Service Man should acquaint himself with full details regarding their use.—Editor.)

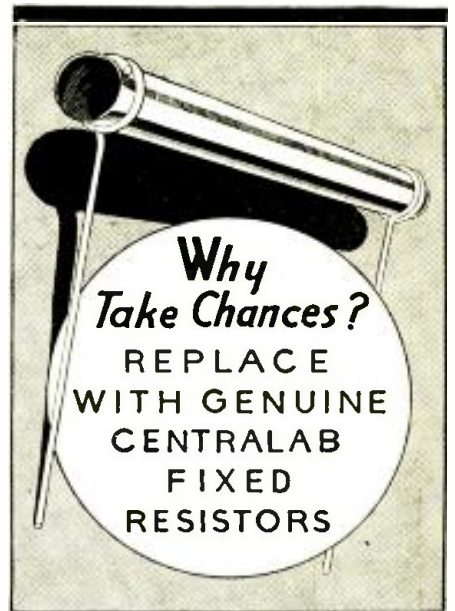

Why
Take Chances?
REPLACE
WITH GENUINE
CENTRALAB
FIXED
RESISTORS

CENTRALAB FIXED RESISTORS are Baptized with Fire in the making and will withstand a greater load than any other composition resistor of equal size.

Packed in handy carton of 10. Your choice of resistance values.

Centralab
CENTRAL RADIO LABORATORIES

930 E. Keefe Ave.
MILWAUKEE, WIS.

Mayo

The House of all Types of
Microphones and Public Address
Systems

To the radio industry MAYO offers a complete line of Microphones and Amplifiers for broadcasting, recording and public address work. Every Product is exclusively manufactured by MAYO, and tested, to meet standard requirements.

Our engineers, after exhaustive research, have produced MAYO microphones and public address systems, at a cost far below that at which other similar products may be obtained and they have incorporated every modern improvement in their design.



The Talk of the Industry

MAYO Model F: 2 1/4" diam. by 2 1/4" thick; two button mike. 24 Karat gold contact. 100 or 200 ohms per button; heat-treated duraluminum diaphragm; frequency, 60 to over 1000 cycles; weight (shipping) 1 1/2 lbs.; furnished in two models 1-damped and 2-sensitives; new process carbon granules; unconditionally guaranteed for three months. Price

\$15.00

PUBLIC ADDRESS ACCESSORIES

include amplifiers from 3000 to 5000 watts, microphones, transformers, stands, sockets, attenuators, faders, controls, cables, and other items.

Address Dept. CR for booklet on MAYO New and Improved Microphones. Sent FREE.

MAYO INSTRUMENT CORPORATION
281 East 137th St., New York, N. Y.

NEW AND IMPROVED MICROPHONES

The Radio-Craft Library is now complete!

Presented on this page are the new books of the RADIO-CRAFT LIBRARY—the most complete and authentic set of volumes treating individually, important divisions of radio. Each book has been designed to give radio men the opportunity to specialize in one or more of the popular branches of the industry. The material con-

tained in these books will increase your knowledge; you will find them a real help in your work and they will contribute to your money earning capacity. Read these books during your spare time at home.

The authors of these books are well-known to everybody. Each one is an expert radio man; an authority on the

subject—each is thoroughly familiar with the field which he represents.

This is perhaps the first real opportunity that you have ever had to build a radio library of books that are authentic, right-up-to-the-minute and written so that they are easily digested and clearly understood. Mail coupon below for your books.

**TO THE RIGHT
WILL BE FOUND
A SHORT RESUME
OF EACH BOOK**

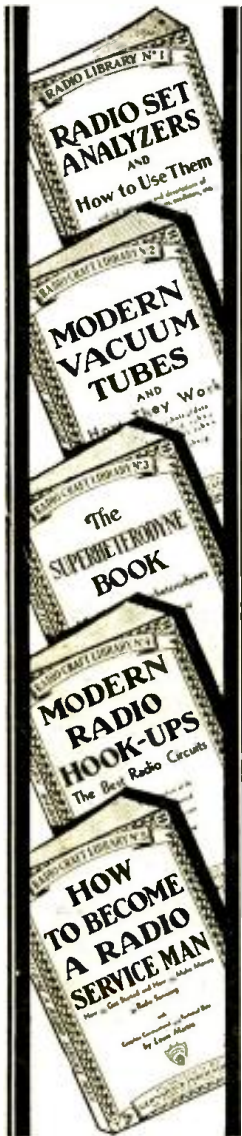

**Book No. 1
RADIO SET
ANALYZERS**
And How To Use Them
With Full Instructions and Descriptions of Set Analyzers, Tube Checkers, Oscillators, Etc.
By L. VAN DER MEL
This book explains thoroughly the operation of set analyzers, tube checkers, oscillators and other testing equipment. For every radio man this book is extremely helpful. It covers every phase of testing and gives you valuable short cuts; completely illustrated with photographs and diagrams to facilitate the use of modern testers.

**Book No. 2
MODERN VACUUM
TUBES**
And How They Work
With complete Technical Data on All Standard and Many Special Tubes
By ROBERT HERTZBERG
MODERN VACUUM TUBES describes the fundamental electron theory which is the basis of all vacuum tube operation, and goes progressively from the simplest two-element tubes right up to the latest pentodes and thyatrons. It is written in clear, simple language and is devoid of the mathematics which is usually so confusing. Valuable reference charts and characteristic curves of standard and special tubes are to be found, also diagrams of sockets and pin connections.

**Book No. 3
THE SUPERHETERODYNE
BOOK**
All About Superheterodynes
How They Work, How to Build and How to Service Them
By CLYDE FITCH
There is no more fascinating a subject in the large array of radio circuits than the famous superheterodyne circuit. Whether you are a Service Man or experimenter, first-hand knowledge about the construction of superheterodyne receivers is very important. The book on Superheterodynes gives underlying principles of their construction, right from the very first set made.

**Book No. 4
MODERN RADIO
HOOK-UPS**
The Best Radio Circuits
A Complete Compendium of the Most Important Experimental and Custombuilt Receivers
By R. D. WASHBURNE
It is fascinating to the experimenter, or even to the up-to-date Service Man, to take a commercial set and to change it into one using a famous hookup that is not found in any manufactured set. Many excellent circuits have never been commercialized, but limited only to homeset builders. Thousands of these popular circuits have been requested from time to time and in this book we have included over 150 circuits, which include the famous Perldyne, Cash-Box A.C.-D.C. Set and others.

**Book No. 5
HOW TO BECOME A
RADIO SERVICE MAN**
How to Get Started and How to Make Money in Radio Servicing
By LOUIS MARTIN
The ambition of many men in radio today is to become a first-grade Service Man. It is not as difficult as one might believe, but it cannot be done in a few short months. Following very carefully the advice of Mr. Martin, who has dealt with the problems of thousands of Service Men, this book deals very carefully with the essential stages in the preparation for qualifying as a Service Man.

**Book No. 6
BRINGING ELECTRIC
SETS UP TO DATE**
With Pentodes, Multi-Mus. Dynamic Speakers—Complete Information How to Modernize A. C., D. C. and Battery Operated Receivers
By CLIFFORD E. DENTON
In this country there are over ten million electrically operated receivers that could be modernized—by placing in them new type tubes, new speaker equipment and other modern improvements. This business of improving old sets can go to the experimenters and Service Men if they will quickly jump into action.
Read in this book by Mr. Denton, how easily you can modernize any obsolete set, and with little additional costs.

**Book No. 7
RADIO KINKS AND
WRINKLES**
For Service Men and Experimenters
A Complete Compendium on the Latest Radio Short-Cuts and Money-Savers
By C. W. PALMER
If often becomes necessary for experimenters and Service Men to call upon their memory for some short cut or radio wrinkle that will solve a problem quickly. In business, "short cuts" mean time and money saved, and to the Service Man "time saved" means money earned.
This book is a compilation of important radio kinks and wrinkles and discusses only such items as are constantly used today.

**Book No. 8
RADIO QUESTIONS
AND ANSWERS**
A Selection of the Most Important of 5,000 Questions Submitted by Radio Men During the Course of One Year
By R. D. WASHBURNE
There have been collected a wide variety of questions which have come into our editorial offices during the past two years, and only those whose answers would benefit the majority of men engaged in radio have been incorporated in this amazing question and answer book. A tremendously long list of topics is treated.

**Book No. 9
AUTOMOBILE RADIO
AND SERVICING**
A Complete Treatise on the Subject Covering All Phases from Installing to Servicing and Maintenance
By LOUIS MARTIN
Automobile radios are up and coming, and someone has to service them properly. It therefore behooves you to read this immensely important new book on the art of Automobile Radio. The book is concise, and full of illustrations, photographs, diagrams and hookups.
A few of the really interesting chapters: Introduction; Automotive Radio Installations; Complete Descriptions of Commercial Automotive Receivers; Servicing Automotive Receivers; The Ignition System; General Service Considerations; Effects of Temperature on Power Supply; Conclusion.

**Book No. 10
HOME RECORDING
AND ALL ABOUT IT**
A Complete Treatise on Instantaneous Recordings, Microphones, Recorders, Amplifiers, Commercial Machines, Servicing, etc.
By GEORGE J. SALIBA
If there is one subject that is fascinating to every radio man, it is that of Home Recording. Of course, this volume is not all on "Home" recording, but the information contained therein is important to commercial radio men, studio operators, engineers and others interested in this phase of radio.
The art of recording and reproducing broadcast selections is becoming more important every day to radio men, experimenters and Service Men. Equipping dance halls, auditoriums, churches, restaurants and homes with public address systems and amplifiers brings many extra dollars and often an excellent income.

**BIG
DISCOUNT
OFFERED**

In order to make it possible for everyone to buy these books, the fifty (50) cent price has been made uniform for all volumes. You can buy these books separately, but you should take advantage of our special offer:

**When Five (5) Books
or More Are Ordered
Deduct 20%**
from Your Remittance

Simply fill in the coupon below, and mail it to us together with your remittance. Checks, stamps or money orders accepted.

**ALL BOOKS
UNIFORM**

The books in the new RADIO-CRAFT LIBRARY are all strictly up-to-date, and written by men who know their subjects. The volumes are all uniform size, 6x9 inches, and contain on an average of 50 to 120 illustrations. Each book is printed on the book paper, and no expense has been spared to make it an outstanding value, for its editorial contents as well as from the mechanical standpoint.

Clip Coupon and Mail Today!

GERNSBACK PUBLICATIONS, INC., 96-98 Park Place, New York, N. Y.

I have circled below the numbers of books in the RADIO-CRAFT LIBRARY, which you are to send me, and have deducted 20% for ordering five (5) books or more. I have included my remittance in full, at the price of 50c each, when less than five books are ordered.

The amount of my remittance is.....(Stamps, checks or money orders accepted.)
Circle numbers wanted: 1 2 3 4 5 6 7 8 9 10

Name Address

City State RC-12-32



AUDIO OSCILLATION

(Continued from page 343)

C1 and C2 were not present, the plate voltage applied to V1 would vary as the plate current of V2. Every time the plate current of V2 increased due to a signal, the voltage drop across R1 would increase, decreasing the actual voltage applied to the tube, which decrease would be in phase with the fluctuating plate potential due to the signal.

The result is that the signal is augmented because of the plate current of another tube, and if conditions are correct, the amplifier oscillates or, in some cases, "motorboats." The remedy is to completely isolate the plate circuit so that the A. C. component does not roam outside the bounds of the particular stage. Isolation is accomplished by means of resistors or chokes and condensers. Since the same reasoning holds true for the grid as well as the plate circuit, Fig. 1B represents a completely isolated or filtered stage.

It should be particularly noted that in a push-pull stage of an amplifier, no filtering is necessary, not even a bypass condenser for the grid bias resistor, since the plate currents of the two tubes are 180 degrees out-of-phase, and consequently cancel.

Microphone-to-Speaker Feedback

In P. A. systems where the microphone and speaker are placed in the same room, audio oscillations are bound to result. In this case the oscillations are not due to any fault of the amplifier (provided it does not oscillate with the microphone disconnected), but to the physical location of the loudspeaker with respect to the microphone.

The usual sequence of operation is as follows: The amplifier is turned "on" and the microphone current adjusted. In a little while, or perhaps immediately, a beautiful musical howl begins, starting at a low level and increasing in strength

as time goes on. Any attempt to speak into the microphone is useless as the tubes are overloaded far beyond their capacity—little or no output results. After much cut and trying, the microphone usually finds its way beneath heaps of overcoats, blankets, hats, rags, etc., with the announcer's head buried in close proximity to the microphone. Now, most of the uncertainty can be minimized if the proper precautions are taken regarding the placement of the units.

Oscillation takes place because a small amount of sound coming from the speaker, because of some minute disturbance in the microphone circuit, is fed back into the microphone, amplified, fed back again, etc., in the manner previously described. This may easily be demonstrated by holding the receiver of a home telephone close to its microphone. The only way to stop the oscillation is to prevent the sound from the speaker from reaching the microphone with any appreciable amplitude. Consider the simple sketch of Fig. 2A.

The sound that is directly emitted from the speaker is called the *incident* sound and, let us say, is radiated from the speaker as shown. If the microphone and amplifier is located in the open air so that the incident sound waves are not reflected by walls, buildings, etc., no oscillation will result.

Suppose, for instance, that the same setup is used but a large vibrant wall (like brick, stone, etc.) is erected in front of the speaker. Part of the incident sound wave will then be reflected by the wall, and if a double-button microphone is used, this *reflected* sound will enter the microphone and, if strong enough, cause oscillation. This idea is depicted in Fig. 2B. Sound waves act like light waves (acting on a mirror) in that the angle of incidence equals the angle of reflection. Hence, with the arrangement of Fig.

(Continued on page 378)

Remote Control



WARD LEONARD
MIDGET
REMOTE CONTROL

RELAYS

Working equipment may be hidden in the cellar or attic. You send and receive from any room. Only slightly units exposed to view.

Circular now ready. Send for your FREE copy.

WARD LEONARD ELECTRIC CO.

41 South Street, Mount Vernon, N. Y.

Please send me a free copy of your latest bulletin on Midget Remote Control Relays.

Name
Street
City and State
Call Signal

A TRIPLE-TWIN S.W. RECEIVER

(Continued from page 357)

Mechanical Construction

The physical layout conforms to the ideas stated. From left to right, Fig. A, there are the R.F. tuner and tube, the detector tuner and tube, the first A.F. stage, the second A.F. stage and the rectifier. The speaker connection socket is mounted on the right rear side; the aerial and ground posts are on the left rear side.

The method of ganging the R.F. and detector coils is extremely simple: two drums are mounted on each shaft. A soft copper band, 1/2-inch in width, is so fastened that both shafts rotate in the same directions. A shaft couple is attached to one coil shaft which provides single control for both coils. As both coil forms are identical, there can be no chance of incorrect hookup. The system of ganging is shown in Figs. 2A and 2B.

All high-voltage leads must be heavily insulated to prevent short circuits. Connections should be as short as possible. All negative connections can be made directly to the grounded chassis which is at a negative potential. For best results, it is recommended that the accompanying parts list be thoroughly followed.

List of Parts

Two Gen-Win short-wave tuners, wired as shown in Fig. 2A and 2B, L1, L2;
One Hammarlund MC-140-M dual condenser, C1;
One Dubilier 1 mf. type PL 300 condenser, C2;
One Dubilier 0.5-mf. type PL 3006 condenser, C3;
One Dubilier .02-mf. mica condenser, C4;
One .015-mf. mica condenser, C5;
One Hammarlund type EC-35 condenser, C6;
One Dubilier .001-mf. mica condenser, C7;
One Dubilier 2 mf. type PL 3008 condenser, C8;
One Dubilier 25 mf. type PL 4628 condenser, C9;
Two Dubilier 8 mf. type PL 3862 condensers, C10;
One I.R.C. Durham 500-ohm 2 watt Type ME 4 resistor, R1;
One I.R.C. Durham 5-meg. grid leak Type ME 4 resistor, R2;
One I.R.C. Durham 3000-ohm 2 watt Type ME 4 resistor, R3;

One I.R.C. Durham 1,500-ohm 2 watt Type ME 4 resistor, R4;
One I.R.C. Durham 12,500-ohm 2 watt Type ME 4 resistor, R5;
One I.R.C. Durham 250-ohm 2 watt Type ME 4 resistor, R6;
One I.R.C. Durham 70-ohm 2 watt Type ME 4 resistor, R7;
One I.R.C. Durham 5,000-ohm 2 watt Type ME 4 resistor, R8;
One I.R.C. Durham 3,000-ohm 2 watt Type ME 4 resistor, R9;
One I.R.C. Durham 3,500-ohm 2 watt Type 4 resistor, R10;
One Centralab 2,000-ohm potentiometer, R11;
One Centralab 200,000-ohm potentiometer, R12;
One Centralab 20-ohm center-tapped resistor, R13;
One I.R.C. Durham resistor, .1-meg., R14;
Two Sangamo Type AX 3-to-1 ratio A.F. transformers, T1, T2;
One Kenyon output transformer, pri. impedance 4,000 ohms, T3;
One Kenyon power transformer type B245 PT, T4;
One 3 mh. 250 ma. R.F. choke, X;
Two Hammarlund R.F. chokes type S.P.C., CH1 and CH2;
One Kenyon 30 hy. 125 ma. choke, CH3;
One dynamic reproducer field coil, CH4;
One Kenyon 20 hy., 25 ma. choke, CH5;
One Speed type 258 R.F. pentode tube, V1;
Two Speed type 256 detector and amplifier tubes, V2 and V3;
One Speed type 295 triple-twin amplifier tube, V4;
One Speed type 280 rectifier tube, V5;
Two Blan aluminum coil-shields, length 5 1/2 ins., width 4 3/4 ins., height 4 1/4 ins.;
One Blan aluminum chassis 21x10 1/2 x3 ins.;
One Blan aluminum dial-panel 4 1/2 x7 ins.;
One Blan aluminum switch-panel 2x3 ins.;
One Blan aluminum volume-control-panel 2x3 ins.;
One National vernier tuning dial, type VND-400;
One off-on switch, S1;
One speaker socket, S2;
Two drums to fit 1/4-in. shaft;
One copper belt 18x 1/2-in., wire, hardware, etc.

SHALLCROSS

No. 651



RADIO SET TESTER

For 4-5-6- and 7-prong tubes

This new circuit makes it possible for the service man to construct a light weight and compact up to date radio set tester for all tubes and radio sets in general use. It uses a special set of Shallcross Super Akra-Ohm Wire-Wound Resistors.
Send 6c in stamps for Bulletin 161P containing wiring diagram, construction details, and operating chart.



COSMIC QUALITY CONDENSERS



Manufactured by one of the greatest condenser organizations. Accepted as standard by set manufacturers. Built in strict accordance with R. M. A. and N. E. M. A. standards. Non-inductively wound, vacuum impregnated and hermetically sealed. Conservatively rated to insure long life and trouble-free performance. Thoroughly guaranteed against leakage, noise, and breakdown for one year. FREE REPLACEMENT.

REAL "BUYS" AT THESE LOW PRICES



By-Pass



Cartridge



Filter

COSMIC CARTRIDGE CONDENSERS

CAP. MFD.	D.C. VOLTS	NET PRICE	CAP. MFD.	D.C. VOLTS	NET PRICE
.01	200	9c	.01	400	10c
.1	200	9c	.1	400	12c
.25	200	11c	.25	400	15c
.5	200	15c	.5	400	22c
1.	200	19c	1.	400	29c

COSMIC BY-PASS CONDENSERS

CAP. MFD.	200 VOLT	400 VOLT	MULTIPLE-UNITS	
CAP. MFD.	Dual Section	Triple Section		
.1	17c	19c	.1	26c
.25	20c	24c	.25	31c
.5	25c	32c	.5	40c
1.	29c	43c	1.	52c
				66c

COSMIC FILTER CONDENSERS

CAP. MFD.	200 VOLT	400 VOLT	CAP. MFD.	600 VOLT	1000 VOLT
.25	12c	17c	.25	21c	39c
.5	15c	19c	.5	28c	49c
1.	21c	29c	1.	43c	69c
2.	33c	49c	2.	67c	\$1.20
4.	49c	87c	4.	\$1.15	\$1.85

SEND NO MONEY—Pay the Postman or remit in full and we pay the postage. Dealers, Servicemen and Experimenters send 3c stamp for our 1933 General Catalogue. Distributors and Jobbers write for proposition.

FACTORY DISTRIBUTORS

POSTAL RADIO CORP.

137 Liberty St. New York, N. Y.

QUALITY KENYON RELIABILITY



KENYON all-purpose amplifier components are the pride of exacting amplifier specialists.

KENYON audio, filter and power transformers may be purchased only from authorized dealers.

Name your favorite jobber and you will receive without any cost detailed schematic diagrams for heavy duty 845-50 watt, 250, 245, 48 D. C. and 46 class B power amplifiers.

KENYON TRANSFORMER CO., INC.
122-24 Cypress Ave., New York, N. Y.

AND NOW FLECHTHEIM SUPERIOR DRY ELECTROLYTIC CONDENSERS

Catalogue and Prices on Request

A. M. FLECHTHEIM & Co., Inc.
136 Liberty St., New York, N. Y.

REMOTE CONTROL

(Continued from page 363)

Let us observe the cut-off or discontinuance of operations. We press button Nos. 2 and 3. M3 is charged (of no consequence) and the M5 circuit breaker of contact M5 closes. This lead is in series with the circuit breaker on the regenerative unit, which is actuated only by button No. 3. As the two contacts are closed, current flows to relay magnet M2. and the armature disengages clips and the set is dead. To prevent complication of diagrams, the remote control indicators are not shown in the sketch, but are connected in series at point x. As will be noticed, telephone receivers are connected directly across button No. 3, controlling regeneration. This does not impair the operation in the least due to the high resistance of the phones.

"B" battery voltages from a power amplifier are impressed on the phones by use of a high-resistance transformer of the ordinary loudspeaker output type. As previously stated, pressing of button No. 1 actuates M4 and causes the rubber-tired wheel to engage the pulley, while button No. 2 charges M3 and the wheel engages the opposite pulley. This provided the clockwise and counter-clockwise movement of the variable condenser.

There is no limit to the sets of buttons one may use. In the case of the broadcast receivers, a set of buttons and a loudspeaker may be located in every room in the house and controlled at will. (However, there are such things as the man in the room below stealing your particular type of program.)

Suggestions and Summary

The layman and constructor may have around his shop only one set of 16 and 32 pitch worm and worm wheels of very fine pitch, which might suffice.

The slow motion of the tuning condenser is all that is required. As for the driving motor, this should be of the induction type. The writer used an induction fan motor, 110-volt, A. C., 1.100 R.P.M. A motor with a commutator will cause scratchy noises in the head-phones, unless the builder is adept in the art of choking it with blocking condensers.

One thing to remember is that all housings, bearings, hangers, motor shell, etc., must be grounded. That is, a lead soldered to each, brought together in one common lead, and soldered to the negative or "ground" lead of the receiver. If this is not done, loud noises will prevail in the telephone receivers, when working in the 20- and 40-meter bands.

For ordinary remote control within the dwelling, the operating voltage of 6 volts D. C. (from a storage battery) will be sufficient; as the distance is increased, the voltage should be stepped up. However, if it is contemplated locating the receiver a few miles away, sensitive relays of the "Pony Type" will be required, in addition to the rugged ones operating on 6 volts.

During extensive tests with the author's apparatus, it was found easier to tune stations on short waves than with the human hand on a 100:1 ratio vernier dial on the tuning condenser. With a motor turning 1.100 R.P.M., it takes 2½ minutes to run from minimum to maximum on the tuning condenser at the vernier ratio, and 48 seconds on the return. If one will turn the rubber tired wheel one rotation with his fingers, it amounts to approximately 1/12,000 part of an inch movement of the rotor plates of the variable condenser. When revolving at a moderate speed, and a station flops in, the shaft will continue to rotate about 2 R.P.M. or equivalent to 1/6,000 part of an inch. This is why the station stays "put"; and it is easy to tune from one station to another.

On the other hand, with the remote control unit adapted to the broadcast receiver, this is an ideal method of chasing up and down the scale; knowing that even distant stations may be brought in easily. It is believed this remote control unit will provide a greater "kick" to the average amateur, than any remote control transmitter he ever saw.

LIST OF PARTS

One ratchet wheel (from old alarm clock);
Three buzzer or bell magnets (double);

(Continued on page 379)

NASSAU · MIAMI HAVANA · CRUISES

\$115... 12¾ Days

Sight-seeing trips at each port, 3 days in Nassau, 2 days in Miami, 2½ days in Havana. Or take round-trip to Nassau only and stay 7 days at the Royal Victoria hotel for \$145.

Fortnightly sailings by S.S. Munargo on Saturdays.

BERMUDA

\$45 Round Trip

Twice weekly sailings, 21,000-ton S. S. Pan America and sister-ships. All airy, outside rooms mostly with beds and private baths. 5 days, including day at hotel in Bermuda, \$61; 7 days, \$73. S.S. Pan American goes direct to dock at Hamilton.

For information on the Free Trip Slogan Contest, see any Tourist Agent or write the Munson Line.

All sailings from Pier 64, North River, New York.

For further information see local tourist agent or

MUNSON

S. S. LINES

67 WALL ST., NEW YORK

Bowling Green 9-3300

In ST. LOUIS



THE AMERICAN HOTEL
275 ROOMS WITH BATH
\$2.00 UP



THE ANNEX
226 ROOMS WITH BATH
\$1.50 UP

The
AMERICAN HOTEL
MARKET AT SEVENTH

The
AMERICAN ANNEX
MARKET AT SIXTH

Our Food has made our Reputation
COFFEE SHOP OPEN UNTIL MIDNIGHT

A HOMEY HOTEL IN THE HEART OF NEW YORK

THE NEW FLANDERS

133 W. 47th Street through to 48th Street

One of the Finest Hotels in Times Square

Single Rooms with Adjacent Bath.....\$1.50 and up
Single Rooms with Bath 2.00 and up
Double Rooms with Bath 3.00 and up
Suite—2, 3, 4 People..... 5.00

Special Weekly Rates

FRED W. BIZEL, Resident Manager

CHEMISTRY

A New Plan to Become a TRAINED CHEMIST

\$6.25 By taking only one step at a time—as your means permit—STARTS YOU you can give yourself the benefit of the most complete, thorough-going, up-to-the-minute education for skilled well-paying professional work, in the most fascinating of all scientific fields, through our famous

COURSE IN PRACTICAL CHEMISTRY

Write TODAY For Information
Chemical Institute of New York, Inc.
Founded 1921
HOME EXTENSION DIVISION
19RC Park Place New York, N. Y.

TEST ADAPTERS

(Continued from page 365)

No. 955GG, Fig. 28, tests the 29 and 69 tubes. Models 17 and 19 test only the 29 tube; models AAA1, 40 and 400 series will test both the 29 and 69 with this adapter.

No. 965CG, Fig. 14, is used to test the 41, 42, PA and PZH tubes in the models 40 and AAA1 testers from the '36 socket.

No. 982 is used with the models 17, 19, 40, 400B and AAA1 testers to test the 82 and 83 tubes. Same as described for Fig. 12.

No. 954KGL tests the first section of a 93 or 95 triple-twin tube. Place in '27 socket of tester; used with the models 17, 19, 40, 400 series and AAA1 testers. Same as described for Fig. 22.

No. 954KG tests the second half of the 93 and 95 tubes. Same as described for Fig. 23.

No. 944PLCR tests the 866 tube in the models 17, 19, 40, 400B and AAA1 testers. Insert in 2.5-volt socket. Same as described for Fig. 24.

No. 944BRR is used to test the BR tube in the models 17, 19, 40, 400B, and AAA1 testers. Same as described for Fig. 29.

No. 944BRA is used to test the circuits of the BR tube. Used with the models 90, 99, 99+, 400, 400+, 400B and AAA1 testers. Same as described for Fig. 30.

No. 944BRB used in connection with the No. 944BRA adapter. Same as described for Fig. 31.

No. 944BHR is used to test the Raytheon BA and BH tubes in the models 17, 19, 40 and 400B testers. May also be used in pairs with the models 99, 99+, 400A, 400A+, and 400B testers. Same as described for Fig. 32.

No. 955KPT is used with models 40, 400B and AAA1 testers as output-meter adapter for pentode tubes. Same as described for Fig. 33.

No. 955SPT is used with the models 90, 400B, and AAA1 testers for output-meter connection across the plates of a 93 or 95 tube. Same as described for Fig. 34.

No. 965KS is used with the models 19, 40 and AAA1 testers to test the 57 and 58 tubes. Same as described for Fig. 16.

No. 975KP is used to test the 7-prong tube. Used with the models 17, 19, 40, 400B and AAA1 testers. Same as described for Fig. 35.

No. 950HS is the combination 4-socket adapter; used with the models 17, 19, 40, 400B and AAA1 testers. Same as described for Fig. 36.

No. 955DGLC, Fig. 45, is used with the models 99A and 400A testers for direct reading analysis of the 1st section of triple-twin tube circuits.

No. 954DP, Fig. 64, is used with all models of Supreme analyzers to obtain direct reading analysis of the 2nd section of triple-twin tube circuits.

No. 955GGKC, Fig. 47, enables direct analysis of the Wunderlich 5-prong tube circuits to be made with all models of Supreme analyzers when it is attached to the UY analyzer plug or its UY adapter and used in conjunction with the No. 955GGKL adapter.

No. 955GGKL, Fig. 48, is placed in the UY analyzer socket when the 5-prong Wunderlich tube circuits are to be analyzed.

No. 421X, Fig. 37, enables any Supreme plug or its UX adapter to be inserted in a WD11 socket.

No. 968, Fig. 38, enables a WD11 tube to be inserted in the UX socket of any Supreme analyzer.

No. 999, Fig. 39, is used on any Supreme plug or its UX adapter for its insertion into a UV199 socket.

No. 429, Fig. 40, is used in any Supreme analyzer UX socket to take a UV199 tube.

No. 419X, Fig. 42, enables any Supreme plug or its UX adapter to be inserted into a UV type socket.

No. 967, Fig. 43, enables any UV base tube to be placed into any Supreme UX type analyzer socket.

No. 949K, Fig. 4, enables any Supreme analyzer plug to have its filament prongs supplied with filament potential from a receiver using the overhead heater type tubes.

No. 932, Fig. 5, is used with the models 99A and 400A testers for analysis of 22, 32, 34 and 865 tube circuits.

No. 992, Fig. 6, is used with the models

(Continued on page 379)

2 GREAT BOOKS
THAT WILL BRING YOU MORE MONEY

RADIO PHYSICS COURSE \$3.50
by A. A. Chirardi
Authoritative in U.S.
Up-to-the-minute radio text book
includes 100 illustrations
Illustrated by Mr. Chirardi, Editor of Radio News and a radio instructor
992 pages
Over 500 illustrations

RADIO SERVICING COURSE \$1.50 Postpaid in U.S.
by B. M. Freed and A. A. Chirardi
Practical! Check full of the latest information and suggestions every service man needs in order to keep up to date! 192 pages, up to 100 illustrations. Valuable! Includes diagrams which show how to do things Over

MAIL THIS COUPON AT ONCE!

RADIO TECHNICAL PUBLISHING CO., R. C.-12
80 Fifth Ave., N. Y.

Enclosed find check, cash or money order for copies of the Radio Physics Course at \$3.50 each, and copies of the Radio Servicing Course at \$1.50 each. Check here for FREE circular....

NAME.....
ADDRESS.....
CITY..... STATE.....

SERVICE MEN TAKE NOTICE

J. R. Williams, E.E.,* originator and designer of such service instruments as the Supreme Diagonometer, Confidence English Reading Tube Tester, etc., is preparing complete and minute details on the construction and use of all types of service equipment—mostly new inventions. Nothing left out. Measurement drawings and detailed construction.

Within the next few months there will be such releases as Condenser Dielectric Leakage Tester, English Reading Tube Tester, "Resonator," a new method for peaking and aligning, etc.

You get this for \$2.00 a year.

Many months of research and design are behind each release and you will save over \$2.00 on each and every construction.

You will receive detailed construction data on complete large Central Service Station Test Boards. In fact, you will receive one release after another in such complete and concise detail you will be equipped with all necessary knowledge and drawings to build the latest and finest of all radio test equipment.

All of this for \$2.00 a year.

You will know the problems of each device. Nothing to guess about. The first release of an English Reading Tube Tester with all latest tubes is ready for distribution. Way ahead of anything. Next comes a real continuity tester and condenser leakage tester. No guess work as information is complete. Send your \$2.00 now to

J. R. WILLIAMS AND SONS,
519 Palm Street
Little Rock Arkansas
*Chief Engineer, Apparatus Design Company.

Makes Your Radio BEHAVE!



Do Your customers a favor by installing AMPERITE. Improves reception. Send \$1.40 to Dept. RC-12 for sample and sales help.

AMPERITE Corporation
561 BROADWAY, NEW YORK

AMPERITE

VOLTAGE CONTROL

BOOK REVIEWS

(Continued from page 361)

This book explains what qualities are needed in such R.F. amplifiers, how they are found in various tube constructions and how they are used in a number of practical radio circuits.

17 FR: *How A Vacuum Tube Acts as a Detector*: Between the audio and radio frequency amplifier tubes stands the important detector tube. This book covers such subjects as "Modulation and Demodulation," "Detector Operating Points," "Diode Detectors," "How to Calculate Audio Output," "Grid Leak and Condenser Detection," etc.

18 FR: *Screen-Grid, Variable Mu and Pentode Tubes*: This book covers such subjects as the purpose of the screen-grid tube, screen-grid tube construction and performance, coupling systems used in screen-grid amplifiers, the power pentode and variable mu tubes.

19 FR1: *Practical R.F. Circuits and Methods of Controlling Volume*: This book sums up and extends the description of radio circuits in previous books, and carries the reader from simple crystal detector circuits to regenerative circuits. It also deals with fixed and tuned R.F. receivers, bypass condensers and R.F. chokes, and cross modulation.

20 FR1: *The Radio Frequency Amplifier and How It Works*: An analysis of R.F. amplification is followed in this book by the correction of regeneration, the methods of suppressing oscillation, the elimination of magnetic inter-stage couplings; methods of shielding and R.F. coil problems.

21 FR: *The Vacuum Tube as a Generator in Radio Circuits*: The important problems of oscillation and modulation in radio circuits receive detailed attention here, with numerous graphs and diagrams. Typical oscillating circuits are presented and explained.

22 FR: *Tuners and Wave Filters*: This book covers the broad subject of selectivity in radio sets, how it is obtained and what difficulties are encountered. The uses of tuners, wave filters and coupled circuits for good selectivity are thoroughly discussed.

23 FR: *The Modern Superhetrodyne Re-*

ceiver: The theory of the reduction of high frequency radio signals to low frequency, with an analysis of the various parts of a superhetrodyne circuit, are presented in this book. Subjects covered are "Oscillators, Mixers and First Detector," "Intermediate Frequency Amplifiers," "Super-Regeneration," etc.

24 FR: *How to Select a Good Receiver*: The three tests for a radio receiver, sensitivity, selectivity and fidelity, are analyzed here. The significance of characteristic curves for these qualities is explained and tests are made for a number of standard radio receivers.

25 FR1: *Photocells and Glow Lamps*: This book describes the principles underlying another modern wonder tube—the photoelectric cell. Its characteristics, the various types, some photocell circuits and the theory and operation of glow lamps are covered.

26 FR: *Loudspeakers and How They Operate*: The various old and modern loudspeakers, including iron diaphragm units, balanced armature units, dynamic units, horn loudspeakers, together with their field of use and their limitations, form this book.

27 FR: *Loudspeakers, Tone and Output Control Devices*: Pursuing the question of loudspeakers, this book describes three quite modern types—the inductor dynamic speaker, the electrostatic, and the airplane cloth type. Tube-to-speaker coupling devices, loudspeaker response curves and methods of tone control are also included.

28 FR1: *Current Measuring Devices and Their Uses*: The operation, methods of construction, and calibration of ammeters, galvanometers and oscillographs are described in this book. Thermo-ammeters and thermocouples, magnetic vane electro-dynamometers and the oxide rectifier types are described.

29 FR1: *Voltage Measuring Devices and Their Uses*: This book describes various types of D.C. and A.C. voltmeters, including methods of high voltage measurements as well as vacuum tube voltage measurements. Sections are also devoted to the measurement of resistance and power.

30 FR: *Resistance, Capacity, Inductance and Frequency Measurements*: The use of the Wheatstone bridge, capacity and inductance bridges, measurements of frequency and wavelength and the use of oscillator and resonance meters are covered here.

31 FR: *Receiver Refinements*: This book goes into the subject of set design, covers the physical construction and requirements for condensers and outlines the requirements of a radio receiver that has simplicity of operation as well as positive control.

32 FR1: *Short Wave Receivers and Transmitters*: The new and growing field of short wave reception and transmission forms the basis of this book. The advantages of short wave apparatus, the detector circuit, short wave condensers and coils, the audio amplifier, the R.F. system, shielding the short wave receiver, and a number of short wave circuits for the designer are presented. Adjustment and operation of short wave receivers are also covered.

33 FR1: *Transmitting Antennas and Their Radiation Characteristics*: The antenna is the link between the transmitter and the receiver. The theory of antenna design, an analysis of ground and counterpoise systems, a description of antenna constants and antenna couplings, as well as the interesting operation of beam antennas, are among the subjects presented.

34 FR: *Design of Power Audio Amplifiers*: This book covers the problems that arise in the design and operation of various types of power amplifiers, covering both theory and practice. The methods of calculating the amount of amplification necessary to supply a definite amount of power for various loads are fully explained.

35 FR: *A Typical Broadcast Station*: This book takes the reader through each division of a modern broadcast studio, emphasizing the importance and particular role of each. It covers the studio, the monitoring control room, the master control room, the auxiliary equipment, etc., from the microphone into which the speaker talks to the antenna from which waves are radiated.

THOUSANDS OF RADIO MEN

Have asked for a book of this kind during the past year

The RADIO-CRAFT INDEX

It contains a thorough, alphabetical and topical arrangement of every article and subject which has been published in all the issues of RADIO-CRAFT from July, 1929 to June, 1932

RADIO Men have conclusively proved to us the need and practicability for a book which has included in it, a comprehensive and complete listing of every article which has thus far been published in RADIO-CRAFT. A book which has each topic so sub-divided and cross-indexed that a mere glance at a subject will give you any number of classifications and uses of it. For example, if you look at tubes, you find under this topic, various sub-titles, general, power, transmitting, photo-cells, testing of tubes, thyatron, etc. Every article or notice in the book has been considered so deeply important that when you refer to a certain classification, listed below the main topic, you will find perhaps a dozen or more articles treating the subject from different angles. The author

in each case is given—the exact issue in which the article appeared, and on what page it is to be found. So accurately compiled, by C. W. Palmer, one of radio's foremost writers, that in less than two minutes you can turn to any article—needless to wade through all the issues of RADIO-CRAFT which have been published during the past three years.

The RADIO-CRAFT INDEX is exactly the same size as the monthly magazine. It can be conveniently kept on file with the copies of the magazine—ready for quick reference. The index is printed on good paper with firm flexible covers to protect the inside. This book is sold only by the publishers at 25c the copy. Mail coupon below for your copy of the RADIO-CRAFT INDEX.

Briefly outlined below appears only a partial contents of the book

- | | | |
|-------------------------------------------------------------------------------------------------------------------------------------------------------------------------------------------------------------------------------------------------------------------------------------------------------------------------------------------------------------------------------------------------------------------------------------------------------------------------------------------------------------------------------------------------------------------------------------------------------------------------------------------------------------------------------------------------------------------------------------------------------------------------------------------------------------------------------|-----------------------------------------------------------------------------------------------------------------------------------------------------------------------------------------------------------------------------------------------------------------------------------------------------------------------------------------------------------------------------------------------------------------------------------------------------------------------------------------------------------------------------------------------------------------------------------------------------------------------------------------------------------------------------------------------------------------------------------------------------------------|---------------------------------------------------------------------------------------------------------------------------------------------------------------------------------------------------------------------------------------------------------------------------------------------------------------------------------------------------------------------------------------------------------------------------------------------------------------------------------------------------------------------------------------------------------------------------------------------------------------------------------------------------------------------|
| <p>AMPLIFIERS—
 General
 Audio Frequency
 Intermediate Frequency
 Power
 Radio Frequency</p> <p>ANTENNA SYSTEMS—</p> <p>CABINETS—</p> <p>CIRCUITS—
 Commercial
 Experimental</p> <p>CODE—</p> <p>COILS AND TUNING—</p> <p>COMPONENTS—</p> <p>COOPERATIVE LABORATORY—</p> <p>DETECTORS AND RECTIFIERS—</p> <p>EDUCATION—</p> <p>INTERFERENCE AND HUM</p> <p>ELIMINATION—</p> <p>KINKS—</p> <p>MANUFACTURING—</p> <p>METERS AND TESTING EQUIPMENT—</p> <p>MISCELLANEOUS—</p> <p>MOTION PICTURE RECORDING AND PROJECTION—</p> <p>MUSICAL INSTRUMENTS—</p> <p>NEUTRALIZING—</p> <p>NOVELTIES—</p> | <p>PATENTS—</p> <p>PHONOGRAPH REPRODUCTION AND RECORDING—</p> <p>POWER SUPPLY AND BATTERIES—</p> <p>RECEPTION—
 General
 Airplane
 Automotive
 Broadcast
 D. X.
 Short-Wave</p> <p>REMOTE CONTROL—</p> <p>SELLING AND MONEY MAKING</p> <p>SERVICING—
 General
 Equipment
 Operating Notes
 Service Men's Data</p> <p>SET CONSTRUCTION—
 All-Wave
 Automotive
 Broadcast
 Short-Wave</p> <p>SPEAKERS AND REPRODUCERS—</p> <p>TELEVISION—
 General
 Reception
 Transmission</p> | <p>TOPE AND VOLUME CONTROL—</p> <p>TOOLS—</p> <p>TRANSFORMERS—
 General
 Audio Frequency
 Intermediate Frequency
 Power</p> <p>TRANSMISSION—
 General
 Airplane
 Beam
 Broadcast
 Short-Wave</p> <p>TRANSMITTERS—
 General
 Airplane
 Amateur
 Broadcast</p> <p>TUBES—
 General
 Pentode
 Photo-Cells
 Testink
 Thyatron</p> <p>LIST OF BROADCAST, SHORT-WAVE AND TELEVISION STATIONS—</p> |
|-------------------------------------------------------------------------------------------------------------------------------------------------------------------------------------------------------------------------------------------------------------------------------------------------------------------------------------------------------------------------------------------------------------------------------------------------------------------------------------------------------------------------------------------------------------------------------------------------------------------------------------------------------------------------------------------------------------------------------------------------------------------------------------------------------------------------------|-----------------------------------------------------------------------------------------------------------------------------------------------------------------------------------------------------------------------------------------------------------------------------------------------------------------------------------------------------------------------------------------------------------------------------------------------------------------------------------------------------------------------------------------------------------------------------------------------------------------------------------------------------------------------------------------------------------------------------------------------------------------|---------------------------------------------------------------------------------------------------------------------------------------------------------------------------------------------------------------------------------------------------------------------------------------------------------------------------------------------------------------------------------------------------------------------------------------------------------------------------------------------------------------------------------------------------------------------------------------------------------------------------------------------------------------------|

ABSOLUTELY NOTHING WHICH HAS APPEARED IN RADIO-CRAFT HAS BEEN OMITTED FROM THIS VALUABLE COMPILATION

THIS BOOK CANNOT BE BOUGHT ON THE NEWSSTAND — ONLY DIRECT FROM THE PUBLISHERS

Clip and Mail Coupon TODAY!

Publishers of RADIO-CRAFT,
96-98 Park Place, New York, N. Y.

Enclosed you will find my remittance of 25c (check, stamps or money order accepted) for which you are to send me, postage prepaid, one copy of the RADIO-CRAFT INDEX.

Name

Address

City..... State..... RC



96 PAGES

OF NEW DATA
HAVE BEEN
ADDED TO THE

OFFICIAL REFRIGERATION SERVICE MANUAL

To bring this useful service manual right up-to-date, Mr. L. N. Wright, the editor of the OFFICIAL REFRIGERATION SERVICE MANUAL, has added a wealth of material on new electric refrigerators, and older models as well. As usual every refrigerator has been accurately described from the viewpoint of servicing—diagrams to illustrate the essential parts, so simplified that repairs can easily be made. The addition of these new pages will not increase the cost of the book to those who order their copy now.

Here Are Some Of The Important Chapters:
Introduction to the Refrigeration Servicing Business
History of Refrigeration Fundamentals of Refrigeration
Description of All Known Types of Refrigeration
Motors
Trouble Shooting
Unit Parts, Valves and Automatic Equipment
Makes and Specifications of Units
Manufacturers of Cabinets
Refrigerants and Automatic Equipment and Many Other Important Chapters

GERNSBACK PUBLICATIONS, Inc. RC-12
96-98 Park Place, New York, N. Y.

I enclose herewith my remittance for \$5.00 (check, stamps or Money Order accepted) for which you are to send me, postage prepaid, one copy of the OFFICIAL REFRIGERATION SERVICE MANUAL, together with the extra 96 pages of new material at no extra cost.

Name _____
Address _____
City _____ State _____

BOOK BARGAIN

Special Sale of

2000

S. GERNSBACK'S RADIO ENCYCLOPEDIA

1st Edition

WE HAVE on hand 2000 UNBOUND copies of this valuable book, and we are disposing of them at a price which does not even cover the cost of THE BOOK

69c

the paper and printing. The books are in first-class condition, sewed and stitched but unbound. You can put a cover on yourself or your bookbinder can do it at a very small expense. This indispensable radio reference book contains over 1,930 definitions, 549 photo reproductions, drawings, and diagrams. The size of the book is 9 by 12 inches. It contains 168 pages, and is printed on the finest book paper obtainable. Practically every definition in the book is illustrated, and all the subjects are arranged in alphabetical order with numerous tables and charts distributed throughout the text.

SEND NO MONEY NOW!

Do not send any money. We will send you the book and you may pay the postman 69c plus postage. Cut out coupon, paste on postal card, and mail to:

ISKOR PRESS, Inc., 19 Park Place,
New York, N. Y.

BARGAIN ORDER BLANK

ISKOR PRESS, Inc. RC
19 Park Place
New York, N. Y.

Please send me S. Gernsback's Radio Encyclopedia, 1st Edition, unbound. I will pay Postman 69c plus postage.

Name _____
Address _____
City _____ State _____

SHORT CUTS

(Continued from page 352)

A PLATE CIRCUIT ADAPTER

Jack S. Stanton

THE adapter illustrated in Fig. 3, when placed in a rectifier socket and the rectifier placed in the adapter, will enable the Service Man to work on a radio receiver power pack without getting a shock. Also, this adapter is a time saver since it permits pre-heating tubes, while the "B" supply circuit is opened by means of switch SW. Furthermore, this adapter may be used to tap the high voltage D.C. from the rectifier tube in the set, thereby providing an external "B" supply for demonstrating, for instance, a short-wave converter.

In the latter instance, a filter choke, condenser and voltage divider complete the "B" supply for the converter; two of the six wires in the adapter carry 5 volts for the rectifier filament and this potential may be used to operate a trouble light or as a positive lead of the high voltage D.C. for the converter while an additional wire, connected to the chassis of the set or the ground, provides a negative, high-voltage connection.

For the cable, the writer braided six 18 in. lengths of flexible, rubber-covered hookup wire. Strict care must be taken to maintain the high insulation necessary in devices operating at these high potential circuits.

A MULTIPLE CONTACT AND ANALYZER SWITCH

J. L. Henderson

NECESSITY, the mother of invention, accounts for the switch illustrated in Fig. 4. It was built in lieu of the three-gang six-pole switch called for in the article, "The RADIO-CRAFT Universal Analyzer," which appeared in the September, 1932 issue of RADIO-CRAFT.

The arrangement illustrated in Fig. 4 was built from a "junk box" and therefore does not carry dimensions. Needless to say, the arrangement comprises a few scraps of bakelite, two jack bridges and nuts, a heavy spring, a piece of 1/4-in. shaft, some spring copper, and 13 switch contact points, plus miscellaneous set screws and machine screws.

Tap the contact points into the bakelite to make a more solid job. Place the contacts close together in order to prevent the circuits being opened, thus damaging the meter movements during a change of position under load; finally, surface off the contacts with fine sandpaper glued to a board. The indicator knob is slotted to show one number at a time.

KINKS

(Continued from page 354)

HOW TO MAKE A TUNING FORK OSCILLATOR

C. W. Melotte

MANY technicians would like to measure the response of loudspeakers and A.F. amplifiers, but lack the necessary cash to build a reliable A.F. oscillator. Therefore, a description of an oscillator built by the writer along the lines of Fig. 4 may be of general interest. Since every tuning fork has a natural period of its own, a fork will be required for each test frequency; a complete set is not expensive. However, one fork may be adjusted to one of several frequencies, by means of sliding weights on the prong as shown at X in Fig. 4A. Forks may be purchased with accurate marks to show where to set the weights for different frequencies. The fork is set into vibration by tapping the key button, Fig. 4A.

Coil L is wound with No. 36 to 40 enam. wire on an iron-core form which will just fit inside of the individual tuning fork; of course, the ends of the core must clear the tines of the fork. The wire from a magnetic reproducer will be about right as to size and quantity.

The output of this inductance feeds into an A.F. amplifier; the connections for this unit are shown in Fig. 4B.

In Fig. 4C are shown the connections of a modulator. If this unit is used, its input connects to the output of the amplifier of Fig. 4B. The output of the modulator may be con-

(Continued on page 379)

Train Now for New RADIO Opportunities



Get Into a Line
Where There's
Action—Every Day
—And a Payday
Every Week—You be
the Boss!

**YOURS
Without
Extra Cost**

This excellent set analyzer and trouble shooter included with our course of training.

Right now while hundreds are looking for work where there isn't any, the radio service field can use trained men. With the proper training and the necessary equipment, you can enter this field and make a comfortable living. We include with our course this modern set analyzer and trouble shooter without any extra charge. This piece of equipment has proved to be a valuable help to our members. After a brief period of training, you can take the set analyzer out on service calls and really compete with "old timers." We show you how to wire rooms for radio—install auto sets—build and install short-wave receivers—analyze and repair all types of radio sets—and many other profitable jobs can be yours.

Teaching you this interesting work is our business and we have provided ourselves with every facility to help you learn quickly yet thoroughly. If you possess average intelligence and the desire to make real progress on your own merits, you will be interested.

ACT NOW—MAIL COUPON

Start this very minute! Send for full details of our plan and free booklet that explains how easily you can now cash in on radio quickly. Don't put it off! Write today! Send Now!

RADIO TRAINING ASSN. OF AMERICA.
Dept. RCA-12, 4513 Ravenswood Ave., Chicago, Ill.
Gentlemen: Send me details of your Enrollment Plan and information on how to learn to make real money in radio quick.

Name _____
Address _____
City _____ State _____

BACK ISSUES of RADIO-CRAFT can be had at the price of 25c each. Address RADIO-CRAFT, 98 Park Place, New York City.

SERVICEMEN! DEALERS! YOUR PROFIT GUIDE FREE! EVERYTHING NEW!



Send for your copy of the New Radolek Profit Guide to-day! Hundreds of new items at lowest wholesale prices makes Radio Servicing easier and more profitable. Dealers, Servicemen, Laboratory Heads and Manufacturers send coupon below with your letterhead or business card for free copy.

THE RADOLEK COMPANY
601 W. RANDOLPH ST.
CHICAGO, ILL.
Phone MONROE 5434

The RADOLEK CO., 119 Canal Station, Chicago, Ill.
Send Me the New Radolek Profit Guide

Name _____
Address _____
City _____ State _____
Do you do service work? Yes. No
Do you operate from Store, Shop or Home?
 Store or Shop. Home
What Testing Equipment have you?
What Training Course or experience?

Announcing!

An Entirely NEW SERVICE for all Radio Service Men

HERE is big news for every Radio Service Man. If you want diagrams of commercial radio receivers, we are now prepared to give you

RUSH SERVICE

In the three OFFICIAL RADIO SERVICE MANUALS published by us so far, we are listing almost 5,000 diagrams of commercial radio sets manufactured in America.

Heretofore, you could only get these diagrams by buying our OFFICIAL RADIO SERVICE MANUALS.

We have, however, had an increasing demand of late from Radio Service Men who are not necessarily owners of any of the MANUALS but who wish to get one or more diagrams. We are now prepared to send you such diagrams on a rush order plan. We realize that if you want one of these diagrams you want it quick.

For that reason, we now have a special staff to send any special diagram out to you the same day your order is received.

If you live a distance away from us, and cannot wait for the regular mail send us 8 cents extra, and the diagram will be sent to you by air mail.

These diagrams come to you on heavy bond paper, size 9x12. We are prepared to furnish you practically any diagram you can ask for IMMEDIATELY.

HOW TO ORDER

Just tell us what diagram you want, giving us the name of the radio set, and the model number. We will immediately mail you the diagram if it is available, the same day your order is received.

We have a uniform charge for this service and that is 25c for each radio diagram.

If you wish more than one diagram, the price is still 25c each, but if you order six at one time, the price will be \$1.00 for the six, providing all are ordered at one time.

GERNSBACK PUBLICATIONS, INC.

(Special Diagram Department)

96-98 PARK PLACE

NEW YORK, N. Y.

OSCILLATION

(Continued from page 373)

2B only a small amount of energy is fed back, which may be below the level required for oscillation to take place.

In the diagram of Fig. 3 which illustrates conditions in which the microphone and speaker are located in the same room, the microphone is shown as a black dot in order to simulate actual conditions.

A sound wave issuing from the speaker is reflected by the walls surrounding the speaker and ultimately finds its way back to the microphone; oscillation, therefore, results. Suppose, for example, it is not possible to change the location of either the microphone or speaker, but the oscillation must be eliminated, then what?

From the above considerations, we know that it is the energy in the reflected sound wave that ultimately reaches the microphone, causing oscillation. And since the positions of either the microphone or speaker cannot change (by hypotheses) the only resort we have is to reduce the energy in the reflected waves.

When a sound wave strikes a surface, it is either absorbed, or reflected. (Practically, of course, a little of either always happens, but in most cases, more of one than another.) If the sound wave is absorbed, then the reflected wave (if any) will be very weak; reverberation will be absent; and, the room will be "dead." If the sound wave is reflected, then the conditions described above will obtain—feedback, oscillation, etc. For this reason, it is well to line the walls of the room in which the microphone and amplifier are to be used with curtains, drapes, carpets, etc., or anything that will absorb sound—not reflect it to a great extent. In this manner, the energy in the reflected waves is reduced to a value which is just insufficient to cause oscillation.

It would be useless, of course, to place sound absorbing material on that part of the wall where the incident or reflected waves do not touch. The idea, then, is to trace the angle of the sound wave from the speaker and place the material on that portion of the wall where the

sound would strike. Pictured in this article is a sample of sound absorbing material manufactured by Ames, Aceves and King which resembles corrugated board and which has a high and uniform coefficient of absorption (ability to absorb sound).

It also sometimes happens that the microphone and the speaker may not be in the same room and yet audio oscillation results. The feedback, in this case, results from the transmission of the sound through the wall connecting the two rooms. The obvious remedy then, is to "treat" the wall causing the trouble. It is not a simple job for the layman to handle. Considerable patience and experience is sometimes required which will be well rewarded—if done properly.

BATTERY-OPERATED P.A. SYSTEM

(Continued from page 364)

- watt, (12);
- One Acratest carbon resistor, 500,000 ohms, 1 watt, (14);
- One Yaxley wire wound resistor, 2 ohms, (28);
- One Acratest cartridge type condenser, .03-mf., 300 volts, (13);
- Three five-prong wafer sockets, (15), (17), (18);
- One Acratest input class B transformer, No. 7127, (16);
- One Acratest output transformer, No. 7129, (19);
- One Acratest output terminal strip No. 7149, (20), (21), (22), (23), (24), (25);
- One Flechtheim filter condenser, 4 mf., 200 volts, D.C. type GB-400, (26);
- One Korrol chassis to specification;
- One Best magnetic speaker, 4,000-ohm impedance;
- One wooden carrying case;
- One ER type '32 tube;
- One ER type '33 tube;
- Two ER type 49 tubes;
- Three ER 45-volt "B" batteries;
- Two Eveready dry cells;
- One Eveready "C" battery, with 16.5-volt tap.

P.A. AMPLIFIERS

(Continued from page 353)

loudspeakers in the individual class rooms.

If the school auditorium is also the town meeting place and the center of political and social activities, you have even a stronger argument. Always emphasize the fact that speakers, entertainers, etc., do not have to exert themselves in order to fill the hall; they merely speak or sing in their natural voices and the P.A. unit does the rest. Play up the microphone stuff. The "mike" has a magic, irresistible attraction that rarely fails to "get" people who step in front of it.

You may wonder why factories are included on the list of prospects. The answer is that they represent a veritable gold mine. While many plants are running at reduced capacity, there are plenty that are still busy, and there never has been any let up in some lines. For creating and maintaining employee morale, particularly in factories where the work is monotonous, there is nothing like a P.A. system reproducing phonograph music through a few scattered loudspeakers. Numerous companies are using this scheme and are finding it highly effective, especially if the workers are women and girls.

The practice varies. Some factory managers keep the music running almost continually, at low volume, if the nature of the work does not require very great concentration. Others turn on a record every hour or so, and keep the system alive all during the lunch hour. The usual result is a factory full of smiling, singing people, who are likely to forget some of their troubles and do better work. An incidental value of such a P.A. system is for summoning executives to the telephone and for making announcements in general.

As in other fields of salesmanship, nothing is as effective as a demonstration. In the case of P.A. amplifiers you can "make them talk for themselves." People who have had no experience with such devices do not fully appreciate their possibilities, and they must be made to talk into a mike and hear some real phonograph music. This means you must have an amplifier available and must be prepared to demonstrate it on the prospects' own ground or in some other easily accessible place. You must not expect a man to buy something "sight unseen," or rather "sound unheard," in this case. Your purchase of one amplifier to start with represents your investment in a business. Once you have installed the first job you can then bring prospects around to hear it under actual working conditions, and things will be easier from then on.

Make sure the local papers know about that first installation. They are always anxious to get local news and may be able to give you extremely valuable publicity. Don't be modest; call 'em up and tell them all about it. If you don't blow your own horn no one else will.

As an example of the many excellent amplifiers that Service Men can obtain, the new Lafayette class "B" 28-watt job is representative. It makes use of one of the new type 57 tubes, three type 46 and one type 83 mercury vapor rectifier, in the unusual circuit shown. The input, from microphone, phonograph or radio, is lead to the grid side of the 57. This tube is directly coupled to a 46 by the well known Loftin-White method, the 46 in turn feeding two more 46's in a push-pull output stage. The output of this compact outfit, which measures only 11½ by 20 by 8 inches, is sufficient to drive TWENTY full size dynamic speakers.

The schematic diagram and the accompanying illustration will give the Service Man a complete technical story on this versatile amplifier. To accommodate various combinations of speakers and lengths of lines, the secondary of the output transformer is tapped in two sections to give output impedances of 4, 8, 15, 500 and 2,000 ohms.

In forthcoming articles the writer will discuss permanent outdoor installations, mobile, portable and temporary installations, inter-office systems and incidental technical problems such as line matching, acoustic feed back, use and care of accessories, etc. If any Service Man is confronted with an immediate problem in any of these classifications the writer will be glad to correspond with him and offer all possible assistance.

NEW TUBES

(Continued from page 367)

The following details obtain for the 59: Heater voltage, 2.5; heater current, 2 amp. In the following data the first numeral refers to a class A triode, the second to the pentode connection, and the third to the class B connection: Plate voltage, 250, 250, 400; control-grid voltage, -28, -18, 0; screen-grid voltage —, 250 volts, —; plate current, 30 ma., 35 ma., 15 ma. (no signal); amplification factor, 6, 6, 6; load impedance, 5,000 ohms, 7,000 ohms, 1,500 ohms; output, 1.25 watts, 2.5 watts, 20 watts (maximum for two tubes).

A curve showing the relative distortions present for three different connections is shown in Fig. 7.

TUNING CONTROL

(Continued from page 374)

- Four buzzer or bell magnets (single);
- One induction motor;
- Four adjustable hangers, with bearings ($\frac{1}{8}$ hole);
- Eight inches of $\frac{1}{8}$ in. steel shaft;
- Three collars, $\frac{1}{8}$ in. hole;
- One grooved pulley, 1 in. or more, $\frac{1}{8}$ in. hole;
- One grooved pulley, $\frac{1}{2}$ in. or more, $\frac{1}{8}$ in. hole;
- Two flat faced pulleys, $1\frac{1}{2}$ in., $\frac{1}{8}$ in. hole (diameter of pulley-optional);
- One worm gear, 16 pitch, $\frac{1}{4}$ in. hole;
- One worm wheel, 16 pitch, $\frac{1}{4}$ in. hole;
- One worm gear, 32 pitch, $\frac{1}{4}$ in. hole;
- One worm wheel, 32 pitch, $\frac{1}{4}$ in. hole;
- One length $\frac{1}{4}$ in. diameter steel shaft;
- One reducing gear, 10 to 1 ratio (spur gears);
- One sprocket gear, 1 inch, $\frac{1}{8}$ -in. hole;
- One sprocket gear, $\frac{1}{2}$ in. (to fit motor shaft);
- One length (12 inches approximate) chain.

ADAPTERS

(Continued from page 375)

- 99A and 400A testers for analysis of '24, '35, '36, '38, '39, 44 and '51 tube circuits.
- No. 974, Fig. 7, is used with models 99A, 99A+, 400A, 400A+ and 400B for analysis of 33, 46, 47, GA, LA and PZ circuits.
- No. 965SS, Fig. 81, is used with the model AAA1 tester being attached to the analyzer plug and No. 965SL is used to hold a 6-prong tube in the 5-prong analyzer socket for circuit tests of 29, 41, 42, 55, 57, 58, 69, 85, 89, PA, PZH and Wunderlich tubes.
- No. 946SS1H, Fig. 82, is used with the model 90 series, 1J, and 2J and also model 400B-N4 testers series for attachment to the analyzer plug. Used in conjunction with the No. 965SL adapter which is used in the 5-prong analyzer socket while making circuit analysis of 29, 41, 42, 55, 57, 58, 69, 85, 89, PA, PZH and Wunderlich tubes.
- No. 946SS Fig. 83, is used with the model 90, series 3J, 4J, and 5J testers for attachment to the analyzer plug. Used with the No. 965SL adapter which is placed in the 5-prong analyzer socket for analyzing the circuits of 29, 41, 42, 55, 57, 58, 69, 85, 87, PA, PZH and Wunderlich tubes.

KINKS

(Continued from page 377)

nected in series with the plate-circuit power supply to an R.F. service oscillator. Qualitative tests may be made by ear; quantitative values may be obtained by connecting a V.T. voltmeter across the output of the A.F. amplifier.

Be sure that the low-ratio A.F. transformers, T1 and T2, are of high-efficiency type.

"MIKE AND IKE—"

There are thirty million radios in the United States. Mike country, may she never be wrong! Mike country, may she always be right! But right or wrong Mike country!—H. I. Phillips (N. Y. Sun).

A STATEMENT By Hugo Gernsback

I HAVE been publishing radio magazines since 1908, and during this period I have learned to know what radio readers want.

Last summer I made a trip through central Europe. In order to acquaint myself with radio conditions as they are in Europe today, I was amazed at the tremendous amount of radio experimenting that is now going on, in practically all of the western European countries. I found conditions similar to those during the 1921-1923 boom in America. Radio stores were prospering and doing a land-office business. The reason, of course, is the intense interest of the European radio experimenters who are building sets on a scale undreamt of before.

The European radio publications are abounding with new circuits and new radio developments that have found their way slowly over to the United States. The reason is that, since there is such a tremendous amount of original radio engineering going on in this country, there has been no publication that catered to the foreign development. All the American radio publications must, of necessity, report the American activities first and, as a rule, have no room left for what is going on in Europe unless an epoch-making development appears.

I therefore conceived the idea of bringing to my American readers a totally different radio publication, the like of which has never been published before; and the result is RADIO REVIEW AND TELEVISION NEWS.

This is not entirely a new magazine; it is, really, two magazines in one. A section devoted to television has been retained, which will report in every issue, the major American and European television advances; but the big, front section is given over to an international radio digest. This magazine, therefore, will perform the function that, for instance, the LITTELLARY DIGEST is serving in literature. You may not be aware of the fact that there are some 140 radio publications printed outside of the United States; but from all of these publications RADIO REVIEW is extracting the best—the Radio Meat—which you want.

There are literally thousands of new circuits, due to the new tubes, and there is so much new material for the experimenter that I would have to fill several pages to tell you all about it.

RADIO REVIEW AND TELEVISION NEWS then is a new mirror, which will accurately show you a true perspective of what is going on in radio all over the world, and will give you material in such profusion as you never have seen before. Hundreds of new radio hook-ups, special circuits, new time-saving kinks, new money-making ideas galore. You will find here the latest radio circuits and sets from France, Germany, England, Italy, Russia, Norway and even Japan.

Dozens of translators have been busy to make the first issue of the new combination magazine a memorable one, that you will not soon forget, and you will wonder why I hadn't done it before.

And now I will ask you for a favor. Go to the nearest newsstand and get a copy of RADIO REVIEW AND TELEVISION NEWS.

Pay your quarter for it, go home and look it over. If at the end of a week, you find that for any reason you do not like the magazine, return it to me with a letter stating why you don't want it and I will refund your quarter, so sure am I that you will not wish to be without this magazine in the future.

Remember, you don't have to pay for the magazine unless you think it is what you are looking for.

If your newsdealer is sold out or does not stock the magazine, send 25c to us (see coupon) money refunded if you don't want the magazine.

I thank you in advance for your patience and for your confidence.

Cordially yours,

Hugo Gernsback

A few of the outstanding articles in the RADIO REVIEW section:

NEW: Play Music on Your Radio Set; Build the sensational THERMIN ADAPTER

- 1 Tube D.C. Power-Loudspeaker Special
- The VM-Three Receiver
- The Diode Screen-Grid Circuit
- Improved Reinartz Hook-Up
- Preventing Radiation from the Local Oscillator
- New Transmitting Antenna Decreases "Skip Zone"
- The Champion Three—a Prize French Receiver
- Adding Automatic Volume Control
- A D.C. Super-Heterodyne
- Locating Hidden Pipes by Radio
- One Tube Super-Regenerative Loop Receiver
- A Two for 7 Meters
- Review of American Radio Literature
- Digest of American and Foreign Patents
- Dozens of Circuits, Kinks and Practical Suggestions

Features in TELEVISION NEWS section:

- A Combination Sight and Sound Receiver
- A 5-Meter Super-Regenerative Television Receiver
- New Baird Television Built Like Camera
- Television Transmitter for Topical Events
- Diode Detection for Television Receivers
- Myers Mercury Vapor Television Lamp
- Schedule of Active Television Stations
- Television Question Box

**YOU NEED NOT
PAY FOR THIS
MAGAZINE IF
YOU DON'T LIKE
IT. YOU ARE
THE SOLE JUDGE**

IMPORTANT

Do not confuse the former TELEVISION NEWS with this magazine. RADIO REVIEW AND TELEVISION NEWS are two distinct magazines in one.

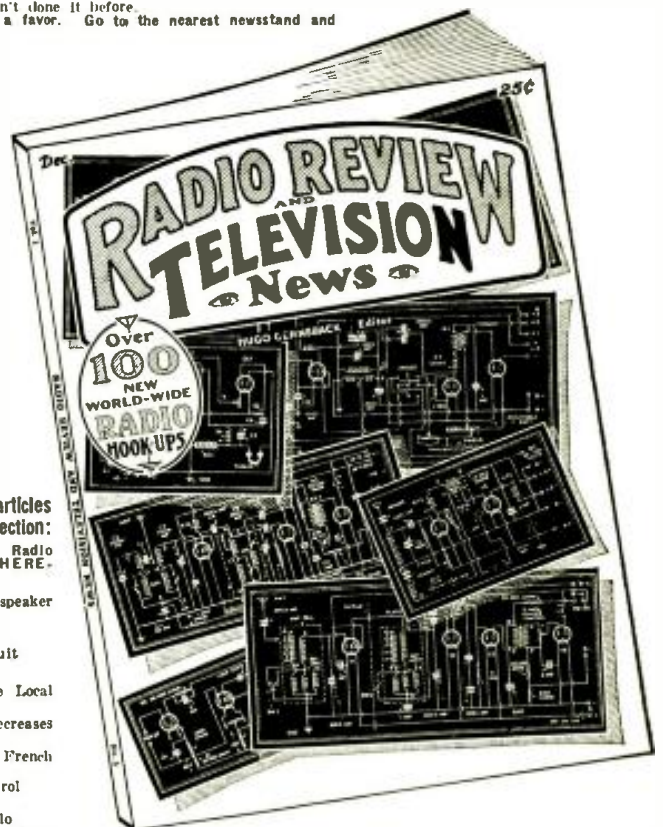

RADIO REVIEW AND TELEVISION NEWS
98 Park Place RC-12-32
New York City (Mark X in Square Which Offer You Desire)
Gentlemen:

As per your special offer, I enclose \$1.25 (Canada and Foreign \$1.50) for which enter my subscription to RADIO REVIEW AND TELEVISION NEWS for one year Send me the current issue of RADIO REVIEW AND TELEVISION NEWS, for which I enclose 25c (U. S. stamps or coin accepted) with the full understanding that if I do not like the magazine you will refund the money as explained above

Name

Address

City and State

On this page are listed manufacturers' catalogs and booklets, chosen because they are of interest to readers of RADIO-CRAFT. You can obtain copies FREE by using the coupon below.

5. **CLAROSTAT CONTROL HANDBOOK.** A large 32-page book containing detailed specifications of volume controls, attenuators, constant-impedance controls, phonograph pickup faders, tone controls, line ballasts, rheostats, potentiometers and fixed resistors of various kinds, together with valuable circuit-design data. Contains many diagrams and charts, and a guide of replacement volume and tone controls for many commercial receivers. *Clarostat Manufacturing Company, Inc.*

7. **SPEED RADIO TUBES.** Contains a chart of the electrical characteristics of the Speed tubes, and also a convenient list of broadcasting stations with space for dial settings. *Cable Radio Tube Corporation.*

8. **ELECTRAD PRODUCTS.** Descriptions of the full line of Electrad volume controls, voltage dividers, vitreous resistors, Truvolt adjustable resistors, amplifiers and other devices for radio and electrical applications. Among other diagrams, it includes twenty-four circuits showing the placement of volume controls in different types of broadcast receivers. *Electrad, Inc.*

9. **RECTIFIER TYPE INSTRUMENTS.** This type of instrument is used principally for measuring alternating currents of such small magnitude that they cannot be measured readily with ordinary types of A.C. instruments. It consists of a sensitive D.C. meter used in conjunction with a rectifier made of four sets of copper-oxide disks arranged in the four arms of a Wheatstone bridge circuit. This folder, written by the chief engineer of the Weston company, describes the principles of operation, and is very interesting and instructive. *Weston Electrical Instrument Corporation.*

11. **SUPREME INSTRUMENTS.** Contains lengthy descriptions of the Supreme service instruments, including the AAA1 Diagonometer, which is five instruments in one, the model 90 analyzer, the model 40 tube tester and the models 60 and 70 oscillators. Interesting to the Service Man because it tells how his work is facilitated by ingeniously-designed test equipment that indicates the condition of an entire set in a few minutes. New test apparatus to take care of the new tubes is also described. *Supreme Instrument Corporation.*

19. **A BAPTISM OF FIRE.** Centralab fixed resistors are made by forcing a carefully calibrated resistance material through a plastic ceramic material, and then baking both under terrific heat. This booklet describes the manufacturing process in detail, and lists the advantages claimed for fixed resistors of this type. It is interestingly written and illustrated, and makes good reading. *Central Radio Laboratories, Inc.*

21. **READRITE RADIO INSTRUMENTS.** This sixteen-page pamphlet contains some valuable hints on the testing of electrolytic condensers, as well as descriptions of the full line of popular-priced Readrite instruments. Worth having. *Readrite Meter Works.*

25. **AEROVOX 1932 CONDENSER AND RESISTOR MANUAL AND CATALOG.** This 48-page booklet is worth having and saving. In addition to very complete specifications on the full line of Aerovox paper, mica and electrolytic condensers, and vitreous enamel, carbon and wire-bound resistors, it contains a great deal of information and data on condensers and resistors in general which the Service Man and experimenter will be able to apply to his everyday problems. *Aerovox Wireless Corporation.*

27. **DUBILIER CONDENSERS.** The name Dubilier being synonymous with condensers in the minds of many people, the latest catalog of Dubilier condensers is sure to be of interest to all classes of radio users. This 16-page booklet describes the entire line of receiving condensers and tells something of the historical background of the company. The special service kit and replacement units are recommended to the attention of Service Men. Included with the catalog is an instructive technical article dealing with electrolytic condensers. *Dubilier Condenser Corporation.*

28. **HAMMARLUND PRECISION PRODUCTS.** Midget variable condensers and their numerous applications in short-wave and broadcast receivers are discussed in a folder accompanying the complete catalog of Hammarlund variable condensers and coils. Some excellent circuit kinks are given. The catalog contains dimensional drawings of the popular Hammarlund midgets which may be of assistance to constructors designing small re-

ceivers. *Hammarlund Manufacturing Company, Inc.*

55. **PHILCO PARTS CATALOG.** This new catalog will undoubtedly be of great help to all radio Service Men because it contains the only official, complete list of the more common replacement parts used in every Philco receiver from the very beginning of the company to the present time. The manufacturers are anxious to cooperate with Service Men and offer this catalog to all who want it. *Philco Radio & Television Corp.*

59. **PRACTICAL RADIO ENGINEERING.** This handsomely prepared 24-page brochure describes in great detail the home-study courses in radio engineering offered by the school mentioned below. These are intended for the more advanced type of student who is interested in actual radio engineering, as they include mathematics running up to vector analysis, use of the slide rule, and even the operation of 50-kilowatt broadcasting stations. The instruction is intended to bridge the gap between college study which emphasizes the theoretical side and the "practical" courses which end with service work. The serious radio man who is looking ahead will find this booklet worth reading. *Capitol Radio Engineering Institute.*

63. **THE AKAFORMER.** The Akaformer, described in this folder, is a coupling device that hooks right on to the aerial wire, and connects to the set through a shielded down lead. The combination tends to reduce noise in the set picked up by the usual lead in, which, running along the side of the building, is more readily affected by elevator motors, vacuum cleaners, dentists' drills and other electrical machinery than the flat top section of the aerial proper. The device is inexpensive and is easily installed, and is thereby a very profitable item for Service Men located in districts where artificial noise is very troublesome. *Amv. Aceves & King, Inc.*

64. **SYLVANIA RADIO TUBES.** So many new tubes have appeared during the past several months that tube charts printed as recently as the Spring are incomplete and therefore of little value for reference purposes. Readers desiring new and complete charts for their shop wall will find the new Sylvania chart very desirable. It measures 11 by 17 inches when unfolded and shows bottom views of the tube bases in addition to full average characteristics of old tubes dating back to the 199 and 200A and all the new tubes including the latest 6.3 and 2.5 volt types. Special mention is made of the 56, 57, 68, 46, and 82 tubes; complete data are also given on the 38, 41, 69, 42 and 44. *Hygrade Sylvania Corporation.*

66. **WHOLESALE RADIO SERVICE CATALOG.** The 1932 Spring and Summer Radio Catalog of the Wholesale Radio Service Company is the kind of catalog the radio Service Man and experimenter will carry around with him all the time in his back pocket. Measuring 7 by 10 1/4 inches and containing 100 pages, it is one of the most complete catalogs we have ever seen. It includes everything from soldering lugs to all-wave combinations, and is of particular value to the Service Man because of its handy lists of replacement parts for standard receivers. *Wholesale Radio Service Company, Inc.*

77. **SAMSON MICROPHONES AND ACCESSORIES.** The well-known line of Samson "PAM" amplifiers is now being supplemented by a series of high quality microphones and accessories, which are described in a bulletin which gives their technical characteristics. The first seven "mikes" are of the double-carbon-button type. Four of these are intended for suspension in the familiar ring stand, two are of the hand type, and the last resembles an ordinary desk telephone. The second group comprises three dynamic microphones, which use the same unit in different forms of mounting. The third and last group is a pair of condenser "mikes" designed for broadcasting purposes. All these microphones are of interest to public address and broadcasting specialists. *Samson Electric Company.*

80. **FLECHTHEIM CONDENSERS.** A wide variety of fixed condensers, ranging from tiny midgets, the size of postage stamps, to heavy transmitting units a foot high, are described and illustrated in the latest Flechtheim catalog. This is very useful for reference in design and service work, as it gives the mechanical dimensions and electrical characteristics of all models in minute detail. *A. M. Flechtheim & Co.*

81. **I. R. C. RESISTOR CATALOG.** This sixteen-page catalog describes a very complete line of fixed resistors for radio purposes. It includes

full performance characteristics, so that a Service Man or an experimenter with a particular requirement in mind can select exactly the right unit for his purpose. A section in the back contains valuable data on the conversion of milliameters into ohmmeters and voltmeters, and on the extension of voltmeter and ammeter ranges. This catalog is well worth saving. *International Resistance Company.*

82. **MILES BULLETINS.** Bulletin J features midget and lapel microphones, home broadcast units and portable group-address amplifiers. The use of a lapel "mike" for faking in announcements on the family radio receiver is suggested as a home entertainment stunt. Bulletin M deals with simple private communication systems, for which there are big possibilities in offices, factories, homes etc. *Miles Reproducer Co.*

84. **POSTAL TUBE CHART.** Service Men and others who have been confused by the recent avalanche of new tubes will welcome this large chart, which shows the pin arrangement and socket connections of the latest types. It is very handy for reference purposes in the shop or out in the field. *Postal Radio Corp.*

85. **CONTINENTAL SUPPRESSORS.** This special bulletin describes suppressor resistors and condensers for automobile ignition systems. Some valuable suggestions for installing the devices and for eliminating interference are given. The method of using suppressors on a typical ignition system is illustrated. *Continental Carbon Inc.*

86. **YAXLEY AND ELKON CATALOGS.** The Yaxley catalog is valuable for the Service Man because it lists numerous rheostats, potentiometers, volume controls, replacement controls and resistances for service work. Detailed dimension drawings are included; this feature will be appreciated by every Service Man who has been called on to install replacement units in cramped receivers. Two pages of volume control replacement information are included, along with fourteen diagrams showing different circuit positions for such controls.

The Elkton catalog is devoted exclusively to dry electrolytic high voltage condensers for filter and bypass purposes. It too includes valuable replacement data on commercial receivers. *P. R. Mallory & Co.*

87. **OHMITE RESISTORS.** Hundreds of fixed resistors of different values and power rating are listed in this six-page bulletin. The following types are included: vitreous enameled fixed and semi-variable, meter multipliers, power rheostats, transmitting grid leaks and power pack units. A useful addition to every Service Man's and experimenter's file. *Ohmite Manufacturing Company.*

88. **PRECISION TYPE HIGH RESISTANCE UNITS.** This bulletin is devoted to special resistance units designed for applications where precision of value is an important consideration. For instance: television amplifiers, voltmeter multipliers, ammeter shunts, photo-cell circuits, sound head amplifiers, attenuators, decade boxes and resistance bridges. The tolerance of the units described is 1% plus or minus of the rated values. Resistors ranging from .25 ohm to 5 megohms are listed. *Precision Resistor Co.*

RADIO-CRAFT 5-88
Readers Bureau
96-98 Park Place, New York, N. Y.

Please send me free of charge the following booklets indicated by numbers in the published list above:

No.

Name

Address

City State.....

(Please check the following)

I am

(1) Service Man (2) Experimenter

(3) Dealer (4) Jobber

(5) Radio Engineer

(6) Licensed Amateur

(7) Professional or Amateur Set Builder

This coupon will not be honored unless you check off your classification above.

Hundreds of these Short Wave Sets are sold each week!

POWERTONE BATTERY-OPERATED SHORT WAVE RECEIVERS —15 TO 200 METERS

GOING FAST

YES, stronger than ever, so do we voice our and countless other opinions on this remarkable short-wave battery operated receiver. Faster than ever in sales volume, for the public has caught up with us in voicing their enthusiasm on results with this receiver. Never before has reception such as this been available on any two or three tube battery operated shortwave set.

The use of the new two volt, air cell, tubes increase reception sensitivity, and selectivity, furthermore current consumption is kept at a minimum. Provisions are made within the receiver to reduce three volts to two so that dry cells can be utilized. The set itself is made up of the best parts avail-

able including a Hammarlund condenser for tuning purposes. The parts are sturdily mounted on a metal base, which in turn is placed into a beautiful crackle finished metal cabinet to completely shield its entire contents.

A set of four plug-in coils is furnished with the receiver and cover from 14 to 200 meters.

Truly does this set earn the statement "Round the World Reception."

Set of batteries, \$2.25

Set of R. C. A. licensed tubes, \$2.50.

\$ 9⁹⁵
WITH COILS

15 TO 45 METERS 45 TO 90 METERS 90 TO 150 METERS 150 TO 200 METERS



NEW — POWERTONE — NEW 3 STAGE P. P. 250 AMPLIFIER

P
O
W
E
R
F
U
L

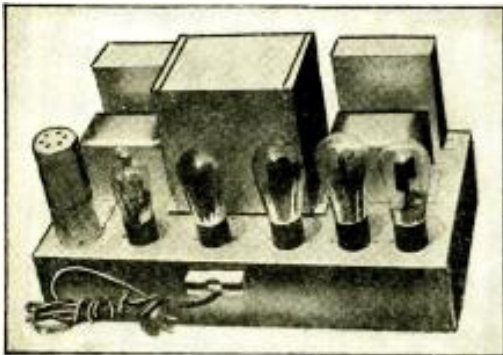

Q
U
A
L
I
T
Y

The Powertone Electric Co. points with pride to its new complete line of amplifiers and public address systems. Their new outfits boast of better quality at a better price.

The three stage amplifier pictured above is the finest of its kind available. It consists of 1-224, 1-227, 2-281 rectifying tubes and 2-250 push pull power amplifying tubes which insure maximum power output. The amplifier is so built that it can be used very well with either phonograph or microphone input.

The output will permit the use of four or five dynamic speakers which can be placed over a large area and give pleasing results.

Each amplifier is supplied with a fuse to prevent shorts consequently saving burning out of tubes and power transformer which in turn save the consumer time and expense.

The amplifier comes complete with a built in volume control with which the operator can control the volume from a whisper to the highest volume of sound or speech.

PRICE **\$ 24⁹⁵**
LESS TUBES

Complete set of R. C. A. licensed tubes, \$7.50

POWERTONE DIRECT COUPLED AMPLIFIERS



All the latest features have been incorporated in the NEW powertone direct coupled amplifiers. A microphone can be utilized with the proper transformer and dry cell batteries for public address systems, no input transformer is necessary for use with either radio set or phonograph for amplification purposes.

Model 245 uses 1-245, 1-224 and 1-280. Output is rated at 3 watts. Price less tubes..... **\$10.95**
Model 247 uses 1-224, 1-280 and 1-247. Output is rated at 2.5 watts. Price less tubes..... **\$12.95**
Model 250 uses 1-224, 1-281 and 1-250. Output is rated at 6 watts. Price less tubes..... **\$15.25**

JENSEN DYNAMIC SPEAKER CHASSIS



The tone and quality of these reproducers are unsurpassed. Will reproduce faithfully under the most trying conditions. These speaker outfits are available for all new type tubes as well as the old.

A.C. Types, D-7 Jr. Auditorium (as pictured) uses 280 rectifying tube in conjunction with 8 mfd. electrolytic condenser which insures minimum hum.

JENSEN—	
A.C.—D.8 Dry Rectifier.....	\$14.95
A.C.—D.7 Jr. Audit. Tube Rectifier.....	9.95
A.C.—D.15 Concert Jr. Tube Rect.....	7.50
D.9—2500 Ohm D.C. Field.....	6.95
D.7—2500 Ohm D.C. Field.....	7.50
D.15—Midret. 2500 Ohms.....	4.75

POWERTONE MIKE INPUT STAGE

This Microphone Input Stage Unit contains controls for microphone input transformer, microphone button current control and cutoff switch to preserve the life of the microphone. Frequency ranges from 30 to 7000 cycles. Input is standard microphone impedance; output 400,000 ohms. Complete shielding avoids feedback.

A handsomely finished black crackle steel box houses the unit. It is equipped with "on-off" switch for turning current off the microphone, also volume control with extra fine adjustment. Battery compartment holds one to four batteries.

For single button. Our Price **\$3.50**

For double button. Our Price **\$4.95**

BANQUET MIKE STAND

Extends from 18 to 30 inches. The ring will fit any standard size microphone. Due to a limited supply we advise you to get one at this low price.

Price. **\$3.50**



POWERTONE PORTABLE AMPLIFIER



A durable and powerfully constructed amplifier which is a complete public address system in itself. The case, which contains the amplifier, speaker, microphone transformer and all other accessories, can be carried around to any desirable location. A switch control in the rear enables one to use a Phonograph pickup or a microphone by merely throwing this switch without any additional appliances.

The amplifier comes complete with tubes. 1-224, 1-240, and 1-245, an R. C. A. microphone and a C battery for use with the microphone.

\$ 24⁵⁰
PRICE Complete

All offers are F. O. B. New York, and subject to prior sale. Terms: A deposit of 20% is required with every order. Balance may be paid on delivery. Or, deduct 2% if full amount is sent with order. Mention catalog number when ordering.

GRENPARK CO., Dept. R. C.

245 GREENWICH STREET, NEW YORK, N. Y.

SEND NO MONEY--

Clip and mail to us coupon below. We will send you either one or both books through the Express Company for your inspection. You have the privilege of keeping or returning them.

If you want to have a complete set of all Radio Diagrams, both manuals should be in your file.



Volume I, 1931 Edition



Volume II, 1932 Edition

Both volumes of the OFFICIAL RADIO SERVICE MANUAL will give you the most complete set of circuit diagrams ever published for the Radio Industry. Every Radio Service Man and Dealer should have them available for immediate use in his business. Professional set-builders and amateurs will find them instructive and helpful.

Briefly outlined below are the "high spots" that are to be found in the 1931 Manual—the first complete radio service manual ever to be published. Over twenty-seven thousand copies of this edition were sold to members of the radio industry. This assures you of its importance to those engaged in radio and how valuable it is to them.

Partial Contents

Wiring diagrams of radio sets manufactured since 1927, and many earlier ones of which there is no record elsewhere.

650 pages of radio-servicing material.

Complete course of instruction for Radio Service Men, dealers, manufacturers, jobbers, set builders and amateurs.

(Here are but a few of the subjects covered in the special course of instruction.)

- | | |
|------------------|----------------------|
| Amplifiers | Power-Supply Systems |
| Antennae | Radio Phonograph |
| Automotive Radio | Equipment |
| Condensers | Resistors |
| Detectors | Short-Wave Sets |
| Eliminators | Speakers |
| Meters | Tubes |

\$4.50 Complete with Supplements

650 PAGES

(Complete with Supplements)

Over 1,500 Diagrams, Charts and Illustrations

Get Supplements FREE with the NEW 1932 MANUAL

There is so much new material in this Manual, that a Service Man or dealer would be lost without it when called to service a set. Information about new models which have been on the market only a few weeks are contained in this book. The 1932 Manual makes the service kit complete.

The 1932 Manual contains a Full Radio Service Guide and a Complete Directory of all 1931-1932 Radio Diagrams, also models of older design. Everyone in the Radio business should have a copy. Send for yours today!

Partial Contents of Volume II

A step-by-step analysis in servicing a receiver which embodies in its design every possible combination of modern radio practice; it is fully illustrated and thoroughly explained. It is the greatest contribution to the radio service field.

Chart showing the operation of all types of vacuum tubes, whether new, old or obsolete. An exclusive resume of the uses of the Pentode and Variable-Mu Tubes and their characteristics.

Complete discussion of the superheterodyne and its inherent peculiarities. Also a special chapter on tools used on superheterodyne circuits. Schematic diagrams and circuits complete with color codings.

Important chapters on commercial aircraft radio equipment; new data on commercial short-wave receivers and converters.

Servicing and installation of public address systems and talking machine equipment.

Standardized color-codings for resistors.

Operation of old and new testing equipment; tube volt-meters, output meters, oscillators and aligning tools.

A full section on Midget radios—their design, circuits, and types. How to service them most economically.

Hundreds of schematic diagrams of older radio receivers which have never been published.

Blank pages for recording notes, diagrams and sketches; these pages are transferable to any part of the book.

Coupon page for free questions and answers.

\$5.00 Complete with Supplements

OVER 1,000 PAGES

(Including Supplements)

Over 2,000 Diagrams, Charts and Illustrations

Flexible, Looseleaf Binder, 9 x 12 inches.

CLIP COUPON AND MAIL TODAY!

GERNSBACK PUBLICATIONS, Inc. RC-12
96-98 Park Place, New York, N. Y.

Please send me for FREE inspection, the books I have checked below. I understand I may examine them carefully, and should I decide to keep them, I will pay the full cost, plus the few cents for carrying charges. This offer is good only in the U.S.A.

Volume I, 1931 Manual, with Supplement, \$1.50.

Volume II, 1932 Manual, with Supplements to be mailed Free every 60 days, \$5.00

BOTH BOOKS FOR \$9.00.

Name

Address

City State

NOT ONE OF THE DIAGRAMS PUBLISHED IN VOLUME NUMBER I OF THE OFFICIAL RADIO SERVICE MANUAL IS REPEATED IN VOLUME NUMBER II.

DECEMBER SPECIALS!!

EVERY month we list on this page certain **STAR** ★ items, which are NOT LISTED IN OUR CATALOG. These are all specials of which the quantities on hand are not sufficient to catalog them. *Once sold out, no more can be had.* First come, first served. **ORDER NOW, TODAY.**

STOP SHOPPING. The lowest prices are right on this page. *No one undercuts us.* We meet any price on ANY NEW Merchandise. Order direct from this page and save money. 100% satisfaction on every transaction. Take advantage of these special offers. **ORDER NOW, TODAY.**

G-M PHOTO-RELAY SWITCH For 110-20 Volts 60 Cycle A.C.

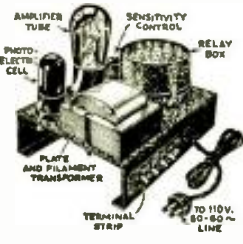

This new unit is an actual Photoelectric Relay containing all the principal parts used in the more costly industrial units. It comes fully equipped with a VISITRON Type B Caesium Cell, Magnetic Relay with special winding and silver contacts.

Transformer of large capacity, Amplifier Tube, Wire-Wound Potentiometer, Condensers, Terminal Strip, Sockets, Chassis, etc. This unit can be made the foundation of such photoelectric applications as burglar alarms, door-opening equipment, illumination control, race timing, counting, control of window displays and illumination, and myriad other installations. The Foto-Switch No. 1222A—Photo-Switch. **Your Price \$15.00**

"MEGADYNE" ONE-TUBE PENTODE LOUDSPEAKER RECEIVER KIT

In the front part of our catalog—get your FREE copy now—there is presented a thoroughly illustrated discussion on the construction and operation of the MEGADYNE Receiver by Hugo Gernsback, editor. This ingenious circuit was originally described in the July issue of the RADIO CRAFT Magazine. FREE copy of which will be given with each purchase. This receiver is indeed one of the most outstanding developments in the radio industry. It is the first real one-tube receiver which will actually operate a loudspeaker. Thousands of experimenters and radio fans will want to build this remarkable receiver. For their convenience, we have compiled a complete list of parts required for its construction. These parts are of the highest quality and are exactly as specified by the author. The following parts comprise the complete kit.



1 B.M.S. Fixed Crystal Detector; 1 6-ohm Filament Rheostat; 1 3-circuit tuner for use with a .0005 mf. tuning condenser; 1 Na-ald type 481 UY 5-prong socket; 1 Hammarlund type ML-23 Variable Condenser; 2 sets of Cinch double binding posts; 1 Polymet .00025 mf. fixed condenser; 1 X-L Variocoupler; 1 Polymet .00025 mf. fixed condenser, or 1 Polymet .0005 mf. fixed condenser. (NOTE: Only one of the latter two condensers is actually employed in the circuit); 5 Fahnestock binding posts; 1 25-ft. roll of hook-up wire; 2 black Bakelite 1 1/2" knobs; 1 Kurz-Kasch vernier dial with 0 to 100 scale reading clockwise; 1 type 38 pentode tube, "Triad" or "Speed"; 1 Bakelite Panel already drilled with all holes, size 7 x 10 x 3/16 inch; 1 hardware assortment. The wooden base is not included.

No. 2545—Megadyne Receiver Kit. **Your Price... \$10.25**

ELIMINATES NOISE AND CROSS-TALK

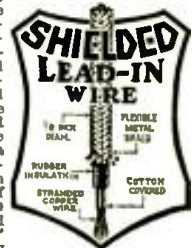

Service men throughout the world are beginning to realize the importance as well as the advantages obtained through the use of a shielded lead-in wire from antenna to radio receiver. More than 75 per cent of the complaints of "noisy" and "unselective" receivers may be eliminated by merely replacing the old, unshielded wire which leads from the aerial on the roof to the radio set with this new type of wire. Not only does it help to clear radio noises but to a certain extent, it makes the receiver more selective due to the capacity effect between the wire core and the metal shield. Easily installed. The wire core is connected between aerial on the roof and antenna post on receiver. The outer shield is connected to ground. Every service man should carry at least one spare roll of shielded wire in his service kit. No. 1665, 50 Ft. Roll **\$.85**
Shielded Lead-in Wire.. **\$.85**
No. 1668, 100 Ft. Roll **1.60**
Shielded Lead-in Wire.. **1.60**

★ "PEERLESS" DIRECT COUPLED AMPLIFIERS



All the latest features in amplifier design have been incorporated in this direct coupled amplifier. Input terminals for permitting phonograph attachment, and in addition, by attaching the proper microphone transformer, also dry cell batteries, a microphone may be used for public address work. Any type of receiver can be connected to the input terminals without fear of loss of energy. These amplifiers are for use with dynamic speakers.

Amplifiers supply field current of 2500 ohms to dynamic speakers. Resistors are furnished when A.C. speakers are used. Amplifiers operate on 110 volts, A. C., 60 cycles.
Model SP-5003 uses 1-224, 1-245 and 1-280. Output is rated at 3 watts.
No. SP-5003—Your Price.....\$10.95 (less tubes)
Exactly the same amplifier, but employs a power pentode in place of the 245 tube. Output 3.5 watts.
No. SP-5004—Your Price.....\$12.95 (less tubes)
Model SP-5005 uses 1-224, 1-250 and 1-281. Consumption is 35 watts; maximum undistorted output, 6 watts. Gain rated at 1000 cycles, 55db; gain at 10,000 cycles, 51.5. Input direct to 224 control grid; output direct from 250 plate.
No. SP-5005—Your Price.....\$15.25 (less tubes)

★ SYNCHROMATIC ELECTRIC CLOCK



Never was such a first class electric clock sold at such a ridiculously low price. An electric clock using the famous synchromatic movement. Naval observatory time right from your light socket! No spring to wind, no batteries. Never out of order. Lubricated for a life-time at the factory. Enclosed in a dust-proof and shockproof genuine molded Bakelite case. The case is of walnut-brown finish with simple but catching design. For 110 volts, 60 cycle A.C. operation only. Complete with cord and attachment plug. Size 3 1/4" x 1 1/2" x 1 1/2". Weight 1 lb. Service men now sell these fine clocks by the hundreds. Be the first in your locality to handle them.

List Price \$3.00
No. 1689—Synchromatic Electric Clock. **Your Price \$1.00**

FREE RADIO AND SHORT WAVE TREATISE

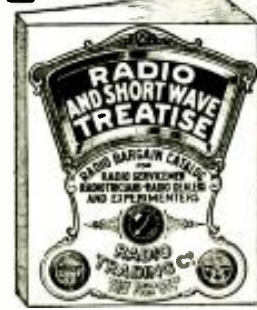

The new and enlarged Summer edition of our Radio and Short Wave Treatise, No. 25, has just come off the press—100 solid pages of useful information, radio items, diagrams and illustrations. Positively the greatest book in print—NOT JUST ANOTHER CATALOG. Contains a large editorial section with valuable information not found anywhere else. Considerable space is devoted to a TREATISE ON SHORT WAVES for both beginners and regular "hams." Among the new technical information listed are the following: Modernizing old radio sets—repairing speakers and headsets—making superhets out of old sets—data on constructing two-volt battery and automobile receivers—circuit of the famous Gernsback Megadyne One-Tube Loudspeaker Set—short wave coil winding data—discussion on S.W. adapters, converters and receivers, etc., etc.

100 New Hook-Ups, Etc. 1000 Illustrations.

WRITE TODAY. Enclose 4 cents for postage. Treatise sent by return mail.

★ SILVER-MARSHALL AUDITORIUM AMPLIFIER



Ideal for theatres seating approximately 3,000 people, dance halls, schools, lectures, hospitals, auditoriums, outdoor gatherings, etc., etc. The gigantic power is at all times within control—for that matter it can be used in any home, as the volume can be regulated down to a whisper! Supplies all necessary A, B and C. power to its own tubes. Operation requires one type X250 power tube, one X226 A.C. tube and two type X281 rectifier tubes. Attractive crystalline finish metal cabinet. 21x5 1/2 x 5 1/2. Shipping weight, 38 lbs. **Your Price... \$12.75**

★ METALLIZED PIGTAIL RESISTORS AT ROCK BOTTOM PRICES

A very fortunate purchase enables us to offer these fine resistors at prices which surprise even ourselves—prices more than three times lower than in our own catalog. Resistors are guaranteed to maintain their ohmage under even adverse operating conditions. The resistance element is based on the famous metallized principle which has proven its superiority wherever accuracy and uniformity are paramount requisites. The special ceramic casing of these resistors is of sturdy construction and affords maximum heat dissipation. A feature of these resistors is their molded end-caps, tapered so they can be mounted in all standard resistor mounts. By means of their pigtails, they may also be soldered in any convenient position. Available in the following sizes—all rated at one watt: 800, 450, 600, 8,000, 10,000, 12,000, 350,000. Act fast to take advantage of this offer, as the supply is limited. Sold only in lots of six or more.



Values Clearly Marked on Each Unit
No. SP2226, Metallized Resistors. NOW YOUR PRICE..... **6c**
12 for 60c. EACH

★ PORTABLE PUBLIC ADDRESS SYSTEM

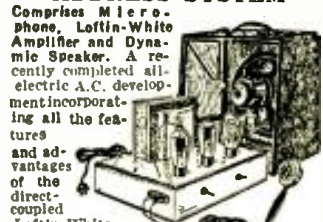

Comprises Microphone, Loftin-White Amplifier and Dynamic Speaker. A recently completed all-electric A.C. development incorporating all the features and advantages of the direct-coupled Loftin-White Amplifier principle. The amplifier is a high quality two stage job, having some RADICALLY NEW IDEAS IN AUDIO FREQUENCY AMPLIFICATION and employing 1-27, 1-35 power tube and 1-80 full-wave rectifier. It is remarkably free from A.C. hum. The design is adaptable to all purposes, i.e., microphone, radio and phonograph. Has an undistorted power output of approximately 3.5 watts; SUFFICIENT TO OPERATE FROM 2 TO 3 ADDITIONAL DYNAMIC SPEAKERS. The portable address system is sold COMPLETE WITH THE NEW R.C.A. VICTOR HAND MICROPHONE. Put up in a single compact and perfectly balanced carrying case, the front of which is utilized as a baffle for the self-contained dynamic speaker. Complete with microphone and accessories the weight is only 30 pounds. For 50-60 cycles, 110-120 volts A.C. operation, shipping weight, 38 pounds. List Price, \$75.00
No. SP-5011—Versatile Portable Address System Your Price, com- **\$24.95**
plete with microphone...



★ PRIME "GREEN GIANT"

Electric Phonograph Motor
Induction type model with newly improved, humless motor. Equipped with speed regulator, also "on and off" switch. Completely equipped with large turn-table—takes records up to 12" in diameter. An ideal motor for electrifying the old phonograph. When used in conjunction with any amplifier on this page superb electrical reproduction is obtained.
No. 100—Your Price..... **\$7.50**

WE ARE A WHOLESALE HOUSE AND CANNOT ACCEPT ORDERS FOR LESS THAN \$3.00.
If C. O. D. shipment is desired, please remit 20% remittance, which must accompany all orders.
If full cash accompanies order, deduct 2% discount. Send money order—certified check—U. S. stamps.

Radio Trading Co.
23 West Broadway
New York, N. Y.

ORDER FROM THIS PAGE. You will find special prices from time to time in this magazine. Get our big FREE catalog for the greatest Radio Bargains. Should you wish goods shipped by parcel post, be sure to include sufficient extra remittance for same. Any excess will be refunded.

RADIO SERVICEMEN and DEALERS

Here's the Catalog

★ **THAT HAS BECOME A**

RADIO INSTITUTION!



It started—just 11 years ago—as an ordinary mail order radio catalog. Undoubtedly you've seen the kind—there are lots of them around today. But the first crude catalog of 11 years ago had the same purpose behind it that today's magnificent WHOLESALE CATALOG has—to sell everything the radio service man and dealer needs at the lowest prices—to give him unexcelled service!

Perhaps that is the reason why, after 11 years of phenomenal progress, the WHOLESALE RADIO SERVICE CATALOG is read by more people—serves more customers—has the largest and greatest circulation of any radio catalog ever issued. It has spread all over the world—its issuance is a matter of interest to the radio industry at large—it has truly become a radio institution—a book that is responsible for more business than any piece of printed literature ever produced in radio.

★ 11 Years of Radio Reliability

It goes without saying that the company behind such an undertaking grew and kept pace with its offspring—became institutionalized in the same sense that its catalog did. For 11 years WHOLESALE RADIO SERVICE COMPANY has maintained a reputation as the “reliability house of radio.” During business storms and business wars—prosperity booms and depressions—fair competition—imitators by the scores—our business has grown—our facilities constantly expanded—until today WHOLESALE RADIO SERVICE COMPANY is the largest institution of its kind in the world.

★ Coupon Brings Catalog!

Growth of this kind must have a powerful, vital force in back of it. No business can make such tremendous strides unless it has a guiding policy that has met with the approval of its customers. You can discover these reasons for yourself—by examining our catalog or by doing business with our company. The catalog will show you an 11 year old policy—to sell the finest radio merchandise at the lowest WHOLESALE prices. Your very first transaction will illustrate our adherence to the slogan—the fastest, quickest, most reliable service in all radio!

We suggest—mail the coupon below for your FREE catalog.

WHOLESALE RADIO SERVICE CO.,
100 Sixth Ave., Dept. G-55,
New York, N. Y.

I shall be glad to receive a FREE copy of your new 1933 radio catalog. Please mail it immediately.

Name.....

Address.....

Town..... State.....

One of This Catalog's Many Features— LAFAYETTE perfected PUBLIC ADDRESS SYSTEMS and AMPLIFIERS

This year there has been more interest—and more business—in public address systems and amplifiers than ever before in the history of radio. Recognizing that fact we have listed in our new catalog the most advanced types of public address equipment and amplifiers. For example, the new LAFAYETTE LOFTIN-WHITE “CLASS B” AMPLIFIER will drive 20 full size dynamic speakers. This is the first amplifier to combine the advantages of the Loftin-White principle with the tremendous power

gain of the recently developed “Class B” circuit.

The new LAFAYETTE 250 PUBLIC ADDRESS SYSTEM, with Loftin-White “250” Push-Pull Amplifier, is the most modern type equipment available today—at prices startlingly low.

Microphones—amplifiers—complete equipment of all kinds—everything the radio service man needs to increase his earnings in a rapidly growing field. Full details and descriptions in our catalog—write for it.

**WHOLESALE RADIO
SERVICE CO., INC.**
100 SIXTH AVE. NEW YORK

A Service Man's Proportional-scale Ohmmeter

FRANK ZOLTOWSKI

WITH resistance values ranging commonly between 50 and 100,000 ohms, it becomes quite a problem to the Service Man to check up on them even if we quite neglect speed and accuracy; his needs call for an ohmmeter of very wide range. However, the instrument should be fairly accurate, fast in operation, small in size and of low cost.

After much figuring and dopping the writer came to the conclusion that the only way to secure a sufficiently wide range of resistance measurements with the apparatus available was by using the voltmeter and ammeter method. By this system of connections, Fig. 1A, it is possible to find the value of an unknown resistance by dividing the applied voltage by the observed current.

Following a number of measurements with this set-up, the thought arose that it would be nice to have a smooth, variable source of applied voltage, so that the voltage could be adjusted until the current was an easy decimal quantity. For instance, we take an unknown resistance and connect it in position as in Fig. 1B, and by means of the variable voltage divider, the potentiometer, we adjust the voltage until the milliammeter reads .001-A. Now we observe on the voltmeter the amount of voltage required to pass .001-A. through the resistor; in this case, we will say, it is two volts, therefore.

$$R = \frac{E}{I} \text{ or } 2 \div .001 = 2,000 \text{ ohms.}$$

Easy? You do not have to do it on paper, just simply read the voltage and then in your mind point off three places. To divide by .001 is the same as multiplying by 1,000 and to multiply by 1,000, point off three places to the right. Thus, to find the value of an unknown resistance, just connect in the "unknown," adjust the voltage, multiply by 1,000, and there is your answer in ohms.

Now think a minute—if we are going to keep our current at .001-A., when making a measurement, then it is going to take 1 V. to push it through 1,000 ohms, 2 V. for 2,000 ohms, 3 V. for 3,000 ohms, and so on up the scale. Now if that is the case you are getting your ohm readings direct from the scale of the voltmeter (times 1,000) and that is a straight-line scale—something out of the ordinary for ohmmeters.

So far we have done pretty well and we have about decided that the ammeter in this arrangement will have a full-scale value of 1 ma. If it takes 1 V. per thousand ohms to operate the meter then it will require 100 V. to reach our high ideal of 100,000 ohms.

A battery of this rating would constitute too much bulk and weight. Let us decide that three of the regular 4.5 V. "C" battery units are all that we can carry or conveniently put in the case; this will give us a maximum of 13.5 V. and if we allow for "wear" we should always be able to obtain 10 V. from them. We will use a voltmeter with a range of 10 V. (any internal resistance) to read the voltage impressed on the unknown resistance.

Although it seems that our range in measuring ohms will be limited to 10,000, this need not necessarily be the case, because there is another way out. Instead of adjusting the voltage until the milliammeter reads .001-A., just adjust it to one-tenth of the scale or .0001-A., then multiply the reading of the voltmeter scale by 10,000 instead of 1,000. This means that if .0001-A. is flowing at a voltage of 10 then the resistance in the circuit has a value of 100,000 ohms.

Perhaps you are beginning to see now that the ammeter serves principally as a multiplying indicator telling you by how much to multiply the volt scale in order to read directly the ohms in the circuit.

We have found how to get two ranges with the instrument: 0 to 10,000 by using a multiplying factor of 1,000 and: 0 to 100,000 by using a multiplying factor of 10,000. We can extend this multiplying scheme a little more and get an advantage in widening the range between 0 and 1,000 ohms so as to make it more readable. This is accomplished by placing a multiplying shunt on the milliammeter so as to give it a range of 10 ma., or .01-A. With the shunt switched in we adjust the multiplying indicator to full-scale and multiply the reading on the "volt" scale by 100. We will thus be able to read clearly from 50 to 1,000 ohms.

A circuit of the completed instrument is shown in Fig. 1C. A switch is provided to cut off the 400 ohm voltage divider so that it will not bleed the batteries when not in use. The pilot light P. L. is a further precaution against leaving the switch in the "on" position when the instrument is not in use. The better the meters used, of course, the greater will be the accuracy. A suggested arrangement of the apparatus is shown in Fig. 1D.

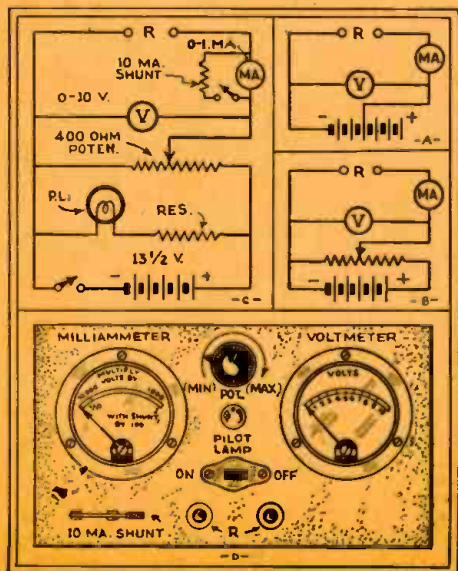

Fig. 1. Ohmmeter circuits; and layout.

POST CARD

PLACE
1c
STAMP
HERE

WHOLESALE RADIO SERVICE CO

Dept. G55
100 Sixth Avenue
NEW YORK, N. Y.

POST CARD

PLACE
1c
STAMP
HERE

Lincoln Radio Corporation

Dept. RC-12
329 South Wood Street
CHICAGO, ILLINOIS

POST CARD

PLACE
1c
STAMP
HERE

Newark Electric Company

226 West Madison Street
CHICAGO, ILLINOIS

POST CARD

PLACE
1c
STAMP
HERE

Cable Radio Tube Corp.

230-242 North 9th Street

BROOKLYN, NEW YORK

How to Get "Java" With a Simple P. A. System

PAUL RICHARDS

MODERN ingenuity has solved the problem of serving a greater number of customers than ever before, in the Loft candy store at 251 W. 42nd St., New York City, through the use of a public address system of very simple design, as shown in Fig. A. Service Men will do well to take the tip—store owners everywhere are willing to consider any reasonable proposition which will enable them, without exorbitant expense, to secure increased return from the same floor space.

Pretty waitresses tend a counter devoid of everything but water spigots, as shown in the upper portion of Fig. A; soda fountains, drink mixers, ice cream tanks, coffee urns, and the short-order counter, attended by clerks, all are located in the basement, as shown in the lower portion of the view.

As the customer gives the order, the waitress repeats it into one of six Universal, type X chrome-plated two-button microphones, which are mounted in Universal type Banquet chrome-plated microphone stands; two of these appear in Fig. A. Microphone current is obtained from equipment in the basement; an "off-on" button is provided at each microphone stand and must be operated whenever an order is to be given.

The output of each pair of microphones terminates in the basement at special amplifier-reproducer cabinets. These three units appear in the lower portion of Fig. A; each instrument is permanently connected to a 110 V., A.C. outlet. Within each cabinet are contained a Wright-DeCoster dynamic reproducer; a Universal type 1089 two-button microphone transformer, and; an Electrad type B-250 Loftin-White direct coupled amplifier. The schematic circuit of the latter unit is Fig. 1.

The power consumption of this amplifier is 85 W.; the maximum undistorted power output, 4.6 W. Additional specifications are as follows: Gain at 100 cycles, 52.5 db.; 1000 cycles, 55 db.; 10,000 cycles, 51.5 db. Input potential for maximum output, 0.28-V.; hum level, 0.4-V.

A high-speed dumbwaiter alongside each clerk promptly carries the completed order to the floor above.

Thus, modern magic has opened for the technician one more lucrative field. Every store owner who feels that the street-level floor space for which he pays a high rental is not adequate to meet his needs, will do well to consider the possibility of adapting available low-rental space above or below, through the use of a simple public address system.

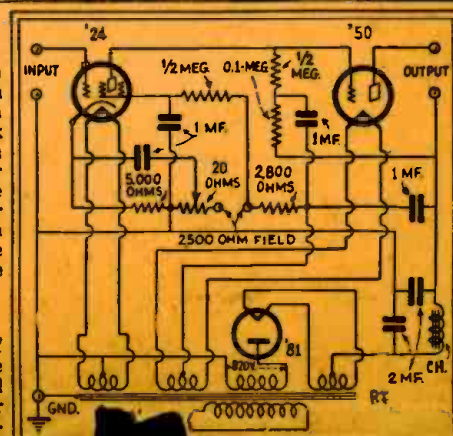

Fig. A, above.

In the upper portion of this view are shown microphones into which pretty waitresses in a Loft store in New York City pass to the room below the order for "Java and —." The amplifier-reproducer cabinets in the room below appear in the lower section of the figure.

Fig. 1, right.

Schematic circuit of the Electrad type B-250 direct-coupled "L-W" type amplifier contained in the cabi-



free! *The Great New*
WHOLESALE
RADIO Catalog!
Smashing Selection
of 1933 Values!

December RADIO-CRAFT
Wholesale Radio Service Co., Inc.,
100 Sixth Avenue,
New York, N. Y.

Attention: Dept. G55
I shall be glad to receive a **FREE** copy of your
NEW 1933 Radio Catalog. Kindly mail it im-
mediately.

Name _____
Address _____
Town and State _____

December RADIO-CRAFT

Lincoln Radio Corporation
Dept. RC-12, 329 South Wood Street
Chicago, Illinois

Please send me information on () A. C. () D. C. receivers.

Name _____

Address _____

City _____ State _____

December RADIO-CRAFT

Newark Electric Company
226 West Madison Street
Chicago, Illinois

Please send me information about TOBE FILTERIZERS.

Name _____

Address _____

City _____ State _____

December RADIO-CRAFT

Cable Radio Tube Corp.
230-242 North 9th Street
Brooklyn, New York

Gentlemen: Please send me current bulletins without charge
or obligation on the items checked:

- () SPEED Radio Tubes () SPEED Foto-Lectric Tubes
() SPEED Television Tubes () SPEED Triple-Twin Group

Name _____

Address _____

City _____ State _____